



MedCaster™

Acorn Industrial Products Co

Phone: 800-523-5474

E-mail: acorn@acornindprod.com

www.acornindprod.com

*Manufactured with the greatest care
for the medical industry*

- QUIET
- CLEAN
- SMOOTH



ANTIMICROBIAL CASTERS & WHEELS

How Does It Work?

The compound used in our antimicrobial wheels, thread guards and forks is designed to suppress the growth of a variety of destructive and odor causing microbes including bacteria, molds, mildew, and fungi. The active ingredients neutralize the ability of microbes to function, grow and reproduce.

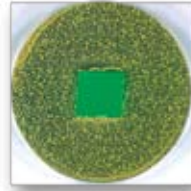

Standard wheel material

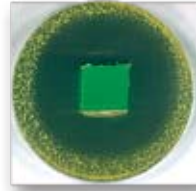

Wheel with antimicrobial compound



How long does the protection last?

Antimicrobial wheels are engineered to be effective against microbes for the life of the wheel. The agent remains stored in the polymer and is gradually released to the surface of the wheel.

and enhance your ongoing program. Good hygiene practices should always be observed.

Is the antimicrobial compound safe?

Yes. The active ingredients have undergone extensive laboratory testing and have been proven safe. The active ingredient has a history of hospital use for more than 25 years and is used in a broad range of popular personal care products, such as antimicrobial soap, toothpaste and deodorant. It is registered with the US Environmental Protection Agency (EPA), and products with this material have been approved by the US Food & Drug Administration (FDA), the European Union (EU), the National Sanitation Foundation (NSF) and other regulatory authorities around the world.

Will scratches, tread wear or wax buildup diminish the effectiveness?

No. Antimicrobial wheel protection is not a coating on the surface of the wheel, thread guard or fork. It is an integral part of the product. Abrasion, chips or scratches will not impact the effectiveness in any way. Not even wax buildup on the wheel can impair the bacteria fighting performance.

Does the antimicrobial compound eliminate the need for cleaning?

No. Although antimicrobial compound provides an added level of protection, this does not eliminate the need for normal cleaning practices. They are designed to work in conjunction with



NG Antimicrobial (pages 58-69)



Antimicrobial wheel available for Chrome Hospital (CH) and Stainless Steel (SS) casters.

ANTISTATIC CASTERS

Electronic equipment can be damaged by the electrostatic discharge of a simple human touch. Damage caused by this discharge is very costly and frustrating to the medical industry. MedCaster antistatic casters and wheels can help minimize the risk of electrostatic discharge. Our antistatic casters and wheels conform to CEN standards with resistance values < 10,000 ohms (measured at 500V DC, with minimum output of 50 V DC at 1,000 ohms resistance).



NA Antistatic



PA Antistatic



CH & SS Antistatic



Rhombus 367 & 364 Antistatic

New Section: See pages 92-97

CONTENTS

MedCaster Inc. is focused on the manufacturing and supply of casters and wheels to the Medical and Pharmaceutical industries. Our broad line of products and expertise allows us to meet our customer's needs. MedCaster can also design and produce casters and wheels that meet your specific requirements such as custom colors or other specifications. Please contact us toll free at 1-866-462-9700 or email us at info@medcaster.com.

Caster Fitting Guide	4-5
Medcaster Model Numbering System.....	6

MEDCASTER DOUBLE WHEEL CASTERS

Dual Wheel Casters (DW)	7
Twin Wheel Casters (TW).....	8
Grey Tech Casters (GT).....	9
MediMaster (MM)	10
NeoTeq Chrome Dual (DN).....	11
Twin-Med (TM)	12-13
Dual Wheel (MF)	14
Kick-Stop (KS)	15

MEDCASTER MULTI-PURPOSE CASTERS

Streamline (SL)	16
Solus Tech (ST)	17
NeoTeq (CN).....	18-19
Razer (RZ).....	20-23
Chrome Hospital (CH).....	24-35
Chrome Steel (CS).....	36-45
Stainless Steel (S S) 1-1/4" Tread Width	46-51
Stainless Steel (SS) 2" Diameter	52-53
Autoclave (AC)	54-55

MEDCASTER NYLON/PLASTIC CASTERS

Plastic Caster Introduction	56-57
Nylon Next Generation (NG)	58-59
Light Grey (ND)	
Dark Grey (NB)	
Black (NK)	
Antimicrobial (NG)	58-69
Nylon Plus Stainless (NS)	70-77
Marquee (MQ).....	78-83
Plastic (PG)	84-91

New! MEDCASTER Antistatic Casters

Antistatic Introduction	92
Chrome Hospital (CA).....	93
Chrome Stainless (SS)	93
Nylon Antistatic (NA)	94
Rhombus 367 & 364 Antistatic.....	95
Plastic Antistatic (PA)	96-97

MEDCASTER HOSPITAL BED CASTERS

Hospital Bed Caster Introduction	98
Med-Bed (MB)	99
Hospital Bed Chrome (HC).....	100-101
Hospital Bed Stainless Steel (HS)	102-103
Med-Ultra (MU)	104
Twin Tech Ultra (TU)	105
Bed Assessoris.....	106

Rhombus Casters

Rhombus Introduction.....	107
Nimbus 399.....	108-109
Bariatric 389.....	110-111
Rhombus 390/390+	112-113
Rhombus 391/391+ Precision	112-113
Rhombus 367 & 364.....	114-115

MEDCASTER SPECIALTY CASTERS & Accessories

Wheels	116-119
Wheel Chair Caster (WC) (WW).....	120
Bumpers.....	121
NEW! Caster Sockets and Hardware.....	122
Specialty / Inches to Metric Conversion.....	123

New Products!



New Sockets and Hardware



New Rhombus Section Pages 107-115



CASTER FITTINGS GUIDE



HOLLOW KINGPIN

Suffix No.	Dimensions	DW	DN	CN	CH	CS	SS	NG	NS	PG	PA	RZ
HK01	1/2" ID	✓	✓		✓	✓	✓	✓	✓	✓	✓	
HK02	12mm ID									✓		
HK04	7/16" ID			✓				✓	✓			✓



EXPANDING ADAPTER STEMS

Suffix No.	Dimensions	CH	CS	SS	NG	NS	PG	PA
Round Nylon Expanding Adapters								
XRN1	3/4" x 2-1/4"	✓	✓	✓	✓	✓	✓	✓
XRN2	13/16" x 2-1/4"	✓	✓	✓	✓	✓	✓	✓
XRN3	7/8" x 2-1/4" round	✓	✓	✓	✓	✓	✓	✓
XRN4	1" x 2-1/4"	✓	✓	✓	✓	✓	✓	✓



Round Rubber Expanding Adapters

XRR1	3/4" x 2-1/4"	✓	✓	✓	✓	✓	✓	✓
XRR2	7/8" x 2-1/4"	✓	✓	✓	✓	✓	✓	✓
XRR3	1" x 2-1/4"	✓	✓	✓	✓	✓	✓	✓
XRR4	1-1/8" x 2-1/4"	✓	✓	✓	✓	✓	✓	✓
XRR5	1-1/4" x 2-1/4"	✓	✓	✓	✓	✓	✓	✓
XRR6	1-3/8" x 2-1/4"	✓	✓	✓	✓	✓	✓	✓
XRR7	1-1/2" x 2-1/4"	✓	✓	✓	✓	✓	✓	✓
XRR8	1-5/8" x 2-1/4"	✓	✓	✓	✓	✓	✓	✓



Round Zamac Expanding Adapters

XRZ1	21/32" x 2-1/4"	✓	✓		✓	✓	✓	✓
XRZ2	3/4" x 2-1/4"	✓	✓		✓	✓	✓	✓
XRZ3	7/8" x 2-1/4"	✓	✓		✓	✓	✓	✓
XRZ4	1" x 2-1/4"	✓	✓		✓	✓	✓	✓
XRZ5	1-3/32" x 2-1/4"	✓	✓		✓	✓	✓	✓

Square Zamac Expanding Adapters

XSZ1	25/32" x 2-1/4"	✓	✓		✓	✓	✓	✓
------	-----------------	---	---	--	---	---	---	---



CENTRAL LOCKING STEMS

Suffix No.	Dimensions	MB	TU	HC	HS	MU
CL01	27.8mm x 98mm*	✓	✓	✓	✓	✓
CL02	32mm x 54mm	✓	✓	✓	✓	✓
CL03	27.8mm x 98mm	✓	✓	✓	✓	✓
CL04	32mm x 54mm	✓	✓	✓	✓	✓

*HP, HC, HS, MU are 27.8 mm x 96mm.



SWIVEL TOP PLATES

Suffix No.	Dimensions	DW	CN	CH	CS	SS	NG	NS	PG	PA	RZ	GT	TM	DN	SL	AC	MQ
TP01	2-1/2" x 3-5/8"	✓	✓	✓	✓	✓	✓	✓	✓	✓	✓		✓	✓	✓	✓	✓
TP02	1-1/4" x 2-3/8"			✓													
TP03	4" x 4-1/2"					✓											
TP04	2.65" x 3"	✓	✓				✓										
TP05	2.36" x 2.36"											✓					
TP06	2.12" x 2.12"											✓					
TP07	1-1/2" x 1-1/2"																
TP08	2-3/4" x 2-5/8"												✓	✓			
TP09	2-3/16" x 2-9/16"																
TP10	80mm x 105mm																
TP11	3" x 2-5/8"	✓											✓	✓			
TP12	5" x 5.5"					✓											
TP13	96mm x 70mm		✓													✓	

Caster Series

- AC** Autoclave
- CH** Chrome Hospital
- CN** Chrome Neoteq
- CS** Chrome Steel
- DW** Dual wheel
- DN** Neoteq Dual
- GT** Grey Tech
- HC** Hospital Bed Chrome
- HP** Hospital Bed Plastic
- HS** Hospital Bed Stainless
- KS** Kick Stop
- MB** Med-Bed Casters
- MF** Multi-Function
- MM** MediMaster
- NM** Non-Magnetic
- MQ** Marquee
- MU** Med-Ultra
- NA** Nylon Antistatic
- ND** Nylon Dark Gray
- NG** Nylon Light Gray
- NK** Nylon Black
- NS** Nylon Plus Stainless
- PA** Plastic Antistatic
- PD** Plastic Dark Gray
- PG** Plastic Light Gray
- RZ** Razer
- SL** Streamline
- SS** Stainless Steel
- ST** Solus Tech
- TM** Twin-Med
- TW** Twin Wheel
- WC** Wheel Chair Casters
- WO** Misc. Wheel Only
- WW** Wheel Chair Wheels

Continue next page

CASTER FITTINGS GUIDE

ROUND STEMS



Suffix No.	Dimensions	CH	CS	NG	PG	PA	MB	TU	HC	HS	MU
RS01	22mm x 45mm	✓	✓	✓	✓	✓					
RS02	25.4mm x 45mm	✓	✓	✓	✓	✓					
RS03	27.8mm x 45mm	✓	✓	✓	✓	✓	✓	✓	✓	✓	✓
RS04	20.5mm x 45mm	✓	✓	✓	✓	✓					
RS05	32mm x 45mm	✓	✓	✓	✓	✓	✓	✓	✓	✓	✓

SQUARE STEMS



Suffix No.	Dimensions	CH	CS	NG	PG	PA	AC
SQ01	3/4" x 2" no holes	✓	✓	✓	✓	✓	
SQ02	1" x 1.75" 3 holes	✓	✓	✓	✓	✓	
SQ03	.850" x 2.2" grip ring	✓	✓	✓	✓	✓	
SQ05	7/8" x 3-1/2" square						✓

GRIP RING STEMS



Suffix No.	Dimensions	TW	CN	CH	CS	NG	NS	PG	PA	RZ	GT	NM	SS	SL	AC	MQ
GR01	7/16" x 7/8" round	✓	✓	✓	✓	✓				✓	✓	✓				✓
GR02	7/16" x 1-7/16" round	✓	✓	✓	✓	✓				✓	✓	✓	✓			✓
GR03	3/8" x 7/8" round															
GR04	5/8" x 1-5/8" round			✓	✓	✓		✓	✓							
GR05	3/4" x 1-5/8" round			✓	✓	✓		✓	✓							
GR06	7/8" x 2" round			✓	✓	✓		✓	✓							
GR07	1" x 1-7/8" round			✓	✓	✓		✓	✓							
GR08	7/16" x 1-29/32" round								✓		✓					
GR09	.845" x 2-3/16" round			✓	✓	✓		✓	✓					✓		✓
GR10	7/16" x 1-3/8" round			✓	✓	✓		✓	✓							
GR11	.845" x 2-3/16" round*						✓						✓		✓	✓
GR12	7/16" x 1-15/16" round					✓										

*Stainless

THREADED STEMS



Suffix No.	Dimensions	TW	CN	CH	CS	SS	NG	NS	PG	PA	ST	KS	MM	TM	WC	RZ	GT	NM	MF	SL	MQ
TS01	1/2"-13NC x 3/4"			✓	✓		✓		✓	✓									✓		
TS02	1/2"-13NC x 1"	✓		✓	✓		✓		✓	✓				✓			✓		✓	✓	✓
TS03	1/2"-13NC x 1-1/2"	✓		✓	✓		✓		✓	✓				✓			✓				✓
TS04	1/2"-13NC x 2"			✓	✓		✓		✓	✓											
TS05	7/16"-14NC x 1-3/4"			✓	✓		✓		✓	✓											
TS06	3/8"-16NC x 1"	✓	✓											✓		✓	✓				
TS07	M12 x 1"			✓	✓		✓		✓	✓									✓		
TS11	1/2"-13NC x 3/4"*			✓	✓		✓		✓	✓											
TS12	1/2"-13NC x 1"*			✓	✓		✓		✓	✓											
TS13	1/2"-13NC x 1-1/2"*			✓	✓		✓		✓	✓											
TS14	1/2"-13NC x 2"*			✓	✓		✓		✓	✓											
TS15	M10 x 19/32"										✓	✓		✓		✓					
TS16	M12 x 25/32"										✓	✓									
TS17	M14 x 7/8"																				
TS18	M16 x 25/32"													✓	✓	✓					
TS19	M12 x 1-1/8"													✓							
TS20	M10 x 43/64"									✓											
TS21	M12 x 60mm			✓			✓														
TS22	1/2"-13NC x 2-11/16"			✓			✓														
TS23	M12 X 15mm													✓							
TS24	3/8"-16NC x 3/4"																	✓	✓		
TS25	3/8"-16NC x 1-1/2"																✓				

*Stainless

MEDCASTER MODEL NUMBERING SYSTEM

Below example is a Nylon Light Grey (NG) caster that has a 5" diameter QuickStart wheel with a dark grey tread, thread guard and Precision Ball bearing. The tread width is 1-1/4" wide. The fork type is swivel. The fitting type is threaded stem (1/2"-13NC x 1-1/2").

NG - 05 QDP - 125 - SW - T S 03

Caster Series

AC Autoclave	ND Nylon Dark Gray
CH Chrome Hospital	NG Nylon Light Gray
CN Chrome Neoteq	NK Nylon Black
CS Chrome Steel	NS Nylon Plus Stainless
DW Dual wheel	PA Plastic Antistatic
DN Neoteq Dual	PD Plastic Dark Gray
GT Grey Tech	PG Plastic Light Gray
HC Hospital Bed Chrome	RG Razer
HP Hospital Bed Plastic	SL Streamline
HS Hospital Bed Stainless	SS Stainless Steel
KS Kick Stop	ST Solus Tech
MB Med-Bed Casters	TM Twin-Med
MF Multi-Function	TM Twin-Med Ultra
MM MediMaster	TU Twin-Tech
NM Non-Magnetic	WC Wheel Chair Casters
MQ Marquee	WO Misc. Wheel Only
MU Med-Ultra	WW Wheel Chair Wheels
NA Nylon Antistatic	

Wheel Type

AM Anti-Microbial TPR	PW White Polyurethane
AP Anti-static Polyurethane	PY Polyurethane TPU
AR Anti-static Rubber	QB QuickStart (dark grey tread with black thread guard)
AT Anti-Static TPR	QD QuickStart (dark grey tread and thread guard)
EP MedEagle	QL QuickStart (light grey tread and thread guard)
HR High Temp Rubber	RM Rubber on Metal
GR Grey rubber	RP Rubber on Plastic
CR Conductive Rubber	RR Rubber on Rubber
NR Neoprene Rubber	TP Thermoplastic Rubber
HS Hytrel on PP	
NY Nylon	
PB Polyurethane Black	
PH Phenolic	
PP Polyolefin	
PS Polyurethane Solid	

Wheel Diameter

01 1	06 6
02 2	07 7
03 3	75 7.5
35 3.5	08 8
04 4	24 24
05 5	

Bearing Type

A Annular
B Ball
D Delrin
N Plain, Nylon
O Plain Bore
P Precision
R Roller
S Stainless Roller
X Stainless Precision

Tread Width

025 .25
050 .50
075 .75
100 1
125 1.25
150 1.5
200 2

Fork Type

DL Directional Lock
DT Direction/Total Comb.
RB Rigid Brake
RG Rigid
SB Side Brake
SW Swivel
TB Top Brake
TL Total Lock

Fitting Code

See page 3-4 for stem codes

Fitting Type

GR Grip Ring
HK Hollow Kingpin
OS Octagon Stem
RS Round Stem
SP Special
SQ Square Stem
CL System Stem
TP Top Plate
TS Threaded Stem
XR Expanding Round
XS Expanding Square

FORK/RIG NUMBERING SYSTEM

Fork/Rig models are similar to caster models except there is no wheel code. Below is an example of a fork/rig only model for a 5" diameter by 1-1/4" tread width wheel. The fork type is swivel. The fitting type is threaded stem (1/2"-13NC x 1-1/2").

NG-05 - 125 - SW-T S03

WHEEL NUMBERING SYSTEM

Wheel replacement models are similar to caster models except the last 2 digits. Below example is a wheel for a Nylon Light Grey (NG) caster that has a 5" diameter QuickStart wheel with a dark grey tread, thread guard and Precision Ball Bearing. The tread width is 1-1/4" wide. The axle is 5/16".

NG-05 QDP-125-05

04 1/4" axle
05 5/16" axle
06 3/8" axle
08 1/2" axle
10 5/8" axle
12 3/4" axle

DUAL WHEEL (DW) CASTERS

TOP PLATE/
HOLLOW KINGPIN MODELS
FREE SWIVEL • TOTAL LOCK



APPLICATIONS

- Patient Lifts
- Medical Equipment
- Computer Equipment

FEATURES

- Low profile, easy swiveling and smooth rolling.
- Durable zinc plated finish
- Non-marking TPR rubber tread
- Foot activated total lock brake
- Integrated thread guards
- Dual ball bearing raceway
- Precision Bearings in Wheels

Our Dual wheel casters provide a low profile, easy swiveling and smooth rolling.

TOP PLATE SWIVEL MODELS

Wheel Diameter (Inches)	Tread Width (Inches)	Wheel Description	Capacity (Lbs)	Load Height Inches (mm)	Swivel Radius Inches (mm)	Wheel Bearing	
2	1-21/32	Grey Rubber	200	2-29/32" (74)	2-1/8 (54)	Precision	DW-02GRP-100-SW-___
3	2	Thermoplastic Rubber	220	4-1/16" (103)	2-23/32 (69)	Precision	DW-03TPP-100-SW-___



TOP PLATE SWIVEL TOTAL LOCK MODELS

(LOCKS WHEEL AND SWIVEL)

Wheel Diameter (Inches)	Tread Width (Inches)	Wheel Description	Capacity (Lbs)	Load Height Inches (mm)	Swivel Radius Inches (mm)	Wheel Bearing	
2	1-21/32	Grey Rubber	200	2-29/32" (74)	3-3/16 (81)	Precision	DW-02GRP-100-TL-___
3	2	Thermoplastic Rubber	220	4-1/16" (103)	3-1/2 (89)	Precision	DW-03TPP-100-TL-___



HOLLOW KINGPIN SWIVEL MODELS

Wheel Diameter (Inches)	Tread Width (Inches)	Wheel Description	Capacity (Lbs)	Load Height Inches (mm)	Swivel Radius Inches (mm)	Wheel Bearing	
2	1-21/32	Grey Rubber	200	2-27/32" (72)	2-1/8 (54)	Precision	DW-02GRP-100-SW-___
3	2	Thermoplastic Rubber	220	3-15/16" (100)	2-23/32 (69)	Precision	DW-03TPP-100-SW-___



HOLLOW KINGPIN TOTAL LOCK MODELS

(LOCKS WHEEL AND SWIVEL)

Wheel Diameter (Inches)	Tread Width (Inches)	Wheel Description	Capacity (Lbs)	Load Height Inches (mm)	Swivel Radius Inches (mm)	Wheel Bearing	
2	1-21/32	Grey Rubber	200	2-27/32" (72)	3-3/16 (81)	Precision	DW-02GRP-100-TL-___
3	2	Thermoplastic Rubber	220	3-15/16" (100)	3-1/2 (89)	Precision	DW-03TPP-100-TL-___



TOP PLATE FITTING

Swivel Top Plate Pattern

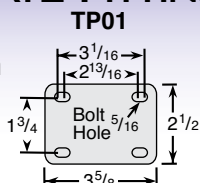

TP04

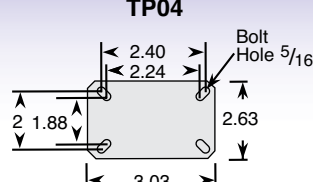

TP11

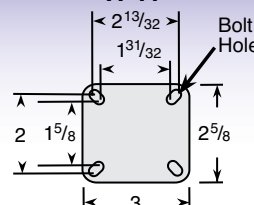

HOLLOW RIVET

Caster is provided assembled. Change HK01 code to HKU1 for unassembled. 1/2" I.D.

TWIN WHEEL (TW) CASTERS

GRIP RING & THREADED STEM MODELS
FREE SWIVEL • BRAKE



APPLICATIONS

- Medical Carts
- Furniture
- Concentrator Bases
- Utility Carts

FEATURES

- Durable Nylon Construction
- Riveted Axle
- Smooth Finish Design
- Custom colors available

Contemporary design features strong nylon construction.

GRIP RING/THREADED STEM MODELS

Wheel Diameter (Inches)	Tread Width (Inches)	Wheel Description	Capacity (Lbs)	Load Height (Inches)	Swivel Radius (Inches)	Wheel Bearing	Model Number
2	1-7/8	Nylon Black	90	2-29/64" (62)	2" (51)	Plain	TW-02NYO-200-SW-
3	2-1/4	Thermoplastic Rubber	165	3-1/4" (83)	2-1/2" (64)	Plain	TW-03TPO-200-SW-
3	2-1/4	Nylon Black	165	3-1/4" (83)	2-1/2" (64)	Plain	TW-03NYO-200-SW-
4	2-3/8	Polyurethane Black	175	4-3/8" (111)	3-5/8" (92)	Plain	TW-04PBO-200-SW-
4	2-3/8	Nylon Black	175	4-3/8" (111)	3-5/8" (92)	Plain	TW-04NYO-200-SW-
5	2-3/8	Polyurethane Black	180	5-7/16" (138)	4-1/2" (114)	Plain	TW-05PBO-200-SW-
5	2-3/8	Nylon Black	180	5-7/16" (138)	4-1/2" (114)	Plain	TW-05NYO-200-SW-



GRIP RING/THREADED STEM BRAKE MODELS

Wheel Diameter (Inches)	Tread Width (Inches)	Wheel Description	Capacity (Lbs)	Load Height (Inches)	Swivel Radius (Inches)	Wheel Bearing	Model Number
2	1-7/8	Nylon Black	90	2-29/64" (62)	2" (51)	Plain	TW-02NYO-200-TB-
3	2-1/4	Thermoplastic Rubber	165	3-1/4" (83)	2-1/2" (64)	Plain	TW-03TPO-200-TB-
3	2-1/4	Nylon Black	165	3-1/4" (83)	2-1/2" (64)	Plain	TW-03NYO-200-TB-
4	2-3/8	Polyurethane Black	175	4-3/8" (111)	3-5/8" (92)	Plain	TW-04PBO-200-TB-
4	2-3/8	Nylon Black	175	4-3/8" (111)	3-5/8" (92)	Plain	TW-04NYO-200-TB-
5	2-3/8	Polyurethane Black	180	5-7/16" (138)	4-1/2" (114)	Plain	TW-05PBO-200-TB-
5	2-3/8	Nylon Black	180	5-7/16" (138)	4-1/2" (114)	Plain	TW-05NYO-200-TB-



Top Plate models are available in some of the above sizes, please consult factory.

Specify Grip Ring Stem (GR) or Threaded Stem (TS) code, see fittings below for dimensions:

GRIP RING STEM FITTINGS

See fittings page for more options.

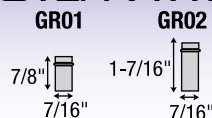

THREADED STEM FITTINGS

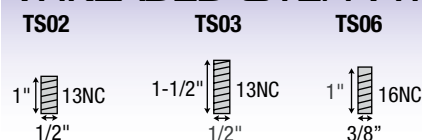

GREY TECH (GT) CASTERS

GRIP RING STEM, THREADED
STEM & SWIVEL PLATE MODELS
FREE SWIVEL • BRAKE



APPLICATIONS

- Electronic Equipment
- Medical Equipment
- Audio/Visual Equipment
- Furniture

FEATURES

- Soft 70-75/A durometer tread constructed of high-tech thermoplastic elastomer
- High load ratings
- Quite mobility
- Riveted axle for positive wheel retention

Soft tread twin wheel caster for quiet mobility

GRIP RING/THREADED STEM MODELS

Wheel Diameter Inches (mm)	Tread Width (Inches)	Wheel Description	Capacity (Lbs)	Load Height Inches (mm)	Swivel Radius Inches (mm)	Wheel Bearing	Model Number
2 (50)	2-1/4	Thermoplastic Rubber	75	2-1/4" (57)	1-13/16" (46)	Plain	GT-02TPO-200-SW-___
3 (75)	2-1/4	Thermoplastic Rubber	165	3-1/4" (83)	2-1/2" (64)	Plain	GT-03TPO-200-SW-___
4 (100)	2-1/4	Thermoplastic Rubber	225	4-3/8" (111)	3-5/8" (92)	Plain	GT-04TPO-200-SW-___
5 (125)	2-1/4	Thermoplastic Rubber	225	5-7/16" (138)	4-1/2" (114)	Plain	GT-05TPO-200-SW-___

GRIP RING/THREADED STEM BRAKE MODELS

2 (50)	2-1/4	Thermoplastic Rubber	75	2-1/4" (57)	2-3/8" (60)	Plain	GT-02TPO-200-TB-___
3 (75)	2-1/4	Thermoplastic Rubber	165	3-1/4" (83)	3-3/16" (81)	Plain	GT-03TPO-200-TB-___
4 (100)	2-1/4	Thermoplastic Rubber	225	4-3/8" (111)	4-1/2" (114)	Plain	GT-04TPO-200-TB-___
5 (125)	2-1/4	Thermoplastic Rubber	225	5-7/16" (138)	5-1/8" (130)	Plain	GT-05TPO-200-TB-___

TOP PLATE MODELS

2 (50)	2-1/4	Thermoplastic Rubber	75	2-3/8" (60)	1-13/16" (46)	Plain	GT-02TPO-200-SW-___
3 (75)	2-1/4	Thermoplastic Rubber	165	3-1/2" (89)	2-1/2" (64)	Plain	GT-03TPO-200-SW-___
4 (100)	2-1/4	Thermoplastic Rubber	225	4-5/8" (117)	3-5/8" (92)	Plain	GT-04TPO-200-SW-___
5 (125)	2-1/4	Thermoplastic Rubber	225	5-5/8" (143)	4-1/2" (114)	Plain	GT-05TPO-200-SW-___

TOP PLATE BRAKE MODELS

2 (50)	2-1/4	Thermoplastic Rubber	75	2-3/8" (60)	2-3/8" (60)	Plain	GT-02TPO-200-TB-___
3 (75)	2-1/4	Thermoplastic Rubber	165	3-1/2" (89)	3-3/16" (81)	Plain	GT-03TPO-200-TB-___
4 (100)	2-1/4	Thermoplastic Rubber	225	4-5/8" (117)	4-1/2" (114)	Plain	GT-04TPO-200-TB-___
5 (125)	2-1/4	Thermoplastic Rubber	225	5-5/8" (143)	5-1/8" (130)	Plain	GT-05TPO-200-TB-___



Specify fitting code, see fittings below for dimensions:

GRIP RING STEM FITTINGS

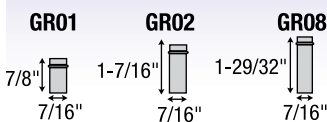

THREADED STEM FITTINGS



TOP PLATES

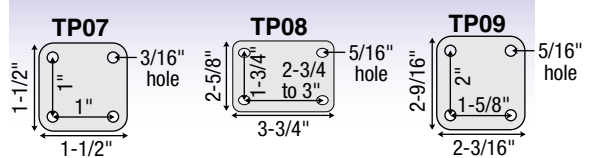

See fittings page for more options.

MEDIMASTER (MM)

THREADED STEM MODELS

FREE SWIVEL • BRAKE



APPLICATIONS

- Nursing Home Beds
- Medical Carts
- Electronic Equipment
- Patient Aids

FEATURES

- Two Precision ball bearings located in the swivel raceway
- Wheels have precision ball bearings for easy rollability
- Our design protects axle/bearing areas from hair/water
- Wheels can be removed for easy cleaning

The MediMaster body and wheel cores are made of Nylon 6 material for added strength and durability. Our wheel treads are made of Thermoplastic polyurethane.



FREE SWIVEL MODELS

Wheel Diameter (Inches)	Tread Width Inches (mm)	Wheel Description	Capacity (Lbs)	Load Height Inches (mm)	Swivel Lead Inches (mm)	Wheel Bearing	Model Number
4	2-13/16" (72)	Polyurethane Gray	220	4-23/32" (120)	3-5/16" (84)	Precision Ball	MM-04PYP-281-SW-_____



BRAKE MODELS

Wheel Diameter (Inches)	Tread Width Inches (mm)	Wheel Description	Capacity (Lbs)	Load Height Inches (mm)	Swivel Lead Inches/mm)	Wheel Bearing	Model Number
4	2-13/16" (72)	Polyurethane Gray	220	4-23/32" (120)	3-35/64" (90)	Precision Ball	MM-04PYP-281-TB-_____

THREADED STEM FITTINGS

See fittings page for more options.

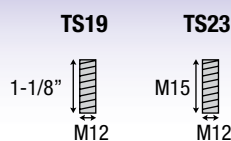

Specify Threaded Stem (TS) code, see fittings below for dimensions:

NEOTEQ DUAL (DN) COMFORT ROLL

TOP PLATE MODELS
FREE SWIVEL • BRAKE



APPLICATIONS

- Laboratory Equipment
- IV Stands
- Mobile Computer Stands
- Medical Equipment

FEATURES

- Bright Chrome Finish
- Dual wheels maneuver easily
- Matching Chrome Thread Guards for wheels
- Non-Marking Soft-Neoprene Rubber wheels
- Dual Ball Swivel Raceways for added strength
- Precision ball bearings in wheels for easier rollability
- Upper dustcap to prevent dirt and dust build-up

Dual Wheel Chrome NeoTeq series are designed to provide your equipment with a smooth and quiet roll with easy turning and maneuverability.

SWIVEL TOP PLATE MODELS



Wheel Diameter (Inches)	Tread Width Inches (mjm)	Wheel Description	Capacity (Lbs)	Load Height Inches (mm)	Swivel Radius Inches (mm)	Wheel Bearing	Model Number
2	1" (25)	Neoprene Rubber	250	3-3/8" (86)	2-3/8 (60)	Precision Ball	DN-02NRP-100-SW-TP01
2-1/2	1" (25)	Neoprene Rubber	300	3-7/8 (98)	2-1/2" (63)	Precision Ball	DN-25NRP-100-SW-TP01

RIGID TOP PLATE MODELS



Wheel Diameter (Inches)	Tread Width Inches (mjm)	Wheel Description	Capacity (Lbs)	Load Height Inches (mm)	Swivel Radius Inches (mm)	Wheel Bearing	Model Number
2	1" (25)	Neoprene Rubber	250	3-3/8" (86)	N/A	Precision Ball	DN-02NRP-100-RG-TP01
2-1/2	1" (25)	Neoprene Rubber	300	3-7/8 (98)	N/A	Precision Ball	DN-25NRP-100-RG-TP01

HOLLOW KINGPIN MODELS

Wheel Diameter (Inches)	Tread Width Inches (mjm)	Wheel Description	Capacity (Lbs)	Load Height Inches (mm)	Swivel Radius Inches (mm)	Wheel Bearing	Model Number
2	1" (25)	Neoprene Rubber	250	3-1/4" (83)	2-3/8 (60)	Precision Ball	DN-02NRP-100-SW-HK01
2-1/2	1" (25)	Neoprene Rubber	300	3-3/4 (95)	2-1/2" (63)	Precision Ball	DN-25NRP-100-SW-HK01

FITTINGS

See fittings page for more options.

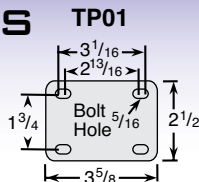

HOLLOW RIVET

Caster is provided assembled. Change HK01 code to HKU1 for unassembled. 1/2" I.D.

TWIN-MED (TM)

THREADED STEM MODELS

FREE SWIVEL • BRAKE



- APPLICATIONS**
- Nursing Home Beds
 - Medical Carts
 - Diagnostic Equipment
 - Electronic Equipment
 - Patient Aids
 - Patient Lifts

- FEATURES**
- Double ball bearing located in the swivel raceway
 - Wheels have easy rollability
 - Our design protects axle/bearing areas from hair/water
 - Total Lock models lock both the wheel and swivel
 - Directional Lock (locks swivel) models are available. Please consult factory.

Special colors available. Consult factory.

New Flexthane softer urethane tread available. To order change PYP to FYP in wheel code (Example: TM-03FYP-281-SW-TS02).



FREE SWIVEL MODELS

Wheel Diameter (Inches)	Tread Width Inches (mm)	Wheel Description	Capacity (Lbs)	Load Height Inches (mm)	Swivel Radius Inches (mm)	Wheel Bearing	Model Number
3	2-5/16" (59)	Polyurethane Gray	165	3-3/4" (95)	2-7/16" (65)	Plain	TM-03PYO-281-SW-____
3	2-5/16" (59)	Polyurethane Gray	165	3-3/4" (95)	2-7/16" (65)	Precision	TM-03PYP-281-SW-____
4	2-39/64" (66)	Polyurethane Gray	220	5" (127)	3-1/8" (79)	Plain	TM-04PYO-281-SW-____
4	2-39/64" (66)	Polyurethane Gray	220	5" (127)	3-1/8" (79)	Precision	TM-04PYP-281-SW-____
5	3" (76)	Polyurethane Gray	246	6" (152)	4" (102)	Precision	TM-05PYP-281-SW-____

Total Lock (Grey Pedal)



TOTAL LOCK MODELS (LOCKS WHEEL AND SWIVEL)

Wheel Diameter (Inches)	Tread Width Inches (mm)	Wheel Description	Capacity (Lbs)	Load Height Inches (mm)	Swivel Radius Inches (mm)	Wheel Bearing	Model Number
3	2-5/16" (59)	Polyurethane Gray	165	3-3/4" (95)	2-3/4" (70)	Plain	TM-03PYO-281-TL-____
3	2-5/16" (59)	Polyurethane Gray	165	3-3/4" (95)	2-3/4" (70)	Precision	TM-03PYP-281-TL-____
4	2-39/64" (66)	Polyurethane Gray	220	5" (127)	3-5/8" (92)	Plain	TM-04PYO-281-TL-____
4	2-39/64" (66)	Polyurethane Gray	220	5" (127)	3-5/8" (92)	Precision	TM-04PYP-281-TL-____
5	3" (76)	Polyurethane Gray	246	6" (152)	4-1/4" (108)	Precision	TM-05PYP-281-TL-____

THREADED STEM FITTINGS

See fittings page for more options.

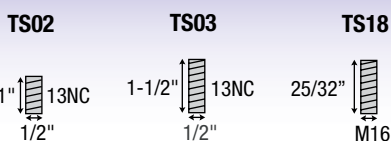

Specify Threaded Stem (TS) code, see fittings below for dimensions:

TWIN-MED (TM)

TOP PLATE MODELS FREE SWIVEL • BRAKE



- APPLICATIONS**
- Nursing Home Beds
 - Medical Carts
 - Diagnostic Equipment
 - Electronic Equipment
 - Patient Aids
 - Patient Lifts

- FEATURES**
- Double ball bearing located in the swivel raceway
 - Wheels have easy rollability
 - Our design protects axle/bearing areas from hair/water
 - Total Lock models lock both the wheel and swivel
 - Directional Lock (locks swivel) models are available on all precision bearing models.

Special colors available. Consult factory.

New Flexthane softer urethane tread available. To order change PYP to FYP in wheel code (Example: TM-03FYP-281-SW-TS02).



FREE SWIVEL MODELS

Wheel Diameter (Inches)	Tread Width Inches (mm)	Wheel Description	Capacity (Lbs)	Load Height Inches (mm)	Swivel Radius Inches (mm)	Wheel Bearing	Model Number
3	2-5/16 (59)	Polyurethane Gray	165	4-1/8" (105)	2-5/16" (59)	Plain	TM-03PYO-281-SW-TP01
3	2-5/16 (59)	Polyurethane Gray	165	4-1/8" (105)	2-5/16" (59)	Precision	TM-03PYP-281-SW-TP01
4	2-39/64" (66)	Polyurethane Gray	220	5-3/8" (137)	3-1/8" (79)	Plain	TM-04PYO-281-SW-TP01
4	2-39/64" (66)	Polyurethane Gray	220	5-3/8" (137)	3-1/8" (79)	Precision	TM-04PYP-281-SW-TP01
5	3" (76)	Polyurethane Gray	246	6-3/8" (162)	4" (102)	Precision	TM-05PYP-281-SW-TP01



TOTAL LOCK MODELS (LOCKS WHEEL AND SWIVEL)

Wheel Diameter (Inches)	Tread Width Inches (mm)	Wheel Description	Capacity (Lbs)	Load Height Inches (mm)	Swivel Radius Inches (mm)	Wheel Bearing	Model Number
3	2-5/16 (59)	Polyurethane Gray	165	4-1/8" (105)	2-3/4" (70)	Plain	TM-03PYO-281-TL-TP01
3	2-5/16 (59)	Polyurethane Gray	165	4-1/8" (105)	2-3/4" (70)	Precision*	TM-03PYP-281-TL-TP01
4	2-39/64" (66)	Polyurethane Gray	220	5-3/8" (137)	3-5/8" (92)	Plain	TM-04PYO-281-TL-TP01
4	2-39/64" (66)	Polyurethane Gray	220	5-3/8" (137)	3-5/8" (92)	Precision*	TM-04PYP-281-TL-TP01
5	3" (76)	Polyurethane Gray	246	6-3/8" (162)	4-1/4" (108)	Precision*	TM-05PYP-281-TL-TP01

TOP PLATE FITTINGS

See fittings page for more options.

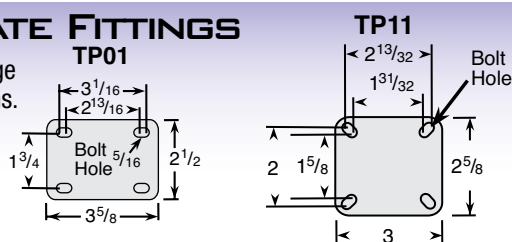

*Change "TL" to "DL" for Direction Lock models. Available on all precision bearing models. TM-04PYP-281-DL-TP01 shown.

MULTI-FUNCTION (MF)

FREE SWIVEL • MULTI-FUNCTION BRAKE

NEW



APPLICATIONS

- Mobile computer stands
- Diagnostic equipment
- Crash carts
- Portable CT units

FEATURES

- Double ball raceways
- zinc plated fittings
- Powder metal wheel bearings
- Multifunction Brake Models: Press large outer pedal to lock direction (locks swivel). Press both pedals to lock both wheel and swivel (Total Lock)

6" models coming soon!

MULTI-FUNCTION BRAKE

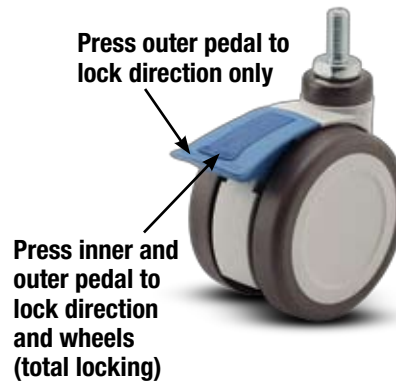

FREE SWIVEL MODELS

Wheel Diameter (Inches)	Tread Width (Inches)	Wheel Description	Capacity (Lbs)	Load Height Inches (mm)	Swivel Radius (Inches/mm)	Wheel Bearing	Model Number
4	2-5/8	Polyurethane	330	5" (127)	3-1/8" (80)	Plain	MF-04PYN-281-SW
5	2-5/8	Polyurethane	400	6" (152)	3-3/4" (95)	Plain	MF-05PYN-281-SW



MULTIFUNCTION BRAKE MODELS

Wheel Diameter (Inches)	Tread Width (Inches)	Wheel Description	Capacity (Lbs)	Load Height Inches (mm)	Swivel Radius (Inches/mm)	Wheel Bearing	Model Number
4	2-5/8	Polyurethane	330	5" (127)	3-7/16" (100)	Plain	MF-04PYN-281-DT
5	2-5/8	Polyurethane	400	6" (152)	4-9/16" (116)	Plain	MF-05PYN-281-DT



FITTINGS

Top Plate

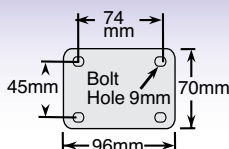

Threaded Stem

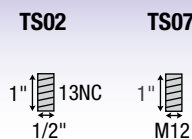

KICK STOP (KS)

FREE SWIVEL • TOTAL LOCK • DIRECTION LOCK



APPLICATIONS

- Medical and diagnostic equipment
- Computer equipment
- Electronic equipment
- High-tech products

FEATURES

- Foot brake easily engaged; mechanically locks both swivel and wheel rotation
- Strong pressure diecast metal construction for lasting performance and maximum reliability
- Precision axle built to exacting tolerances for smooth operation and extended service life
- Aluminum die cast body and wheel centers
- Standard finish is white or ball burnished and lacquered

Medcaster Kick Stop casters give you the benefits of twin-wheel design with the convenience of a foot brake to lock both wheel and swivel simultaneously. This modern design features two wheels that spin independently of each other for easier turning in tight spots and for improved stability. Custom colors are available to match your equipment (Consult factory). Kick Stop casters are covered by world-wide patents and designs.

FREE SWIVEL MODELS

Wheel Diameter (Inches)	Tread Width (Inches)	Wheel Description	Capacity (lbs)	Load Height Inches (mm)	Swivel Lead (Inches/mm)	Wheel Bearing	Model Number
3	19/32	Polyurethane Gray	132	3-37/64" (91)	7/8" (22)	Delrin	KS-03PYD-150-SW-____
3	19/32	Polyurethane Black	132	3-37/64" (91)	7/8" (22)	Delrin	KS-03PBD-150-SW-____
4	19/32	Anti-Static Black Rubber	132	4-3/4" (120)	1-9/64" (29)	Roller	KS-04ARR-150-SW-____
4	19/32	Rubber Gray	132	4-3/4" (120)	1-9/64" (29)	Roller	KS-04RPR-150-SW-____
4	19/32	Rubber Gray	132	4-3/4" (120)	1-9/64" (29)	Delrin	KS-04RPD-150-SW-____
5	5/8	Anti-Static Black Rubber	175	5-13/16" (148)	1-35/64" (39)	Roller	KS-05ARR-150-SW-____
5	5/8	Rubber Gray	175	5-13/16" (148)	1-35/64" (39)	Roller	KS-05RPR-150-SW-____
5	5/8	Rubber Gray	175	5-13/16" (148)	1-35/64" (39)	Delrin	KS-05RPD-150-SW-____

TOTAL LOCK MODELS

3	19/32	Polyurethane Gray	132	3-37/64" (91)	7/8" (22)	Delrin	KS-03PYD-150-TL-____
3	19/32	Polyurethane Black	132	3-37/64" (91)	7/8" (22)	Delrin	KS-03PBD-150-TL-____
4	19/32	Anti-Static Black Rubber	132	4-3/4" (120)	1-9/64" (29)	Roller	KS-04ARR-150-TL-____
4	19/32	Rubber Gray	132	4-3/4" (120)	1-9/64" (29)	Roller	KS-04RPR-150-TL-____
4	19/32	Rubber Gray	132	4-3/4" (120)	1-9/64" (29)	Delrin	KS-04RPD-150-TL-____
5	5/8	Anti-Static Black Rubber	175	5-13/16" (148)	1-35/64" (39)	Roller	KS-05ARR-150-TL-____
5	5/8	Rubber Gray	175	5-13/16" (148)	1-35/64" (39)	Roller	KS-05RPR-150-TL-____
5	5/8	Rubber Gray	175	5-13/16" (148)	1-35/64" (39)	Delrin	KS-05RPD-150-TL-____

THREADED STEM FITTINGS

See fittings page for more options.

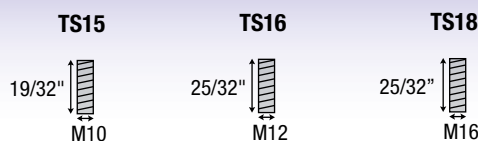

Specify Threaded Stem (TS) code, see fittings below for dimensions:

STREAMLINE (SL)

TOP PLATE/GRIP RING/
FREE SWIVEL • TOTAL LOCK

NEW



APPLICATIONS

- Laboratory Equipment
- Mobile Computer Stands
- Medical Equipment
- Diagnostic equipment
- Hospital beds

4" and 6" sizes available, consult factory.

FEATURES

- Dual total lock brake design provides you an on and off option.
- Total locking brake locks both the swivel and wheel
- Double ball swivel raceways provides smooth operation and increased capacity
- Plastic shroud can be molded in a variety of colors to match your equipment



Streamline casters feature dual total lock brake design along with color options for plastic shroud. Wheels feature precision bearings.

SWIVEL TOP PLATE MODELS

Wheel Diameter (Inches)	Tread Width (Inches)	Wheel Description	Capacity (Lbs)	Load Height Inches (mm)	Swivel Radius Inches (mm)	Wheel Bearing	Model Number
5	1-1/4	Rubber on Aluminum	325	6-1/2" (165.5)	4-5/16" (110)	Precision Ball	SL-05RMP-125-SW-___
5	1-1/4	Polyurethane on Plastic	325	6-1/2" (165.5)	4-5/16" (110)	Precision Ball	SL-05PYP-125-SW-___

SWIVEL TOP PLATE MODELS

Wheel Diameter (Inches)	Tread Width (Inches)	Wheel Description	Capacity (Lbs)	Load Height Inches (mm)	Swivel Radius Inches (mm)	Wheel Bearing	Model Number
5	1-1/4	Rubber on Aluminum	325	6-1/2" (165.5)	4-5/16" (110)	Precision Ball	SL-05RMP-125-TL-___
5	1-1/4	Polyurethane on Plastic	325	6-1/2" (165.5)	4-5/16" (110)	Precision Ball	SL-05PYP-125-TL-___

Specify TP01 for top plate, TS02 for threaded stem, or GR09 for grip ring stem models. See fittings at left for dimensions.

FITTINGS

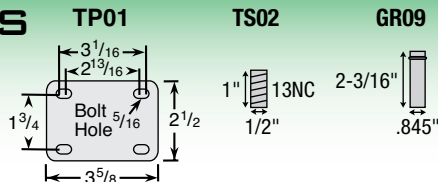

SOLUS TECH (ST)

FREE SWIVEL • TOTAL LOCK • DIRECTION LOCK



APPLICATIONS

- Medical and diagnostic equipment
- Computer equipment
- Electronic equipment
- High-tech products

Special colors available. Consult factory.

FEATURES

- Foot brake easily engaged; mechanically locks both swivel and wheel rotation
- Aluminum shell hides nuts and bolts
- Quiet operation
- Precision axle built to exacting tolerance for smooth operation and extended life
- Precision bearings reduce maintenance and improve maneuverability
- Choose from a wide variety of colors--minimum quantities required
- Polyurethane tires can be molded in a variety of colors, hardness
- Caster construction for non-magnetic characteristics
- Antistatic rubber, nylon, or polyurethane wheels

The unique shell design of the Solus Tech helps keep dirt out of the internal mechanism of the caster for a long service life. For routine maintenance, the outer shell can be removed from the caster for access to the internal braking mechanism.

FREE SWIVEL MODELS

Wheel Diameter (Inches)	Tread Width (Inches)	Wheel Description	Capacity (Lbs)	Load Height Inches (mm)	Swivel Lead Inches (mm)	Wheel Bearing	Model Number
4	1-15/32	Polyurethane Gray	175	5-19/32" (142)	3-15/16" (100)	Precision Ball	ST-04PYP-150-SW-TS15
5	1-15/32	Polyurethane Gray	220	6-13/16" (173)	4-15/16" (125)	Precision Ball	ST-05PYP-150-SW-TS16

TOTAL LOCK MODELS

4	1-15/32	Polyurethane Gray	175	5-19/32" (142)	3-15/16" (100)	Precision Ball	ST-04PYP-150-TL-TS15
5	1-15/32	Polyurethane Gray	220	6-13/16" (173)	4-15/16" (125)	Precision Ball	ST-05PYP-150-TL-TS16

DIRECTION LOCK MODELS

4	1-15/32	Polyurethane Gray	175	5-19/32" (142)	3-15/16" (100)	Precision Ball	ST-04PYP-150-DL-TS15
5	1-15/32	Polyurethane Gray	220	6-13/16" (173)	4-15/16" (125)	Precision Ball	ST-05PYP-150-DL-TS16

THREADED STEM FITTINGS

Easy to install stem. See fittings page for more options.

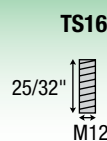
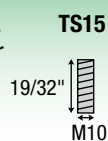

NEOTEQ (CN) COMFORT ROLL

TOP PLATE/GRIP RING/THREADED/
HOLLOW KINGPIN

FREE SWIVEL • TOTAL LOCK



APPLICATIONS

- Laboratory Equipment
- IV Stands
- Mobile Computer Stands
- Medical Equipment

Grey Rubber wheels available, consult factory.

FEATURES

- Bright Chrome Finish
- Matching Chrome Thread Guards for wheels
- Non-Marking Soft-Neoprene Rubber wheels
- Dual Ball Swivel Raceways for added strength
- **Total Lock Brake** models lock both swivel and wheel
- Precision ball bearings in wheels for easier rollability
- **NEW!** Durable coated metal dust shield

NEOTEQ FAMILY IS GROWING



Our Chrome NeoTeq series are designed to provide your equipment with a smooth and quiet roll.

SWIVEL TOP PLATE MODELS

Wheel Diameter (Inches)	Tread Width (Inches)	Wheel Description	Capacity (Lbs)	Load Height Inches (mm)	Swivel Radius Inches (mm)	Wheel Bearing	Model Number
2	1	Neoprene Rubber	125	2-15/16" (75)	2" (51)	Precision Ball	CN-02NRP-100-SW-
2-1/2	1	Neoprene Rubber	165	3-1/2" (89)	2-1/2" (54)	Precision Ball	CN-25NRP-100-SW-
3	1	Neoprene Rubber	175	4-5/32" (105)	2-13/16" (71)	Precision Ball	CN-03NRP-100-SW-



SWIVEL PLATE TOTAL LOCK MODELS

(LOCKS WHEEL AND SWIVEL)

Wheel Diameter (Inches)	Tread Width (Inches)	Wheel Description	Capacity (Lbs)	Load Height Inches (mm)	Swivel Radius Inches (mm)	Wheel Bearing	Model Number
2	1	Neoprene Rubber	125	2-15/16" (75)	2" (51)	Precision Ball	CN-02NRP-100-TL-
2-1/2	1	Neoprene Rubber	165	3-1/2" (89)	2-11/16" (56)	Precision Ball	CN-25NRP-100-TL-
3	1	Neoprene Rubber	175	4-5/32" (105)	2-13/16" (71)	Precision Ball	CN-03NRP-100-TL-



Grey rubber wheels available, consult factory.



FITTINGS

2-1/2" and 3" only for TP01.

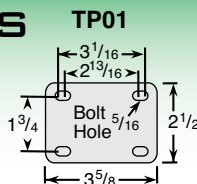

TP02

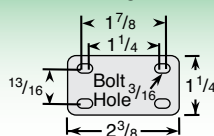

TP02 Swivel Top Plate Fitting Patterns

2" diameter caster: 13/16" x 1-1/4" through 1-7/8" slotted
3" diameter caster: 13/16" x 1-7/8" (not slotted)

NEOTEQ (CN) COMFORT ROLL

GRIP RING STEM MODELS

Wheel Diameter (Inches)	Tread Width (Inches)	Wheel Description	Capacity (Lbs)	Load Height Inches (mm)	Swivel Radius Inches (mm)	Wheel Bearing	Model Number
2	1	Neoprene Rubber	125	2-11/16" (68)	2" (51)	Precision Ball	CN-02NRP-100-SW-GR01
2-1/2	1	Neoprene Rubber	165	3-3/8" (86)	2-1/2" (54)	Precision Ball	CN-25NRP-100-SW-GR01
3	1	Neoprene Rubber	175	4" (102)	2-13/16" (71)	Precision Ball	CN-03NRP-100-SW-GR01



GRIP RING STEM TOTAL LOCK MODELS

(LOCKS WHEEL AND SWIVEL)

2	1	Neoprene Rubber	125	2-11/16" (68)	2" (51)	Precision Ball	CN-02NRP-100-TL-GR01
2-1/2	1	Neoprene Rubber	165	3-3/8" (86)	2-11/16" (56)	Precision Ball	CN-25NRP-100-TL-GR01
3	1	Neoprene Rubber	175	4" (102)	2-13/16" (71)	Precision Ball	CN-03NRP-100-TL-GR01



THREADED STEM MODELS

Wheel Diameter (Inches)	Tread Width (Inches)	Wheel Description	Capacity (Lbs)	Load Height Inches (mm)	Swivel Radius Inches (mm)	Wheel Bearing	Model Number
2	1	Neoprene Rubber	125	2-11/16" (68)	2" (51)	Precision Ball	CN-02NRP-100-SW-TS06
2-1/2	1	Neoprene Rubber	165	3-3/8" (86)	2-1/2" (54)	Precision Ball	CN-25NRP-100-SW-TS06
3	1	Neoprene Rubber	175	4" (102)	2-13/16" (71)	Precision Ball	CN-03NRP-100-SW-TS06



THREADED STEM TOTAL LOCK MODELS

(LOCKS WHEEL AND SWIVEL)

2-1/2	1	Neoprene Rubber	165	3-3/8" (86)	2-11/16" (56)	Precision Ball	CN-25NRP-100-TL-TS06
3	1	Neoprene Rubber	175	4" (102)	2-13/16" (71)	Precision Ball	CN-03NRP-100-TL-TS06



HOLLOW KINGPIN MODELS

Wheel Diameter (Inches)	Tread Width (Inches)	Wheel Description	Capacity (Lbs)	Load Height Inches (mm)	Swivel Radius Inches (mm)	Wheel Bearing	Model Number
2	1	Neoprene Rubber	125	2-11/16" (68)	2" (51)	Precision Ball	CN-02NRP-100-SW-HK04
2-1/2	1	Neoprene Rubber	165	3-3/8" (86)	2-1/2" (54)	Precision Ball	CN-25NRP-100-SW-HK04
3	1	Neoprene Rubber	175	4" (102)	2-13/16" (71)	Precision Ball	CN-03NRP-100-SW-HK04



Recommended for use with 3/8" diameter fittings.

HOLLOW KINGPIN TOTAL LOCK MODELS

(LOCKS WHEEL AND SWIVEL)

2	1	Neoprene Rubber	125	2-11/16" (68)	2" (51)	Precision Ball	CN-02NRP-100-TL-HK04
2-1/2	1	Neoprene Rubber	165	3-3/8" (86)	2-11/16" (56)	Precision Ball	CN-25NRP-100-TL-HK04
3	1	Neoprene Rubber	175	4" (102)	2-13/16" (71)	Precision Ball	CN-03NRP-100-TL-HK04



Recommended for use with 3/8" diameter fittings.

Grey rubber wheels available, consult factory.

GRIP RING STEM

GR01



GR02

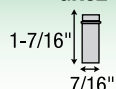

THREADED STEM

TS06

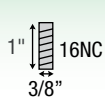

HOLLOW RIVET

Recommended for use with 3/8" diameter fittings.

See fitting chart for additional options.

RAZER (RZ)

TOP PLATE MODELS

FREE SWIVEL • TOTAL LOCK



NEW Grey Rubber Wheel (GRP)

Grey TPR Wheel Model (TPP)

APPLICATIONS

- Laundry Hampers
- Mobile Hospital Furniture
- Bassinets
- Hospital
- Chairs/Recliners
- Home Healthcare Beds

FEATURES

- Economical
- Polished chrome finish
- Double ball swivel raceways for added strength
- **Total Lock Brake** models lock both swivel and wheel
- Full thread guards for added protection (except 2" diameter models)
- Ball bearings included on 3" to 5" wheel diameter models. Plain bearing on 2" model

SWIVEL TOP PLATE MODELS

Wheel Diameter (Inches)	Tread Width (Inches)	Wheel Description	Capacity (Lbs)	Load Height Inches (mm)	Swivel Radius Inches (mm)	Wheel Bearing	Model Number
2	3/4"	Grey Rubber	110	2-13/16" (71)	1.95" (50)	Plain	RZ-02GRN-070-SW-TP06
2	3/4"	Grey TPR	110	2-13/16" (71)	1.95" (50)	Plain	RZ-02TPN-070-SW-TP06
3	7/8"	Grey Rubber	140	4.07" (103)	2.85" (73)	Ball Bearing	RZ-03GRP-090-SW-TP05
3	7/8"	Grey TPR	140	4.07" (103)	2.85" (73)	Ball Bearing	RZ-03TPP-090-SW-TP05
4	7/8"	Grey Rubber	160	4.92" (125)	3.35" (85)	Ball Bearing	RZ-04GRP-090-SW-TP05
4	7/8"	Grey TPR	160	4.92" (125)	3.35" (85)	Ball Bearing	RZ-04TPP-090-SW-TP05
5	7/8"	Grey Rubber	165	6.04" (153)	3.84" (98)	Ball Bearing	RZ-05GRP-090-SW-TP05
5	7/8"	Grey TPR	165	6.04" (153)	3.84" (98)	Ball Bearing	RZ-05TPP-090-SW-TP05



SWIVEL TOP PLATE TOTAL LOCK MODELS

(LOCKS WHEEL AND SWIVEL)

Wheel Diameter (Inches)	Tread Width (Inches)	Wheel Description	Capacity (Lbs)	Load Height Inches (mm)	Swivel Radius Inches (mm)	Wheel Bearing	Model Number
2	3/4"	Grey Rubber	110	2-13/16" (71)	3.23" (82)	Plain	RZ-02GRN-070-TL-TP06
2	3/4"	Grey TPR	110	2-13/16" (71)	3.23" (82)	Plain	RZ-02TPN-070-TL-TP06
3	7/8"	Grey Rubber	140	4.07" (103)	3.90" (104)	Ball Bearing	RZ-03GRP-090-TL-TP05
3	7/8"	Grey TPR	140	4.07" (103)	3.90" (104)	Ball Bearing	RZ-03TPP-090-TL-TP05
4	7/8"	Grey Rubber	160	4.92" (125)	4.19" (107)	Ball Bearing	RZ-04GRP-090-TL-TP05
4	7/8"	Grey TPR	160	4.92" (125)	4.19" (107)	Ball Bearing	RZ-04TPP-090-TL-TP05
5	7/8"	Grey Rubber	165	6.04" (153)	4.19" (107)	Ball Bearing	RZ-05GRP-090-TL-TP05
5	7/8"	Grey TPR	165	6.04" (153)	4.19" (107)	Ball Bearing	RZ-05TPP-090-TL-TP05



TOP PLATE FITTING

Swivel Top Plate Pattern

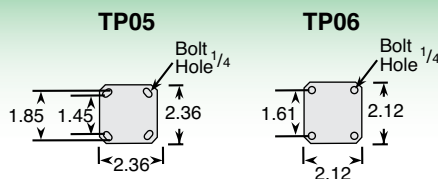

RAZER (RZ)

HOLLOW KINGPIN MODELS

FREE SWIVEL • TOTAL LOCK



NEW Grey Rubber Wheel (GRP)

Grey TPR Wheel Model (TPP)

APPLICATIONS

- Laundry Hampers
- Mobile Hospital Furniture
- Bassinets
- Hospital
- Chairs/ Recliners
- Home Healthcare Beds

FEATURES

- Economical
- Polished chrome finish
- Double ball swivel raceways for added strength
- **Total Lock Brake** models lock both swivel and wheel
- Full thread guards for added protection (except 2" diameter models)
- Ball bearings included on 3" to 5" wheel diameter models. Plain bearing on 2" model

HOLLOW KINGPIN MODELS

Wheel Diameter (Inches)	Tread Width (Inches)	Wheel Description	Capacity (Lbs)	Load Height Inches (mm)	Swivel Radius Inches (mm)	Wheel Bearing	Model Number
2	3/4"	Grey Rubber	110	2.75" (70)	1.95" (50)	Plain	RZ-02GRN-070-SW-HK04
2	3/4"	Grey TPR	110	2.75" (70)	1.95" (50)	Plain	RZ-02TPN-070-SW-HK04
3	7/8"	Grey Rubber	140	3.98" (101)	2.85" (73)	Ball Bearing	RZ-03GRP-090-SW-HK04
3	7/8"	Grey TPR	140	3.98" (101)	2.85" (73)	Ball Bearing	RZ-03TPP-090-SW-HK04
4	7/8"	Grey Rubber	160	4.84" (123)	3.35" (85)	Ball Bearing	RZ-04GRP-090-SW-HK04
4	7/8"	Grey TPR	160	4.84" (123)	3.35" (85)	Ball Bearing	RZ-04TPP-090-SW-HK04
5	7/8"	Grey Rubber	165	5.95" (151)	3.84" (98)	Ball Bearing	RZ-05GRP-090-SW-HK04
5	7/8"	Grey TPR	165	5.95" (151)	3.84" (98)	Ball Bearing	RZ-05TPP-090-SW-HK04



HOLLOW KINGPIN TOTAL LOCK MODELS

(LOCKS WHEEL AND SWIVEL)

Wheel Diameter (Inches)	Tread Width (Inches)	Wheel Description	Capacity (Lbs)	Load Height Inches (mm)	Swivel Radius Inches (mm)	Wheel Bearing	Model Number
2	3/4"	Grey Rubber	110	2.75" (70)	3.23" (82)	Plain	RZ-02GRN-070-TL-HK04
2	3/4"	Grey TPR	110	2.75" (70)	3.23" (82)	Plain	RZ-02TPN-070-TL-HK04
3	7/8"	Grey Rubber	140	3.98" (101)	3.90" (104)	Ball Bearing	RZ-03GRP-090-TL-HK04
3	7/8"	Grey TPR	140	3.98" (101)	3.90" (104)	Ball Bearing	RZ-03TPP-090-TL-HK04
4	7/8"	Grey Rubber	160	4.84" (123)	4.19" (107)	Ball Bearing	RZ-04GRP-090-TL-HK04
4	7/8"	Grey TPR	160	4.84" (123)	4.19" (107)	Ball Bearing	RZ-04TPP-090-TL-HK04
5	7/8"	Grey Rubber	165	5.95" (151)	4.19" (107)	Ball Bearing	RZ-05GRP-090-TL-HK04
5	7/8"	Grey TPR	165	5.95" (151)	4.19" (107)	Ball Bearing	RZ-05TPP-090-TL-HK04



HOLLOW RIVET

Recommended for use with 3/8" and M10 diameter fittings. Caster comes assembled.

RAZER (RZ)

GRIP RING STEM MODELS

FREE SWIVEL • TOTAL LOCK

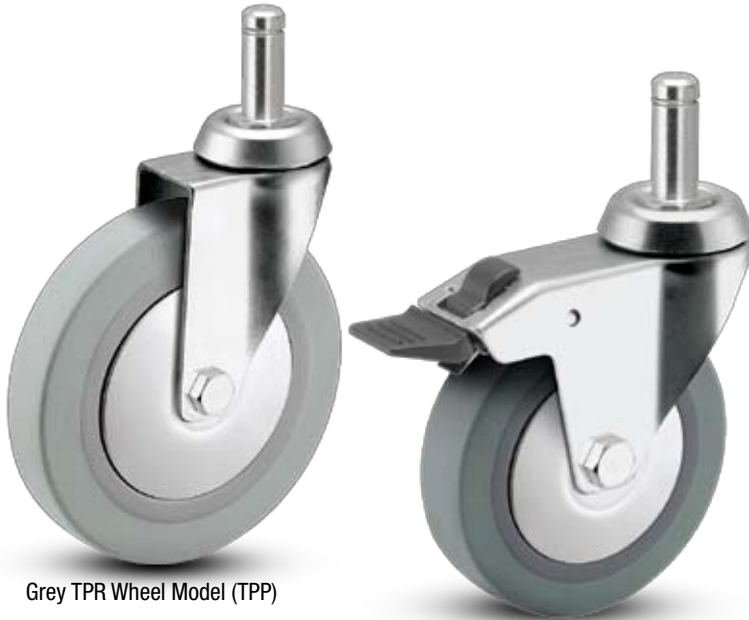

Grey TPR Wheel Model (TPP)

NEW Grey Rubber Wheel (GRP)

APPLICATIONS

- Laundry Hampers
- Mobile Hospital Furniture
- Bassinets
- Hospital Chairs/Recliners
- Home Healthcare Beds

FEATURES

- Economical
- Polished chrome finish
- Double ball swivel raceways for added strength
- **Total Lock Brake** models lock both swivel and wheel
- Full thread guards for added protection (except 2" diameter models)
- Ball bearings included on 3" to 5" wheel diameter models. Plain bearing on 2" model

GRIP RING STEM MODELS

Wheel Diameter (Inches)	Tread Width (Inches)	Wheel Description	Capacity (Lbs)	Load Height Inches (mm)	Swivel Radius Inches (mm)	Wheel Bearing	Model Number
2	3/4"	Grey Rubber	110	2.75" (70)	1.95" (50)	Plain	RZ-02GRN-070-SW-___
2	3/4"	Grey TPR	110	2.75" (70)	1.95" (50)	Plain	RZ-02TPN-070-SW-___
3	7/8"	Grey Rubber	140	3.98" (101)	2.85" (73)	Ball Bearing	RZ-03GRP-090-SW-___
3	7/8"	Grey TPR	140	3.98" (101)	2.85" (73)	Ball Bearing	RZ-03TPP-090-SW-___
4	7/8"	Grey Rubber	160	4.84" (123)	3.35" (85)	Ball Bearing	RZ-04GRP-090-SW-___
4	7/8"	Grey TPR	160	4.84" (123)	3.35" (85)	Ball Bearing	RZ-04TPP-090-SW-___
5	7/8"	Grey Rubber	165	5.95" (151)	3.84" (98)	Ball Bearing	RZ-05GRP-090-SW-___
5	7/8"	Grey TPR	165	5.95" (151)	3.84" (98)	Ball Bearing	RZ-05TPP-090-SW-___



GRIP RING STEM TOTAL LOCK MODELS

(LOCKS WHEEL AND SWIVEL)

Wheel Diameter (Inches)	Tread Width (Inches)	Wheel Description	Capacity (Lbs)	Load Height Inches (mm)	Swivel Radius Inches (mm)	Wheel Bearing	Model Number
2	3/4"	Grey Rubber	110	2.75" (70)	3.23" (82)	Plain	RZ-02GRN-070-TL-___
2	3/4"	Grey TPR	110	2.75" (70)	3.23" (82)	Plain	RZ-02TPN-070-TL-___
3	7/8"	Grey Rubber	140	3.98" (101)	3.90" (104)	Ball Bearing	RZ-03GRP-090-TL-___
3	7/8"	Grey TPR	140	3.98" (101)	3.90" (104)	Ball Bearing	RZ-03TPP-090-TL-___
4	7/8"	Grey Rubber	160	4.84" (123)	4.19" (107)	Ball Bearing	RZ-04GRP-090-TL-___
4	7/8"	Grey TPR	160	4.84" (123)	4.19" (107)	Ball Bearing	RZ-04TPP-090-TL-___
5	7/8"	Grey Rubber	165	5.95" (151)	4.19" (107)	Ball Bearing	RZ-05GRP-090-TL-___
5	7/8"	Grey TPR	165	5.95" (151)	4.19" (107)	Ball Bearing	RZ-05TPP-090-TL-___



GRIP RING STEM FITTINGS

See fittings page for more options.



Specify Grip Ring Stem (GR) code, see fittings at left for dimensions.

RAZER (RZ)

THREADED STEM MODELS

FREE SWIVEL • TOTAL LOCK



Grey TPR Wheel Model (TPP)



NEW Grey Rubber Wheel (GRP)

APPLICATIONS

- Laundry Hampers
- Mobile Hospital Furniture
- Bassinets
- Hospital
- Chairs/ Recliners
- Home Healthcare Beds

FEATURES

- Economical
- Polished chrome finish
- Double ball swivel raceways for added strength
- **Total Lock Brake** models lock both swivel and wheel
- Full thread guards for added protection (except 2" diameter models)
- Ball bearings included on 3" to 5" wheel diameter models. Plain bearing on 2" model

THREADED STEM MODELS

Wheel Diameter (Inches)	Tread Width (Inches)	Wheel Description	Capacity (Lbs)	Load Height Inches (mm)	Swivel Radius Inches (mm)	Wheel Bearing	Model Number
2	3/4"	Grey Rubber	110	2.75" (70)	1.95" (50)	Plain	RZ-02GRN-070-SW-_____
2	3/4"	Grey TPR	110	2.75" (70)	1.95" (50)	Plain	RZ-02TPN-070-SW-_____
3	7/8"	Grey Rubber	140	3.98" (101)	2.85" (73)	Ball Bearing	RZ-03GRP-090-SW-_____
3	7/8"	Grey TPR	140	3.98" (101)	2.85" (73)	Ball Bearing	RZ-03TPP-090-SW-_____
4	7/8"	Grey Rubber	160	4.84" (123)	3.35" (85)	Ball Bearing	RZ-04GRP-090-SW-_____
4	7/8"	Grey TPR	160	4.84" (123)	3.35" (85)	Ball Bearing	RZ-04TPP-090-SW-_____
5	7/8"	Grey Rubber	165	5.95" (151)	3.84" (98)	Ball Bearing	RZ-05GRP-090-SW-_____
5	7/8"	Grey TPR	165	5.95" (151)	3.84" (98)	Ball Bearing	RZ-05TPP-090-SW-_____



THREADED STEM TOTAL LOCK MODELS

(LOCKS WHEEL AND SWIVEL)

Wheel Diameter (Inches)	Tread Width (Inches)	Wheel Description	Capacity (Lbs)	Load Height Inches (mm)	Swivel Radius Inches (mm)	Wheel Bearing	Model Number
2	3/4"	Grey Rubber	110	2.75" (70)	3.23" (82)	Plain	RZ-02GRN-070-TL-_____
2	3/4"	Grey TPR	110	2.75" (70)	3.23" (82)	Plain	RZ-02TPN-070-TL-_____
3	7/8"	Grey Rubber	140	3.98" (101)	3.90" (104)	Ball Bearing	RZ-03GRP-090-TL-_____
3	7/8"	Grey TPR	140	3.98" (101)	3.90" (104)	Ball Bearing	RZ-03TPP-090-TL-_____
4	7/8"	Grey Rubber	160	4.84" (123)	4.19" (107)	Ball Bearing	RZ-04GRP-090-TL-_____
4	7/8"	Grey TPR	160	4.84" (123)	4.19" (107)	Ball Bearing	RZ-04TPP-090-TL-_____
5	7/8"	Grey Rubber	165	5.95" (151)	4.19" (107)	Ball Bearing	RZ-05GRP-090-TL-_____
5	7/8"	Grey TPR	165	5.95" (151)	4.19" (107)	Ball Bearing	RZ-05TPP-090-TL-_____



THREADED STEM FITTINGS

See fittings page for more options.

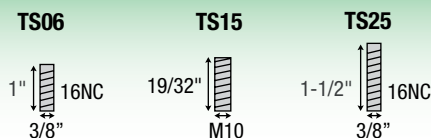

Specify Threaded Stem (TS) code, see fittings at left for dimensions:

CHROME HOSPITAL (CH)

TOP PLATE MODELS

FREE SWIVEL • TOTAL LOCK • DIRECTION LOCK



APPLICATIONS

- Food Service
- Case Carts
- Utility Carts
- Hospital Equipment
- Institutional Equipment
- Store Fixtures
- Medical equipment

New chrome thread guards now available!

FEATURES

- Chrome Plated Finish
- Dual Ball Swivel Raceways for added strength
- **Total Lock Brake** models lock both swivel and wheel
- Directional lock models lock swivel only (helps with steering)
- Precision ball bearings in wheels for easier rollability
- Wheels have full thread guards for added protection

The CH series brings you Chrome Hospital casters at an affordable price.

SWIVEL TOP PLATE MODELS

Wheel Diameter (Inches)	Tread Width (Inches)	Wheel Description	Capacity (Lbs)	Load Height Inches (mm)	Swivel Radius Inches (mm)	Wheel Bearing	Model Number
3	1-1/4	Conductive Rubber	190	4-7/16" (113)	2-29/32" (74)	Annular Ball	CH-03CRB-125-SW-___
3	1-1/4	Thermoplastic Rubber	190	4-7/16" (113)	2-29/32" (74)	Precision Ball	CH-03TPP-125-SW-___
3	1-1/4	Anti-Microbial TPR	190	4-7/16" (113)	2-29/32" (74)	Precision Ball	CH-03AMP-125-SW-___
3	1-1/4	Polyurethane TPU	190	4-7/16" (113)	2-29/32" (74)	Precision Ball	CH-03PYP-125-SW-___
4	1-1/4	Conductive Rubber	240	5-7/16" (138)	3-37/64" (91)	Annular Ball	CH-04CRB-125-SW-___
4	1-1/4	Thermoplastic Rubber	240	5-7/16" (138)	3-37/64" (91)	Precision Ball	CH-04TPP-125-SW-___
4	1-1/4	Anti-Microbial TPR	240	5-7/16" (138)	3-37/64" (91)	Precision Ball	CH-04AMP-125-SW-___
4	1-1/4	Polyurethane TPU	240	5-7/16" (138)	3-37/64" (91)	Precision Ball	CH-04PYP-125-SW-___
5	1-1/4	Conductive Rubber	260	6-7/16" (163)	4-7/32" (108)	Annular Ball	CH-05CRB-125-SW-___
5	1-1/4	Thermoplastic Rubber	260	6-7/16" (163)	4-7/32" (108)	Precision Ball	CH-05TPP-125-SW-___
5	1-1/4	Anti-Microbial TPR	260	6-7/16" (163)	4-7/32" (108)	Precision Ball	CH-05AMP-125-SW-___
5	1-1/4	Polyurethane TPU	260	6-7/16" (163)	4-7/32" (108)	Precision Ball	CH-05PYP-125-SW-___
6	1-1/4	Conductive Rubber	260	7-13/32" (188)	4-39/64 (117)	Annular Ball	CH-06CRB-125-SW-___
6	1-1/4	Thermoplastic Rubber	260	7-13/32" (188)	4-39/64 (117)	Precision Ball	CH-06TPP-125-SW-___
6	1-1/4	Anti-Microbial TPR	260	7-13/32" (188)	4-39/64 (117)	Precision Ball	CH-06AMP-125-SW-___
6	1-1/4	Polyurethane TPU	260	7-13/32" (188)	4-39/64 (117)	Precision Ball	CH-06PYP-125-SW-___



Anti-Microbial wheels have light green tread.



NEW



To order chrome thread guard add "CTG" to end of model (Example: CH05TPP-125-SW-TP01-CTG).



Rigid Models available change "SW" to "RG"

TOP PLATE FITTING

Swivel Top Plate Pattern

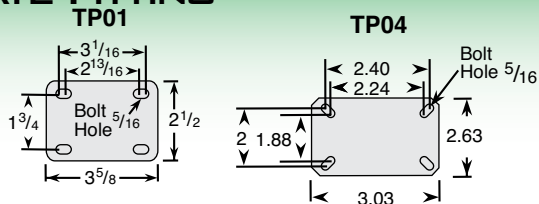

Specify Top Plate (TP) code, see fittings at left for dimensions.

CHROME HOSPITAL (CH)

SWIVEL TOP PLATE TOTAL LOCK MODELS (LOCKS WHEEL AND SWIVEL)

Wheel Diameter (Inches)	Tread Width (Inches)	Wheel Description	Capacity (Lbs)	Load Height Inches (mm)	Swivel Radius Inches (mm)	Wheel Bearing	Model Number
3	1-1/4	Conductive Rubber	190	4-7/16" (113)	4-1/4" (108)	Annular Ball	CH-03CRB-125-TL-__
3	1-1/4	Thermoplastic Rubber	190	4-7/16" (113)	4-1/4" (108)	Precision Ball	CH-03TPP-125-TL-__
3	1-1/4	Anti-Microbial TPR	190	4-7/16" (113)	4-1/4" (108)	Precision Ball	CH-03AMP-125-TL-__
3	1-1/4	Polyurethane TPU	190	4-7/16" (113)	4-1/4" (108)	Precision Ball	CH-03PYP-125-TL-__
4	1-1/4	Conductive Rubber	240	5-7/16" (138)	4-35/64" (115)	Annular Ball	CH-04CRB-125-TL-__
4	1-1/4	Thermoplastic Rubber	240	5-7/16" (138)	4-35/64" (115)	Precision Ball	CH-04TPP-125-TL-__
4	1-1/4	Anti-Microbial TPR	240	5-7/16" (138)	4-35/64" (115)	Precision Ball	CH-04AMP-125-TL-__
4	1-1/4	Polyurethane TPU	240	5-7/16" (138)	4-35/64" (115)	Precision Ball	CH-04PYP-125-TL-__
5	1-1/4	Conductive Rubber	260	6-7/16" (163)	4-55/64" (123)	Annular Ball	CH-05CRB-125-TL-__
5	1-1/4	Thermoplastic Rubber	260	6-7/16" (163)	4-55/64" (123)	Precision Ball	CH-05TPP-125-TL-__
5	1-1/4	Anti-Microbial TPR	260	6-7/16" (163)	4-55/64" (123)	Precision Ball	CH-05AMP-125-TL-__
5	1-1/4	Polyurethane TPU	260	6-7/16" (163)	4-55/64" (123)	Precision Ball	CH-05PYP-125-TL-__
6	1-1/4	Conductive Rubber	260	7-13/32" (188)	4-55/64" (123)	Annular Ball	CH-06CRB-125-TL-__
6	1-1/4	Thermoplastic Rubber	260	7-13/32" (188)	4-55/64" (123)	Precision Ball	CH-06TPP-125-TL-__
6	1-1/4	Anti-Microbial TPR	260	7-13/32" (188)	4-55/64" (123)	Precision Ball	CH-06AMP-125-TL-__
6	1-1/4	Polyurethane TPU	260	7-13/32" (188)	4-55/64" (123)	Precision Ball	CH-06PYP-125-TL-__



Total Lock
Change "SW" to "TL". **Red** sticker on pedal.

SWIVEL TOP PLATE DIRECTION LOCK MODELS (LOCKS SWIVEL ONLY)

Wheel Diameter (Inches)	Tread Width (Inches)	Wheel Description	Capacity (Lbs)	Load Height Inches (mm)	Swivel Radius Inches (mm)	Wheel Bearing	Model Number
3	1-1/4	Conductive Rubber	190	4-7/16" (113)	4-1/4" (108)	Annular Ball	CH-03CRB-125-DL-__
3	1-1/4	Thermoplastic Rubber	190	4-7/16" (113)	4-1/4" (108)	Precision Ball	CH-03TPP-125-DL-__
3	1-1/4	Anti-Microbial TPR	190	4-7/16" (113)	4-1/4" (108)	Precision Ball	CH-03AMP-125-DL-__
3	1-1/4	Polyurethane TPU	190	4-7/16" (113)	4-1/4" (108)	Precision Ball	CH-03PYP-125-DL-__
4	1-1/4	Conductive Rubber	240	5-7/16" (138)	4-35/64" (115)	Annular Ball	CH-04CRB-125-DL-__
4	1-1/4	Thermoplastic Rubber	240	5-7/16" (138)	4-35/64" (115)	Precision Ball	CH-04TPP-125-DL-__
4	1-1/4	Anti-Microbial TPR	240	5-7/16" (138)	4-35/64" (115)	Precision Ball	CH-04AMP-125-DL-__
4	1-1/4	Polyurethane TPU	240	5-7/16" (138)	4-35/64" (115)	Precision Ball	CH-04PYP-125-DL-__
5	1-1/4	Conductive Rubber	260	6-7/16" (163)	4-55/64" (123)	Annular Ball	CH-05CRB-125-DL-__
5	1-1/4	Thermoplastic Rubber	260	6-7/16" (163)	4-55/64" (123)	Precision Ball	CH-05TPP-125-DL-__
5	1-1/4	Anti-Microbial TPR	260	6-7/16" (163)	4-55/64" (123)	Precision Ball	CH-05AMP-125-DL-__
5	1-1/4	Polyurethane TPU	260	6-7/16" (163)	4-55/64" (123)	Precision Ball	CH-05PYP-125-DL-__
6	1-1/4	Conductive Rubber	260	7-13/32" (188)	4-55/64" (123)	Annular Ball	CH-06CRB-125-DL-__
6	1-1/4	Thermoplastic Rubber	260	7-13/32" (188)	4-55/64" (123)	Precision Ball	CH-06TPP-125-DL-__
6	1-1/4	Anti-Microbial TPR	260	7-13/32" (188)	4-55/64" (123)	Precision Ball	CH-06AMP-125-DL-__
6	1-1/4	Polyurethane TPU	260	7-13/32" (188)	4-55/64" (123)	Precision Ball	CH-06PYP-125-DL-__



Direction Lock
Change "SW" to "DL". **Green** sticker on pedal.

TOP PLATE FITTING

Swivel Top Plate Pattern

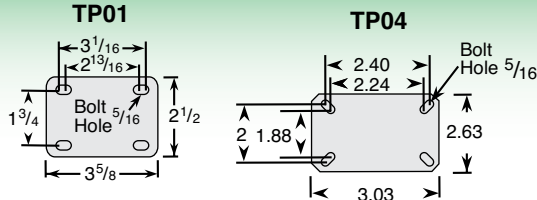

Specify Top Plate (TP) code, see fittings at left for dimensions.

CHROME HOSPITAL (CH)

HOLLOW KINGPIN MODELS
 FREE SWIVEL • TOTAL LOCK • DIRECTION LOCK



- APPLICATIONS**
- Food Service
 - Case Carts
 - Utility Carts
 - Hospital Equipment
 - Institutional Equipment
 - Store Fixtures
 - Medical equipment

New chrome thread guards now available!

- FEATURES**
- Chrome Plated Finish
 - Dual Ball Swivel Raceways for added strength
 - **Total Lock Brake** models lock both swivel and wheel
 - Directional lock models lock swivel only (helps with steering)
 - Precision ball bearings in wheels for easier rollability
 - Wheels have full thread guards for added protection

The CH series brings you Chrome Hospital casters at an affordable price.

HOLLOW KINGPIN MODELS

Wheel Diameter (Inches)	Tread Width (Inches)	Wheel Description	Capacity (lbs)	Load Height Inches (mm)	Swivel Radius Inches (mm)	Wheel Bearing	Model Number
3	1-1/4	Conductive Rubber	190	4-5/16" (109)	2-29/32" (74)	Annular Ball	CH-03CRB-125-SW-HKU1
3	1-1/4	Thermoplastic Rubber	190	4-5/16" (109)	2-29/32" (74)	Precision Ball	CH-03TPP-125-SW-HKU1
3	1-1/4	Anti-Microbial TPR	190	4-5/16" (109)	2-29/32" (74)	Precision Ball	CH-03AMP-125-SW-HKU1
3	1-1/4	Polyurethane TPU	190	4-5/16" (109)	2-29/32" (74)	Precision Ball	CH-03PYP-125-SW-HKU1
4	1-1/4	Conductive Rubber	240	5-5/16" (135)	3-37/64" (91)	Annular Ball	CH-04CRB-125-SW-HKU1
4	1-1/4	Thermoplastic Rubber	240	5-5/16" (135)	3-37/64" (91)	Precision Ball	CH-04TPP-125-SW-HKU1
4	1-1/4	Anti-Microbial TPR	240	5-5/16" (135)	3-37/64" (91)	Precision Ball	CH-04AMP-125-SW-HKU1
4	1-1/4	Polyurethane TPU	240	5-5/16" (135)	3-37/64" (91)	Precision Ball	CH-04PYP-125-SW-HKU1
5	1-1/4	Conductive Rubber	260	6-5/16" (160)	4-7/32" (108)	Annular Ball	CH-05CRB-125-SW-HKU1
5	1-1/4	Thermoplastic Rubber	260	6-5/16" (160)	4-7/32" (108)	Precision Ball	CH-05TPP-125-SW-HKU1
5	1-1/4	Anti-Microbial TPR	260	6-5/16" (160)	4-7/32" (108)	Precision Ball	CH-05AMP-125-SW-HKU1
5	1-1/4	Polyurethane TPU	260	6-5/16" (160)	4-7/32" (108)	Precision Ball	CH-05PYP-125-SW-HKU1
6	1-1/4	Conductive Rubber	260	7-9/32" (185)	4-39/64" (117)	Annular Ball	CH-06CRB-125-SW-HKU1
6	1-1/4	Thermoplastic Rubber	260	7-9/32" (185)	4-39/64" (117)	Precision Ball	CH-06TPP-125-SW-HKU1
6	1-1/4	Anti-Microbial TPR	260	7-9/32" (185)	4-39/64" (117)	Precision Ball	CH-06AMP-125-SW-HKU1
6	1-1/4	Polyurethane TPU	260	7-9/32" (185)	4-39/64" (117)	Precision Ball	CH-06PYP-125-SW-HKU1



Anti-Microbial wheels have light green tread.



NEW



To order chrome thread guard add "CTG" to end of model (Example: CH05TPP-125-SW-HK01-CTG).

HOLLOW KINGPIN

Caster is **provided unassembled** to make it easy to add your choice of fitting. If you would like these assembled change **HKU1** to **HK01**. 1/2 I.D.



CHROME HOSPITAL (CH)

HOLLOW KINGPIN MODELS

FREE SWIVEL • TOTAL LOCK • DIRECTION LOCK

HOLLOW KINGPIN TOTAL LOCK MODELS

(LOCKS WHEEL AND SWIVEL)

Wheel Diameter (Inches)	Tread Width (Inches)	Wheel Description	Capacity (Lbs)	Load Height Inches (mm)	Swivel Radius Inches (mm)	Wheel Bearing	Model Number
3	1-1/4	Conductive Rubber	190	4-5/16" (109)	4-1/4" (108)	Annular Ball	CH-03CRB-125-TL-HKU1
3	1-1/4	Thermoplastic Rubber	190	4-5/16" (109)	4-1/4" (108)	Precision Ball	CH-03TPP-125-TL-HKU1
3	1-1/4	Anti-Microbial TPR	190	4-5/16" (109)	4-1/4" (108)	Precision Ball	CH-03AMP-125-TL-HKU1
3	1-1/4	Polyurethane TPU	190	4-5/16" (109)	4-1/4" (108)	Precision Ball	CH-03PYP-125-TL-HKU1
4	1-1/4	Conductive Rubber	240	5-5/16" (135)	4-35/64" (115)	Annular Ball	CH-04CRB-125-TL-HKU1
4	1-1/4	Thermoplastic Rubber	240	5-5/16" (135)	4-35/64" (115)	Precision Ball	CH-04TPP-125-TL-HKU1
4	1-1/4	Anti-Microbial TPR	240	5-5/16" (135)	4-35/64" (115)	Precision Ball	CH-04AMP-125-TL-HKU1
4	1-1/4	Polyurethane TPU	240	5-5/16" (135)	4-35/64" (115)	Precision Ball	CH-04PYP-125-TL-HKU1
5	1-1/4	Conductive Rubber	260	6-5/16" (160)	4-55/64" (123)	Annular Ball	CH-05CRB-125-TL-HKU1
5	1-1/4	Thermoplastic Rubber	260	6-5/16" (160)	4-55/64" (123)	Precision Ball	CH-05TPP-125-TL-HKU1
5	1-1/4	Anti-Microbial TPR	260	6-5/16" (160)	4-55/64" (123)	Precision Ball	CH-05AMP-125-TL-HKU1
5	1-1/4	Polyurethane TPU	260	6-5/16" (160)	4-55/64" (123)	Precision Ball	CH-05PYP-125-TL-HKU1
6	1-1/4	Conductive Rubber	260	7-9/32" (185)	4-55/64" (123)	Annular Ball	CH-06CRB-125-TL-HKU1
6	1-1/4	Thermoplastic Rubber	260	7-9/32" (185)	4-55/64" (123)	Precision Ball	CH-06TPP-125-TL-HKU1
6	1-1/4	Anti-Microbial TPR	260	7-9/32" (185)	4-55/64" (123)	Precision Ball	CH-06AMP-125-TL-HKU1
6	1-1/4	Polyurethane TPU	260	7-9/32" (185)	4-55/64" (123)	Precision Ball	CH-06PYP-125-TL-HKU1



HOLLOW KINGPIN DIRECTION LOCK MODELS

(LOCKS SWIVEL ONLY)

Wheel Diameter (Inches)	Tread Width (Inches)	Wheel Description	Capacity (Lbs)	Load Height Inches (mm)	Swivel Radius Inches (mm)	Wheel Bearing	Model Number
3	1-1/4	Conductive Rubber	190	4-5/16" (109)	4-1/4" (108)	Annular Ball	CH-03CRB-125-DL-HKU1
3	1-1/4	Thermoplastic Rubber	190	4-5/16" (109)	4-1/4" (108)	Precision Ball	CH-03TPP-125-DL-HKU1
3	1-1/4	Anti-Microbial TPR	190	4-5/16" (109)	4-1/4" (108)	Precision Ball	CH-03AMP-125-DL-HKU1
3	1-1/4	Polyurethane TPU	190	4-5/16" (109)	4-1/4" (108)	Precision Ball	CH-03PYP-125-DL-HKU1
4	1-1/4	Conductive Rubber	240	5-5/16" (135)	4-35/64" (115)	Annular Ball	CH-04CRB-125-DL-HKU1
4	1-1/4	Thermoplastic Rubber	240	5-5/16" (135)	4-35/64" (115)	Precision Ball	CH-04TPP-125-DL-HKU1
4	1-1/4	Anti-Microbial TPR	240	5-5/16" (135)	4-35/64" (115)	Precision Ball	CH-04AMP-125-DL-HKU1
4	1-1/4	Polyurethane TPU	240	5-5/16" (135)	4-35/64" (115)	Precision Ball	CH-04PYP-125-DL-HKU1
5	1-1/4	Conductive Rubber	260	6-5/16" (160)	4-55/64" (123)	Annular Ball	CH-05CRB-125-DL-HKU1
5	1-1/4	Thermoplastic Rubber	260	6-5/16" (160)	4-55/64" (123)	Precision Ball	CH-05TPP-125-DL-HKU1
5	1-1/4	Anti-Microbial TPR	260	6-5/16" (160)	4-55/64" (123)	Precision Ball	CH-05AMP-125-DL-HKU1
5	1-1/4	Polyurethane TPU	260	6-5/16" (160)	4-55/64" (123)	Precision Ball	CH-05PYP-125-DL-HKU1
6	1-1/4	Conductive Rubber	260	7-9/32" (185)	4-55/64" (123)	Annular Ball	CH-06CRB-125-DL-HKU1
6	1-1/4	Thermoplastic Rubber	260	7-9/32" (185)	4-55/64" (123)	Precision Ball	CH-06TPP-125-DL-HKU1
6	1-1/4	Anti-Microbial TPR	260	7-9/32" (185)	4-55/64" (123)	Precision Ball	CH-06AMP-125-DL-HKU1
6	1-1/4	Polyurethane TPU	260	7-9/32" (185)	4-55/64" (123)	Precision Ball	CH-06PYP-125-DL-HKU1



HOLLOW KINGPIN

Caster is **provided unassembled** to make it easy to add your choice of fitting. If you would like these assembled change **HKU1** to **HK01**. 1/2 I.D.



CHROME HOSPITAL (CH)

GRIP RING STEM MODELS

FREE SWIVEL • TOTAL LOCK • DIRECTION LOCK



APPLICATIONS

- Food Service
- Case Carts
- Utility Carts
- Hospital Equipment
- Institutional Equipment
- Store Fixtures
- Medical equipment

New chrome thread guards now available!

FEATURES

- Chrome Plated Finish
- Dual Ball Swivel Raceways for added strength
- **Total Lock Brake** models lock both swivel and wheel
- Directional lock models lock swivel only (helps with steering)
- Precision ball bearings in wheels for easier rollability
- Wheels have full thread guards for added protection

The CH series brings you Chrome Hospital casters at an affordable price.

GRIP RING STEM MODELS

Wheel Diameter (Inches)	Tread Width (Inches)	Wheel Description	Capacity (lbs)	Load Height Inches (mm)	Swivel Radius Inches (mm)	Wheel Bearing	Model Number
3	1-1/4	Conductive Rubber	190	4-5/16" (109)	2-29/32" (74)	Annular Ball	CH-03CRB-125-SW-____
3	1-1/4	Thermoplastic Rubber	190	4-5/16" (109)	2-29/32" (74)	Precision Ball	CH-03TPP-125-SW-____
3	1-1/4	Anti-Microbial TPR	190	4-5/16" (109)	2-29/32" (74)	Precision Ball	CH-03AMP-125-SW-____
3	1-1/4	Polyurethane TPU	190	4-5/16" (109)	2-29/32" (74)	Precision Ball	CH-03PYP-125-SW-____
4	1-1/4	Conductive Rubber	240	5-5/16" (135)	3-37/64" (91)	Annular Ball	CH-04CRB-125-SW-____
4	1-1/4	Thermoplastic Rubber	240	5-5/16" (135)	3-37/64" (91)	Precision Ball	CH-04TPP-125-SW-____
4	1-1/4	Anti-Microbial TPR	240	5-5/16" (135)	3-37/64" (91)	Precision Ball	CH-04AMP-125-SW-____
4	1-1/4	Polyurethane TPU	240	5-5/16" (135)	3-37/64" (91)	Precision Ball	CH-04PYP-125-SW-____
5	1-1/4	Conductive Rubber	260	6-5/16" (160)	4-7/32" (108)	Annular Ball	CH-05CRB-125-SW-____
5	1-1/4	Thermoplastic Rubber	260	6-5/16" (160)	4-7/32" (108)	Precision Ball	CH-05TPP-125-SW-____
5	1-1/4	Anti-Microbial TPR	260	6-5/16" (160)	4-7/32" (108)	Precision Ball	CH-05AMP-125-SW-____
5	1-1/4	Polyurethane TPU	260	6-5/16" (160)	4-7/32" (108)	Precision Ball	CH-05PYP-125-SW-____
6	1-1/4	Conductive Rubber	260	7-9/32" (185)	4-39/64" (117)	Annular Ball	CH-06CRB-125-SW-____
6	1-1/4	Thermoplastic Rubber	260	7-9/32" (185)	4-39/64" (117)	Precision Ball	CH-06TPP-125-SW-____
6	1-1/4	Anti-Microbial TPR	260	7-9/32" (185)	4-39/64" (117)	Precision Ball	CH-06AMP-125-SW-____
6	1-1/4	Polyurethane TPU	260	7-9/32" (185)	4-39/64" (117)	Precision Ball	CH-06PYP-125-SW-____



Anti-Microbial wheels have light green tread.



NEW



To order chrome thread guard add "CTG" to end of model (Example: CH05TPP-125-SW-GR02-CTG).

GRIP RING STEM FITTINGS

See fittings page for more options.

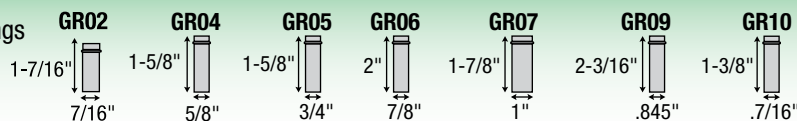

Specify Grip Ring Stem (GR) code, see fittings at left for dimensions.

CHROME HOSPITAL (CH)

GRIP RING STEM TOTAL LOCK MODELS (LOCKS WHEEL AND SWIVEL)

Wheel Diameter (Inches)	Tread Width (Inches)	Wheel Description	Capacity (Lbs)	Load Height Inches (mm)	Swivel Radius Inches (mm)	Wheel Bearing	Model Number
3	1-1/4	Conductive Rubber	190	4-5/16" (109)	4-1/4" (108)	Annular Ball	CH-03CRB-125-TL-____
3	1-1/4	Thermoplastic Rubber	190	4-5/16" (109)	4-1/4" (108)	Precision Ball	CH-03TPP-125-TL-____
3	1-1/4	Anti-Microbial TPR	190	4-5/16" (109)	4-1/4" (108)	Precision Ball	CH-03AMP-125-TL-____
3	1-1/4	Polyurethane TPU	190	4-5/16" (109)	4-1/4" (108)	Precision Ball	CH-03PYP-125-TL-____
4	1-1/4	Conductive Rubber	240	5-5/16" (135)	4-35/64" (115)	Annular Ball	CH-04CRB-125-TL-____
4	1-1/4	Thermoplastic Rubber	240	5-5/16" (135)	4-35/64" (115)	Precision Ball	CH-04TPP-125-TL-____
4	1-1/4	Anti-Microbial TPR	240	5-5/16" (135)	4-35/64" (115)	Precision Ball	CH-04AMP-125-TL-____
4	1-1/4	Polyurethane TPU	240	5-5/16" (135)	4-35/64" (115)	Precision Ball	CH-04PYP-125-TL-____
5	1-1/4	Conductive Rubber	260	6-5/16" (160)	4-55/64" (123)	Annular Ball	CH-05CRB-125-TL-____
5	1-1/4	Thermoplastic Rubber	260	6-5/16" (160)	4-55/64" (123)	Precision Ball	CH-05TPP-125-TL-____
5	1-1/4	Anti-Microbial TPR	260	6-5/16" (160)	4-55/64" (123)	Precision Ball	CH-05AMP-125-TL-____
5	1-1/4	Polyurethane TPU	260	6-5/16" (160)	4-55/64" (123)	Precision Ball	CH-05PYP-125-TL-____
6	1-1/4	Conductive Rubber	260	7-9/32" (185)	4-55/64" (123)	Annular Ball	CH-06CRB-125-TL-____
6	1-1/4	Thermoplastic Rubber	260	7-9/32" (185)	4-55/64" (123)	Precision Ball	CH-06TPP-125-TL-____
6	1-1/4	Anti-Microbial TPR	260	7-9/32" (185)	4-55/64" (123)	Precision Ball	CH-06AMP-125-TL-____
6	1-1/4	Polyurethane TPU	260	7-9/32" (185)	4-55/64" (123)	Precision Ball	CH-06PYP-125-TL-____



Total Lock
Change "SW"
to "TL". Red
sticker on pedal.

GRIP RING STEM DIRECTION LOCK MODELS (LOCKS SWIVEL ONLY)

Wheel Diameter (Inches)	Tread Width (Inches)	Wheel Description	Capacity (Lbs)	Load Height Inches (mm)	Swivel Radius Inches (mm)	Wheel Bearing	Model Number
3	1-1/4	Conductive Rubber	190	4-5/16" (109)	4-1/4" (108)	Annular Ball	CH-03CRB-125-DL-____
3	1-1/4	Thermoplastic Rubber	190	4-5/16" (109)	4-1/4" (108)	Precision Ball	CH-03TPP-125-DL-____
3	1-1/4	Anti-Microbial TPR	190	4-5/16" (109)	4-1/4" (108)	Precision Ball	CH-03AMP-125-DL-____
3	1-1/4	Polyurethane TPU	190	4-5/16" (109)	4-1/4" (108)	Precision Ball	CH-03PYP-125-DL-____
4	1-1/4	Conductive Rubber	240	5-5/16" (135)	4-35/64" (115)	Annular Ball	CH-04CRB-125-DL-____
4	1-1/4	Thermoplastic Rubber	240	5-5/16" (135)	4-35/64" (115)	Precision Ball	CH-04TPP-125-DL-____
4	1-1/4	Anti-Microbial TPR	240	5-5/16" (135)	4-35/64" (115)	Precision Ball	CH-04AMP-125-DL-____
4	1-1/4	Polyurethane TPU	240	5-5/16" (135)	4-35/64" (115)	Precision Ball	CH-04PYP-125-DL-____
5	1-1/4	Conductive Rubber	260	6-5/16" (160)	4-55/64" (123)	Annular Ball	CH-05CRB-125-DL-____
5	1-1/4	Thermoplastic Rubber	260	6-5/16" (160)	4-55/64" (123)	Precision Ball	CH-05TPP-125-DL-____
5	1-1/4	Anti-Microbial TPR	260	6-5/16" (160)	4-55/64" (123)	Precision Ball	CH-05AMP-125-DL-____
5	1-1/4	Polyurethane TPU	260	6-5/16" (160)	4-55/64" (123)	Precision Ball	CH-05PYP-125-DL-____
6	1-1/4	Conductive Rubber	260	7-9/32" (185)	4-55/64" (123)	Annular Ball	CH-06CRB-125-DL-____
6	1-1/4	Thermoplastic Rubber	260	7-9/32" (185)	4-55/64" (123)	Precision Ball	CH-06TPP-125-DL-____
6	1-1/4	Anti-Microbial TPR	260	7-9/32" (185)	4-55/64" (123)	Precision Ball	CH-06AMP-125-DL-____
6	1-1/4	Polyurethane TPU	260	7-9/32" (185)	4-55/64" (123)	Precision Ball	CH-06PYP-125-DL-____



Direction Lock
Change "SW"
to "DL". Green
sticker on pedal.

Specify Grip Ring Stem (GR) code, see fittings at left for dimensions.

GRIP RING STEM FITTINGS

See fittings page for more options.

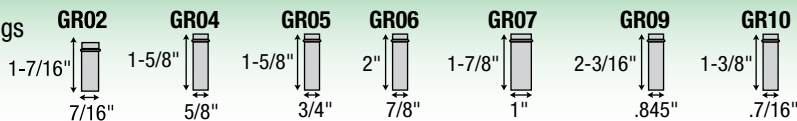

CHROME HOSPITAL (CH)

EXPANDING ADAPTER STEM MODELS
 FREE SWIVEL • TOTAL LOCK • DIRECTION LOCK



- APPLICATIONS**
- Food Service
 - Case Carts
 - Utility Carts
 - Hospital Equipment
 - Institutional Equipment
 - Store Fixtures
 - Medical equipment

New chrome thread guards now available!

- FEATURES**
- Chrome Plated Finish
 - Dual Ball Swivel Raceways for added strength
 - **Total Lock Brake** models lock both swivel and wheel
 - Directional lock models lock swivel only (helps with steering)
 - Precision ball bearings in wheels for easier rollability
 - Wheels have full thread guards for added protection

The CH series brings you Chrome Hospital casters at an affordable price.

EXPANDING ADAPTER STEM MODELS

Wheel Diameter (Inches)	Tread Width (Inches)	Wheel Description	Capacity (Lbs)	Load Height Inches (mm)	Swivel Radius Inches (mm)	Wheel Bearing	Model Number
3	1-1/4	Conductive Rubber	190	4-5/16" (109)	2-29/32" (74)	Annular Ball	CH-03CRB-125-SW-___
3	1-1/4	Thermoplastic Rubber	190	4-5/16" (109)	2-29/32" (74)	Precision Ball	CH-03TPP-125-SW-___
3	1-1/4	Anti-Microbial TPR	190	4-5/16" (109)	2-29/32" (74)	Precision Ball	CH-03AMP-125-SW-___
3	1-1/4	Polyurethane TPU	190	4-5/16" (109)	2-29/32" (74)	Precision Ball	CH-03PYP-125-SW-___
4	1-1/4	Conductive Rubber	240	5-5/16" (135)	3-37/64" (91)	Annular Ball	CH-04CRB-125-SW-___
4	1-1/4	Thermoplastic Rubber	240	5-5/16" (135)	3-37/64" (91)	Precision Ball	CH-04TPP-125-SW-___
4	1-1/4	Anti-Microbial TPR	240	5-5/16" (135)	3-37/64" (91)	Precision Ball	CH-04AMP-125-SW-___
4	1-1/4	Polyurethane TPU	240	5-5/16" (135)	3-37/64" (91)	Precision Ball	CH-04PYP-125-SW-___
5	1-1/4	Conductive Rubber	260	6-5/16" (160)	4-7/32" (108)	Annular Ball	CH-05CRB-125-SW-___
5	1-1/4	Thermoplastic Rubber	260	6-5/16" (160)	4-7/32" (108)	Precision Ball	CH-05TPP-125-SW-___
5	1-1/4	Anti-Microbial TPR	260	6-5/16" (160)	4-7/32" (108)	Precision Ball	CH-05AMP-125-SW-___
5	1-1/4	Polyurethane TPU	260	6-5/16" (160)	4-7/32" (108)	Precision Ball	CH-05PYP-125-SW-___
6	1-1/4	Conductive Rubber	260	7-9/32" (185)	4-39/64" (117)	Annular Ball	CH-06CRB-125-SW-___
6	1-1/4	Thermoplastic Rubber	260	7-9/32" (185)	4-39/64" (117)	Precision Ball	CH-06TPP-125-SW-___
6	1-1/4	Anti-Microbial TPR	260	7-9/32" (185)	4-39/64" (117)	Precision Ball	CH-06AMP-125-SW-___
6	1-1/4	Polyurethane TPU	260	7-9/32" (185)	4-39/64" (117)	Precision Ball	CH-06PYP-125-SW-___



Anti-Microbial wheels have light green tread.



NEW To order chrome thread guard add "CTG" to end of model (Example: CH05TPP-125-SW-XRN1-CTG).

Specify Expanding Adapter Stem (XR) code, see fittings at left for dimensions.

EXPANDING ADAPTER STEM FITTINGS

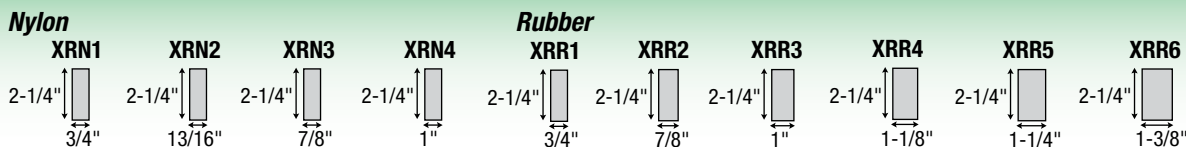

See fittings page for descriptions and more options.

CHROME HOSPITAL (CH)

EXPANDING ADAPTER STEM TOTAL LOCK MODELS (LOCKS WHEEL AND SWIVEL)

Wheel Diameter (Inches)	Tread Width (Inches)	Wheel Description	Capacity (Lbs)	Load Height Inches (mm)	Swivel Radius Inches (mm)	Wheel Bearing	Model Number
3	1-1/4	Conductive Rubber	190	4-5/16" (109)	4-1/4" (108)	Annular Ball	CH-03CRB-125-TL-_____
3	1-1/4	Thermoplastic Rubber	190	4-5/16" (109)	4-1/4" (108)	Precision Ball	CH-03TPP-125-TL-_____
3	1-1/4	Anti-Microbial TPR	190	4-5/16" (109)	4-1/4" (108)	Precision Ball	CH-03AMP-125-TL-_____
3	1-1/4	Polyurethane TPU	190	4-5/16" (109)	4-1/4" (108)	Precision Ball	CH-03PYP-125-TL-_____
4	1-1/4	Conductive Rubber	240	5-5/16" (135)	4-35/64" (115)	Annular Ball	CH-04CRB-125-TL-_____
4	1-1/4	Thermoplastic Rubber	240	5-5/16" (135)	4-35/64" (115)	Precision Ball	CH-04TPP-125-TL-_____
4	1-1/4	Anti-Microbial TPR	240	5-5/16" (135)	4-35/64" (115)	Precision Ball	CH-04AMP-125-TL-_____
4	1-1/4	Polyurethane TPU	240	5-5/16" (135)	4-35/64" (115)	Precision Ball	CH-04PYP-125-TL-_____
5	1-1/4	Conductive Rubber	260	6-5/16" (160)	4-55/64" (123)	Annular Ball	CH-05CRB-125-TL-_____
5	1-1/4	Thermoplastic Rubber	260	6-5/16" (160)	4-55/64" (123)	Precision Ball	CH-05TPP-125-TL-_____
5	1-1/4	Anti-Microbial TPR	260	6-5/16" (160)	4-55/64" (123)	Precision Ball	CH-05AMP-125-TL-_____
5	1-1/4	Polyurethane TPU	260	6-5/16" (160)	4-55/64" (123)	Precision Ball	CH-05PYP-125-TL-_____
6	1-1/4	Conductive Rubber	260	7-9/32" (185)	4-55/64" (123)	Annular Ball	CH-06CRB-125-TL-_____
6	1-1/4	Thermoplastic Rubber	260	7-9/32" (185)	4-55/64" (123)	Precision Ball	CH-06TPP-125-TL-_____
6	1-1/4	Anti-Microbial TPR	260	7-9/32" (185)	4-55/64" (123)	Precision Ball	CH-06AMP-125-TL-_____
6	1-1/4	Polyurethane TPU	260	7-9/32" (185)	4-55/64" (123)	Precision Ball	CH-06PYP-125-TL-_____



Total Lock
Change "SW" to "TL". **Red** sticker on pedal.

EXPANDING ADAPTER STEM DIRECTION LOCK MODELS (LOCKS SWIVEL ONLY)

Wheel Diameter (Inches)	Tread Width (Inches)	Wheel Description	Capacity (Lbs)	Load Height Inches (mm)	Swivel Radius Inches (mm)	Wheel Bearing	Model Number
3	1-1/4	Conductive Rubber	190	4-5/16" (109)	4-1/4" (108)	Annular Ball	CH-03CRB-125-DL-_____
3	1-1/4	Thermoplastic Rubber	190	4-5/16" (109)	4-1/4" (108)	Precision Ball	CH-03TPP-125-DL-_____
3	1-1/4	Anti-Microbial TPR	190	4-5/16" (109)	4-1/4" (108)	Precision Ball	CH-03AMP-125-DL-_____
3	1-1/4	Polyurethane TPU	190	4-5/16" (109)	4-1/4" (108)	Precision Ball	CH-03PYP-125-DL-_____
4	1-1/4	Conductive Rubber	240	5-5/16" (135)	4-35/64" (115)	Annular Ball	CH-04CRB-125-DL-_____
4	1-1/4	Thermoplastic Rubber	240	5-5/16" (135)	4-35/64" (115)	Precision Ball	CH-04TPP-125-DL-_____
4	1-1/4	Anti-Microbial TPR	240	5-5/16" (135)	4-35/64" (115)	Precision Ball	CH-04AMP-125-DL-_____
4	1-1/4	Polyurethane TPU	240	5-5/16" (135)	4-35/64" (115)	Precision Ball	CH-04PYP-125-DL-_____
5	1-1/4	Conductive Rubber	260	6-5/16" (160)	4-55/64" (123)	Annular Ball	CH-05CRB-125-DL-_____
5	1-1/4	Thermoplastic Rubber	260	6-5/16" (160)	4-55/64" (123)	Precision Ball	CH-05TPP-125-DL-_____
5	1-1/4	Anti-Microbial TPR	260	6-5/16" (160)	4-55/64" (123)	Precision Ball	CH-05AMP-125-DL-_____
5	1-1/4	Polyurethane TPU	260	6-5/16" (160)	4-55/64" (123)	Precision Ball	CH-05PYP-125-DL-_____
6	1-1/4	Conductive Rubber	260	7-9/32" (185)	4-55/64" (123)	Annular Ball	CH-06CRB-125-DL-_____
6	1-1/4	Thermoplastic Rubber	260	7-9/32" (185)	4-55/64" (123)	Precision Ball	CH-06TPP-125-DL-_____
6	1-1/4	Anti-Microbial TPR	260	7-9/32" (185)	4-55/64" (123)	Precision Ball	CH-06AMP-125-DL-_____
6	1-1/4	Polyurethane TPU	260	7-9/32" (185)	4-55/64" (123)	Precision Ball	CH-06PYP-125-DL-_____



Direction Lock
Change "SW" to "DL". **Green** sticker on pedal.

Specify Expanding Adapter Stem (XR) code, see fittings at left for dimensions.

EXPANDING ADAPTER STEM FITTINGS

Nylon				Rubber					
XRN1	XRN2	XRN3	XRN4	XRR1	XRR2	XRR3	XRR4	XRR5	XRR6
2-1/4" ↑ 3/4"	2-1/4" ↑ 13/16"	2-1/4" ↑ 7/8"	2-1/4" ↑ 1"	2-1/4" ↑ 3/4"	2-1/4" ↑ 7/8"	2-1/4" ↑ 1"	2-1/4" ↑ 1-1/8"	2-1/4" ↑ 1-1/4"	2-1/4" ↑ 1-3/8"

CHROME HOSPITAL (CH)

THREADED STEM MODELS
 FREE SWIVEL • TOTAL LOCK • DIRECTION LOCK



- APPLICATIONS**
- Food Service
 - Case Carts
 - Utility Carts
 - Hospital Equipment
 - Institutional Equipment
 - Store Fixtures
 - Medical equipment

New chrome thread guards now available!

- FEATURES**
- Chrome Plated Finish
 - Dual Ball Swivel Raceways for added strength
 - **Total Lock Brake** models lock both swivel and wheel
 - Directional lock models lock swivel only (helps with Steering)
 - Precision ball bearings in wheels for easier rollability
 - Wheels have full thread guards for added protection

The CH series brings you Chrome Hospital casters at an affordable price.

THREADED STEM MODELS

Wheel Diameter (Inches)	Tread Width (Inches)	Wheel Description	Capacity (Lbs)	Load Height Inches (mm)	Swivel Radius Inches (mm)	Wheel Bearing	Model Number
3	1-1/4	Conductive Rubber	190	4-5/16" (109)	2-29/32" (74)	Annular Ball	CH-03CRB-125-SW-_____
3	1-1/4	Thermoplastic Rubber	190	4-5/16" (109)	2-29/32" (74)	Precision Ball	CH-03TPP-125-SW-_____
3	1-1/4	Anti-Microbial TPR	190	4-5/16" (109)	2-29/32" (74)	Precision Ball	CH-03AMP-125-SW-_____
3	1-1/4	Polyurethane TPU	190	4-5/16" (109)	2-29/32" (74)	Precision Ball	CH-03PYP-125-SW-_____
4	1-1/4	Conductive Rubber	240	5-5/16" (135)	3-37/64" (91)	Annular Ball	CH-04CRB-125-SW-_____
4	1-1/4	Thermoplastic Rubber	240	5-5/16" (135)	3-37/64" (91)	Precision Ball	CH-04TPP-125-SW-_____
4	1-1/4	Anti-Microbial TPR	240	5-5/16" (135)	3-37/64" (91)	Precision Ball	CH-04AMP-125-SW-_____
4	1-1/4	Polyurethane TPU	240	5-5/16" (135)	3-37/64" (91)	Precision Ball	CH-04PYP-125-SW-_____
5	1-1/4	Conductive Rubber	260	6-5/16" (160)	4-7/32" (108)	Annular Ball	CH-05CRB-125-SW-_____
5	1-1/4	Thermoplastic Rubber	260	6-5/16" (160)	4-7/32" (108)	Precision Ball	CH-05TPP-125-SW-_____
5	1-1/4	Anti-Microbial TPR	260	6-5/16" (160)	4-7/32" (108)	Precision Ball	CH-05AMP-125-SW-_____
5	1-1/4	Polyurethane TPU	260	6-5/16" (160)	4-7/32" (108)	Precision Ball	CH-05PYP-125-SW-_____
6	1-1/4	Conductive Rubber	260	7-9/32" (185)	4-39/64" (117)	Annular Ball	CH-06CRB-125-SW-_____
6	1-1/4	Thermoplastic Rubber	260	7-9/32" (185)	4-39/64" (117)	Precision Ball	CH-06TPP-125-SW-_____
6	1-1/4	Anti-Microbial TPR	260	7-9/32" (185)	4-39/64" (117)	Precision Ball	CH-06AMP-125-SW-_____
6	1-1/4	Polyurethane TPU	260	7-9/32" (185)	4-39/64" (117)	Precision Ball	CH-06PYP-125-SW-_____



Anti-Microbial wheels have light green tread.



NEW



To order chrome thread guard add "CTG" to end of model
 (Example: CH05TPP-125-SW-TS02-CTG).

THREADED STEM FITTINGS

See fittings page for more easy to install stem options.

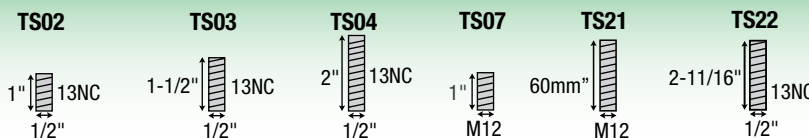

Specify Threaded Stem (TS) code, see fittings at left for dimensions:

CHROME HOSPITAL (CH)

THREADED STEM TOTAL LOCK MODELS (LOCKS WHEEL AND SWIVEL)

Wheel Diameter (Inches)	Tread Width (Inches)	Wheel Description	Capacity (Lbs)	Load Height Inches (mm)	Swivel Radius Inches (mm)	Wheel Bearing	Model Number
3	1-1/4	Conductive Rubber	190	4-5/16" (109)	4-1/4" (108)	Annular Ball	CH-03CRB-125-TL-____
3	1-1/4	Thermoplastic Rubber	190	4-5/16" (109)	4-1/4" (108)	Precision Ball	CH-03TPP-125-TL-____
3	1-1/4	Anti-Microbial TPR	190	4-5/16" (109)	4-1/4" (108)	Precision Ball	CH-03AMP-125-TL-____
3	1-1/4	Polyurethane TPU	190	4-5/16" (109)	4-1/4" (108)	Precision Ball	CH-03PYP-125-TL-____
4	1-1/4	Conductive Rubber	240	5-5/16" (135)	4-35/64" (115)	Annular Ball	CH-04CRB-125-TL-____
4	1-1/4	Thermoplastic Rubber	240	5-5/16" (135)	4-35/64" (115)	Precision Ball	CH-04TPP-125-TL-____
4	1-1/4	Anti-Microbial TPR	240	5-5/16" (135)	4-35/64" (115)	Precision Ball	CH-04AMP-125-TL-____
4	1-1/4	Polyurethane TPU	240	5-5/16" (135)	4-35/64" (115)	Precision Ball	CH-04PYP-125-TL-____
5	1-1/4	Conductive Rubber	260	6-5/16" (160)	4-55/64" (123)	Annular Ball	CH-05CRB-125-TL-____
5	1-1/4	Thermoplastic Rubber	260	6-5/16" (160)	4-55/64" (123)	Precision Ball	CH-05TPP-125-TL-____
5	1-1/4	Anti-Microbial TPR	260	6-5/16" (160)	4-55/64" (123)	Precision Ball	CH-05AMP-125-TL-____
5	1-1/4	Polyurethane TPU	260	6-5/16" (160)	4-55/64" (123)	Precision Ball	CH-05PYP-125-TL-____
6	1-1/4	Conductive Rubber	260	7-9/32" (185)	4-55/64" (123)	Annular Ball	CH-06CRB-125-TL-____
6	1-1/4	Thermoplastic Rubber	260	7-9/32" (185)	4-55/64" (123)	Precision Ball	CH-06TPP-125-TL-____
6	1-1/4	Anti-Microbial TPR	260	7-9/32" (185)	4-55/64" (123)	Precision Ball	CH-06AMP-125-TL-____
6	1-1/4	Polyurethane TPU	260	7-9/32" (185)	4-55/64" (123)	Precision Ball	CH-06PYP-125-TL-____



Total Lock
Change "SW" to "TL". Red sticker on pedal.

THREADED STEM DIRECTION LOCK MODELS (LOCKS SWIVEL ONLY)

Wheel Diameter (Inches)	Tread Width (Inches)	Wheel Description	Capacity (Lbs)	Load Height Inches (mm)	Swivel Radius Inches (mm)	Wheel Bearing	Model Number
3	1-1/4	Conductive Rubber	190	4-5/16" (109)	4-1/4" (108)	Annular Ball	CH-03CRB-125-DL-____
3	1-1/4	Thermoplastic Rubber	190	4-5/16" (109)	4-1/4" (108)	Precision Ball	CH-03TPP-125-DL-____
3	1-1/4	Anti-Microbial TPR	190	4-5/16" (109)	4-1/4" (108)	Precision Ball	CH-03AMP-125-DL-____
3	1-1/4	Polyurethane TPU	190	4-5/16" (109)	4-1/4" (108)	Precision Ball	CH-03PYP-125-DL-____
4	1-1/4	Conductive Rubber	240	5-5/16" (135)	4-35/64" (115)	Annular Ball	CH-04CRB-125-DL-____
4	1-1/4	Thermoplastic Rubber	240	5-5/16" (135)	4-35/64" (115)	Precision Ball	CH-04TPP-125-DL-____
4	1-1/4	Anti-Microbial TPR	240	5-5/16" (135)	4-35/64" (115)	Precision Ball	CH-04AMP-125-DL-____
4	1-1/4	Polyurethane TPU	240	5-5/16" (135)	4-35/64" (115)	Precision Ball	CH-04PYP-125-DL-____
5	1-1/4	Conductive Rubber	260	6-5/16" (160)	4-55/64" (123)	Annular Ball	CH-05CRB-125-DL-____
5	1-1/4	Thermoplastic Rubber	260	6-5/16" (160)	4-55/64" (123)	Precision Ball	CH-05TPP-125-DL-____
5	1-1/4	Anti-Microbial TPR	260	6-5/16" (160)	4-55/64" (123)	Precision Ball	CH-05AMP-125-DL-____
5	1-1/4	Polyurethane TPU	260	6-5/16" (160)	4-55/64" (123)	Precision Ball	CH-05PYP-125-DL-____
6	1-1/4	Conductive Rubber	260	7-9/32" (185)	4-55/64" (123)	Annular Ball	CH-06CRB-125-DL-____
6	1-1/4	Thermoplastic Rubber	260	7-9/32" (185)	4-55/64" (123)	Precision Ball	CH-06TPP-125-DL-____
6	1-1/4	Anti-Microbial TPR	260	7-9/32" (185)	4-55/64" (123)	Precision Ball	CH-06AMP-125-DL-____
6	1-1/4	Polyurethane TPU	260	7-9/32" (185)	4-55/64" (123)	Precision Ball	CH-06PYP-125-DL-____



Direction Lock
Change "SW" to "DL". Green sticker on pedal.

Specify Threaded Stem (TS) code, see fittings at left for dimensions:

THREADED STEM FITTINGS

See fittings page for more easy to install stem options.

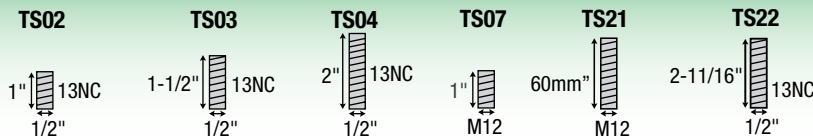

CHROME HOSPITAL (CH)

ROUND/SQUARE STEM MODELS
FREE SWIVEL • TOTAL LOCK • DIRECTION LOCK



- APPLICATIONS**
- Food Service
 - Case Carts
 - Utility Carts
 - Hospital Equipment
 - Institutional Equipment
 - Store Fixtures
 - Medical equipment

New chrome thread guards now available!

- FEATURES**
- Chrome Plated Finish
 - Dual Ball Swivel Raceways for added strength
 - **Total Lock Brake** models lock both swivel and wheel
 - Directional lock models lock swivel only (helps with steering)
 - Precision ball bearings in wheels for easier rollability
 - Wheels have full thread guards for added protection

The CH series brings you Chrome Hospital casters at an affordable price.

SQUARE/ROUND STEM FREE SWIVEL MODELS

Wheel Diameter (Inches)	Tread Width (Inches)	Wheel Description	Capacity (Lbs)	Load Height Inches (mm)	Swivel Radius Inches (mm)	Wheel Bearing	Model Number
3	1-1/4	Conductive Rubber	190	4-5/16" (109)	2-29/32" (74)	Annular Ball	CH-03CRB-125-SW-____
3	1-1/4	Thermoplastic Rubber	190	4-5/16" (109)	2-29/32" (74)	Precision Ball	CH-03TPP-125-SW-____
3	1-1/4	Anti-Microbial TPR	190	4-5/16" (109)	2-29/32" (74)	Precision Ball	CH-03AMP-125-SW-____
3	1-1/4	Polyurethane TPU	190	4-5/16" (109)	2-29/32" (74)	Precision Ball	CH-03PYP-125-SW-____
4	1-1/4	Conductive Rubber	240	5-5/16" (135)	3-37/64" (91)	Annular Ball	CH-04CRB-125-SW-____
4	1-1/4	Thermoplastic Rubber	240	5-5/16" (135)	3-37/64" (91)	Precision Ball	CH-04TPP-125-SW-____
4	1-1/4	Anti-Microbial TPR	240	5-5/16" (135)	3-37/64" (91)	Precision Ball	CH-04AMP-125-SW-____
4	1-1/4	Polyurethane TPU	240	5-5/16" (135)	3-37/64" (91)	Precision Ball	CH-04PYP-125-SW-____
5	1-1/4	Conductive Rubber	260	6-5/16" (160)	4-7/32" (108)	Annular Ball	CH-05CRB-125-SW-____
5	1-1/4	Thermoplastic Rubber	260	6-5/16" (160)	4-7/32" (108)	Precision Ball	CH-05TPP-125-SW-____
5	1-1/4	Anti-Microbial TPR	260	6-5/16" (160)	4-7/32" (108)	Precision Ball	CH-05AMP-125-SW-____
5	1-1/4	Polyurethane TPU	260	6-5/16" (160)	4-7/32" (108)	Precision Ball	CH-05PYP-125-SW-____
6	1-1/4	Conductive Rubber	260	7-9/32" (185)	4-39/64" (117)	Annular Ball	CH-06CRB-125-SW-____
6	1-1/4	Thermoplastic Rubber	260	7-9/32" (185)	4-39/64" (117)	Precision Ball	CH-06TPP-125-SW-____
6	1-1/4	Anti-Microbial TPR	260	7-9/32" (185)	4-39/64" (117)	Precision Ball	CH-06AMP-125-SW-____
6	1-1/4	Polyurethane TPU	260	7-9/32" (185)	4-39/64" (117)	Precision Ball	CH-06PYP-125-SW-____



Rigid models available. Consult factory.

Anti-Microbial wheels have light green tread.



NEW



To order chrome thread guard add "CTG" to end of model (Example: CH05TPP-125-SW-RS01-CTG).

Specify Round Stem (RS) code, Square stem specify (SQ) code. See fittings at left for dimensions..

ROUND STEM FITTINGS

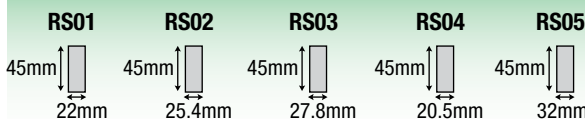

See fittings page for more options.

SQUARE STEM FITTINGS



CHROME HOSPITAL (CH)

SQUARE/ROUND STEM TOTAL LOCK MODELS (LOCKS WHEEL AND SWIVEL)

Wheel Diameter (Inches)	Tread Width (Inches)	Wheel Description	Capacity (Lbs)	Load Height Inches (mm)	Swivel Radius Inches (mm)	Wheel Bearing	Model Number
3	1-1/4	Conductive Rubber	190	4-5/16" (109)	4-1/4" (108)	Annular Ball	CH-03CRB-125-TL-____
3	1-1/4	Thermoplastic Rubber	190	4-5/16" (109)	4-1/4" (108)	Precision Ball	CH-03TPP-125-TL-____
3	1-1/4	Anti-Microbial TPR	190	4-5/16" (109)	4-1/4" (108)	Precision Ball	CH-03AMP-125-TL-____
3	1-1/4	Polyurethane TPU	190	4-5/16" (109)	4-1/4" (108)	Precision Ball	CH-03PYP-125-TL-____
4	1-1/4	Conductive Rubber	240	5-5/16" (135)	4-35/64" (115)	Annular Ball	CH-04CRB-125-TL-____
4	1-1/4	Thermoplastic Rubber	240	5-5/16" (135)	4-35/64" (115)	Precision Ball	CH-04TPP-125-TL-____
4	1-1/4	Anti-Microbial TPR	240	5-5/16" (135)	4-35/64" (115)	Precision Ball	CH-04AMP-125-TL-____
4	1-1/4	Polyurethane TPU	240	5-5/16" (135)	4-35/64" (115)	Precision Ball	CH-04PYP-125-TL-____
5	1-1/4	Conductive Rubber	260	6-5/16" (160)	4-55/64" (123)	Annular Ball	CH-05CRB-125-TL-____
5	1-1/4	Thermoplastic Rubber	260	6-5/16" (160)	4-55/64" (123)	Precision Ball	CH-05TPP-125-TL-____
5	1-1/4	Anti-Microbial TPR	260	6-5/16" (160)	4-55/64" (123)	Precision Ball	CH-05AMP-125-TL-____
5	1-1/4	Polyurethane TPU	260	6-5/16" (160)	4-55/64" (123)	Precision Ball	CH-05PYP-125-TL-____
6	1-1/4	Conductive Rubber	260	7-9/32" (185)	4-55/64" (123)	Annular Ball	CH-06CRB-125-TL-____
6	1-1/4	Thermoplastic Rubber	260	7-9/32" (185)	4-55/64" (123)	Precision Ball	CH-06TPP-125-TL-____
6	1-1/4	Anti-Microbial TPR	260	7-9/32" (185)	4-55/64" (123)	Precision Ball	CH-06AMP-125-TL-____
6	1-1/4	Polyurethane TPU	260	7-9/32" (185)	4-55/64" (123)	Precision Ball	CH-06PYP-125-TL-____



Total Lock
Change "SW" to "TL". **Red** sticker on pedal.

SQUARE/ROUND STEM DIRECTION LOCK MODELS (LOCKS SWIVEL ONLY)

Wheel Diameter (Inches)	Tread Width (Inches)	Wheel Description	Capacity (Lbs)	Load Height Inches (mm)	Swivel Radius Inches (mm)	Wheel Bearing	Model Number
3	1-1/4	Conductive Rubber	190	4-5/16" (109)	4-1/4" (108)	Annular Ball	CH-03CRB-125-DL-____
3	1-1/4	Thermoplastic Rubber	190	4-5/16" (109)	4-1/4" (108)	Precision Ball	CH-03TPP-125-DL-____
3	1-1/4	Anti-Microbial TPR	190	4-5/16" (109)	4-1/4" (108)	Precision Ball	CH-03AMP-125-DL-____
3	1-1/4	Polyurethane TPU	190	4-5/16" (109)	4-1/4" (108)	Precision Ball	CH-03PYP-125-DL-____
4	1-1/4	Conductive Rubber	240	5-5/16" (135)	4-35/64" (115)	Annular Ball	CH-04CRB-125-DL-____
4	1-1/4	Thermoplastic Rubber	240	5-5/16" (135)	4-35/64" (115)	Precision Ball	CH-04TPP-125-DL-____
4	1-1/4	Anti-Microbial TPR	240	5-5/16" (135)	4-35/64" (115)	Precision Ball	CH-04AMP-125-DL-____
4	1-1/4	Polyurethane TPU	240	5-5/16" (135)	4-35/64" (115)	Precision Ball	CH-04PYP-125-DL-____
5	1-1/4	Conductive Rubber	260	6-5/16" (160)	4-55/64" (123)	Annular Ball	CH-05CRB-125-DL-____
5	1-1/4	Thermoplastic Rubber	260	6-5/16" (160)	4-55/64" (123)	Precision Ball	CH-05TPP-125-DL-____
5	1-1/4	Anti-Microbial TPR	260	6-5/16" (160)	4-55/64" (123)	Precision Ball	CH-05AMP-125-DL-____
5	1-1/4	Polyurethane TPU	260	6-5/16" (160)	4-55/64" (123)	Precision Ball	CH-05PYP-125-DL-____
6	1-1/4	Conductive Rubber	260	7-9/32" (185)	4-55/64" (123)	Annular Ball	CH-06CRB-125-DL-____
6	1-1/4	Thermoplastic Rubber	260	7-9/32" (185)	4-55/64" (123)	Precision Ball	CH-06TPP-125-DL-____
6	1-1/4	Anti-Microbial TPR	260	7-9/32" (185)	4-55/64" (123)	Precision Ball	CH-06AMP-125-DL-____
6	1-1/4	Polyurethane TPU	260	7-9/32" (185)	4-55/64" (123)	Precision Ball	CH-06PYP-125-DL-____



Direction Lock
Change "SW" to "DL". **Green** sticker on pedal.

ROUND STEM FITTINGS

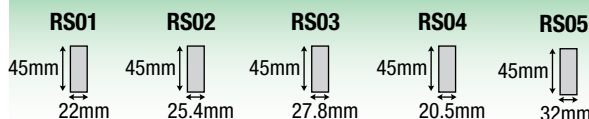

SQUARE STEM FITTINGS

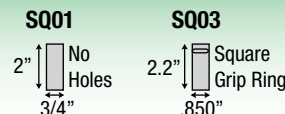

Specify Round Stem (RS) code, Square stem specify (SQ) code. see fittings at left for dimensions..

CHROME STEEL (CS)

SWIVEL TOP PLATE MODELS
 FREE SWIVEL • TOTAL LOCK • DIRECTION LOCK



- APPLICATIONS**
- Food Service
 - Case Carts
 - Utility Carts
 - Medical Equipment
 - Institutional Equipment
 - Hospital Carts
 - Pharmaceutical Equipment

- FEATURES**
- Dual Ball Swivel Raceways for added strength
 - **Total Lock Brake** models lock both swivel and wheel
 - Directional lock models lock swivel only (helps with Steering)
 - Wheels available with Precision ball bearings or spanner bushing
 - Wheels with Precision Bearings have Full Plastic thread guards for added protection
 - Bright Chrome Finish

Chrome Steel casters that look and meet the European standards.

SWIVEL TOP PLATE MODELS

Wheel Diameter inches (mm)	Tread Width (inches)	Wheel Description	Capacity (Lbs)	Load Height inches (mm)	Swivel Radius inches (mm)	Wheel Bearing	Model Number
4" (100)	1-1/4	Black Neoprene Rubber	190	5-1/2" (140)	3-15/32" (88)	Precision Ball	CS-04NRP-125-SW-TP01
4" (100)	1-1/4	Thermoplastic Rubber	190	5-1/2" (140)	3-15/32" (88)	Precision Ball	CS-04TPP-125-SW-TP01
4" (100)	1-1/4	Thermoplastic Rubber	190	5-1/2" (140)	3-15/32" (88)	Plain Bore	CS-04TPO-125-SW-TP01
5" (125)	1-1/4	Black Neoprene Rubber	220	6-1/2" (165)	4-3/32" (104)	Precision Ball	CS-05NRP-125-SW-TP01
5" (125)	1-1/4	Thermoplastic Rubber	220	6-1/2" (165)	4-3/32" (104)	Precision Ball	CS-05TPP-125-SW-TP01
5" (125)	1-1/4	Thermoplastic Rubber	220	6-1/2" (165)	4-3/32" (104)	Plain Bore	CS-05TPO-125-SW-TP01



TOP PLATE FITTING TP01

Swivel Top Plate Pattern

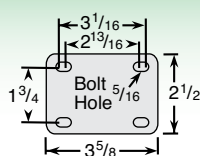

CHROME STEEL (CS)

SWIVEL TOP PLATE MODELS

FREE SWIVEL • TOTAL LOCK • DIRECTION LOCK

SWIVEL TOP PLATE TOTAL LOCK MODELS (WHEEL AND SWIVEL)

Wheel Diameter inches (mm)	Tread Width (inches)	Wheel Description	Capacity (lbs)	Load Height inches (mm)	Swivel Radius inches (mm)	Wheel Bearing	Model Number
4" (100)	1-1/4	Black Neoprene Rubber	190	5-1/2" (140)	5-3/8" (136)	Precision Ball	CS-04NRP-125-TL-TP01
4" (100)	1-1/4	Thermoplastic Rubber	190	5-1/2" (140)	5-3/8" (136)	Precision Ball	CS-04TPP-125-TL-TP01
4" (100)	1-1/4	Thermoplastic Rubber	190	5-1/2" (140)	5-3/8" (136)	Plain Bore	CS-04TPO-125-TL-TP01
5" (125)	1-1/4	Black Neoprene Rubber	220	6-1/2" (165)	5-3/8" (136)	Precision Ball	CS-05NRP-125-TL-TP01
5" (125)	1-1/4	Thermoplastic Rubber	220	6-1/2" (165)	5-3/8" (136)	Precision Ball	CS-05TPP-125-TL-TP01
5" (125)	1-1/4	Thermoplastic Rubber	220	6-1/2" (165)	5-3/8" (136)	Plain Bore	CS-05TPO-125-TL-TP01



"Brake" stamped on pedal.

SWIVEL TOP PLATE DIRECTION LOCK MODELS (SWIVEL ONLY)

Wheel Diameter inches (mm)	Tread Width (inches)	Wheel Description	Capacity (lbs)	Load Height inches (mm)	Swivel Radius inches (mm)	Wheel Bearing	Model Number
4" (100)	1-1/4	Black Neoprene Rubber	190	5-1/2" (140)	5-3/8" (136)	Precision Ball	CS-04NRP-125-DL-TP01
4" (100)	1-1/4	Thermoplastic Rubber	190	5-1/2" (140)	5-3/8" (136)	Precision Ball	CS-04TPP-125-DL-TP01
4" (100)	1-1/4	Thermoplastic Rubber	190	5-1/2" (140)	5-3/8" (136)	Plain Bore	CS-04TPO-125-DL-TP01
5" (125)	1-1/4	Black Neoprene Rubber	220	6-1/2" (165)	5-3/8" (136)	Precision Ball	CS-05NRP-125-DL-TP01
5" (125)	1-1/4	Thermoplastic Rubber	220	6-1/2" (165)	5-3/8" (136)	Precision Ball	CS-05TPP-125-DL-TP01
5" (125)	1-1/4	Thermoplastic Rubber	220	6-1/2" (165)	5-3/8" (136)	Plain Bore	CS-05TPO-125-DL-TP01



"Steer" stamped on pedal.

TOP PLATE FITTING TP01

Swivel Top
Plate Pattern

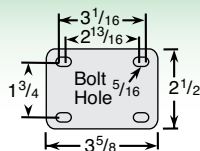

CHROME STEEL (CS)

HOLLOW KINGPIN MODELS
 FREE SWIVEL • TOTAL LOCK • DIRECTION LOCK



- APPLICATIONS**
- Food Service
 - Case Carts
 - Utility Carts
 - Medical Equipment
 - Institutional Equipment
 - Hospital Carts
 - Pharmaceutical Equipment

- FEATURES**
- Dual Ball Swivel Raceways for added strength
 - **Total Lock Brake** models lock both swivel and wheel
 - Directional lock models lock swivel only (helps with Steering)
 - Wheels available with Precision ball bearings or spanner bushing
 - Wheels with Precision Bearings have Full Plastic thread guards for added protection
 - Bright Chrome Finish

Chrome Steel casters that look and meet the European standards.

HOLLOW KINGPIN MODELS

Wheel Diameter inches (mm)	Tread Width (inches)	Wheel Description	Capacity (Lbs)	Load Height inches (mm)	Swivel Radius inches (mm)	Wheel Bearing	Model Number
4" (100)	1-1/4	Black Neoprene Rubber	190	5-5/16" (135)	3-15/32" (88)	Precision Ball	CS-04NRP-125-SW-HKU1
4" (100)	1-1/4	Thermoplastic Rubber	190	5-5/16" (135)	3-15/32" (88)	Precision Ball	CS-04TPP-125-SW-HKU1
4" (100)	1-1/4	Thermoplastic Rubber	190	5-5/16" (135)	3-15/32" (88)	Plain Bore	CS-04TPO-125-SW-HKU1
5" (125)	1-1/4	Black Neoprene Rubber	220	6-5/16" (160)	4-3/32" (104)	Precision Ball	CS-05NRP-125-SW-HKU1
5" (125)	1-1/4	Thermoplastic Rubber	220	6-5/16" (160)	4-3/32" (104)	Precision Ball	CS-05TPP-125-SW-HKU1
5" (125)	1-1/4	Thermoplastic Rubber	220	6-5/16" (160)	4-3/32" (104)	Plain Bore	CS-05TPO-125-SW-HKU1



HOLLOW KINGPIN

Caster is **provided unassembled** to make it easy to add your choice of fitting. If you would like these assembled change **HKU1** (shown at right) to **HK01** (assembled and shown above). 1/2 I.D.



CHROME STEEL (CS)

HOLLOW KINGPIN MODELS

FREE SWIVEL • TOTAL LOCK • DIRECTION LOCK

HOLLOW KINGPIN TOTAL LOCK MODELS (WHEEL AND SWIVEL)

Wheel Diameter inches (mm)	Tread Width (inches)	Wheel Description	Capacity (Lbs)	Load Height inches (mm)	Swivel Radius inches (mm)	Wheel Bearing	Model Number
4" (100)	1-1/4	Black Neoprene Rubber	190	5-5/16" (135)	5-3/8" (136)	Precision Ball	CS-04NRP-125-TL-HKU1
4" (100)	1-1/4	Thermoplastic Rubber	190	5-5/16" (135)	5-3/8" (136)	Precision Ball	CS-04TPP-125-TL-HKU1
4" (100)	1-1/4	Thermoplastic Rubber	190	5-5/16" (135)	5-3/8" (136)	Plain Bore	CS-04TPO-125-TL-HKU1
5" (125)	1-1/4	Black Neoprene Rubber	220	6-5/16" (160)	5-3/8" (136)	Precision Ball	CS-05NRP-125-TL-HKU1
5" (125)	1-1/4	Thermoplastic Rubber	220	6-5/16" (160)	5-3/8" (136)	Precision Ball	CS-05TPP-125-TL-HKU1
5" (125)	1-1/4	Thermoplastic Rubber	220	6-5/16" (160)	5-3/8" (136)	Plain Bore	CS-05TPO-125-TL-HKU1



"Brake" stamped on pedal.

HOLLOW KINGPIN DIRECTION LOCK MODELS (SWIVEL ONLY)

Wheel Diameter inches (mm)	Tread Width (inches)	Wheel Description	Capacity (Lbs)	Load Height inches (mm)	Swivel Radius inches (mm)	Wheel Bearing	Model Number
4" (100)	1-1/4	Black Neoprene Rubber	190	5-5/16" (135)	5-3/8" (136)	Precision Ball	CS-04NRP-125-DL-HKU1
4" (100)	1-1/4	Thermoplastic Rubber	190	5-5/16" (135)	5-3/8" (136)	Precision Ball	CS-04TPP-125-DL-HKU1
4" (100)	1-1/4	Thermoplastic Rubber	190	5-5/16" (135)	5-3/8" (136)	Plain Bore	CS-04TPO-125-DL-HKU1
5" (125)	1-1/4	Black Neoprene Rubber	220	6-5/16" (160)	5-3/8" (136)	Precision Ball	CS-05NRP-125-DL-HKU1
5" (125)	1-1/4	Thermoplastic Rubber	220	6-5/16" (160)	5-3/8" (136)	Precision Ball	CS-05TPP-125-DL-HKU1
5" (125)	1-1/4	Thermoplastic Rubber	220	6-5/16" (160)	5-3/8" (136)	Plain Bore	CS-05TPO-125-DL-HKU1



"Steer" stamped on pedal.

HOLLOW KINGPIN

Caster is **provided unassembled** to make it easy to add your choice of fitting. If you would like these assembled change **HKU1** (shown at right) to **HKO1** (assembled and shown above). 1/2 I.D.



CHROME STEEL (CS)

THREADED STEM MODELS
 FREE SWIVEL • TOTAL LOCK • DIRECTION LOCK



- APPLICATIONS**
- Food Service
 - Case Carts
 - Utility Carts
 - Medical Equipment
 - Institutional Equipment
 - Hospital Carts
 - Pharmaceutical Equipment

- FEATURES**
- Dual Ball Swivel Raceways for added strength
 - **Total Lock Brake** models lock both swivel and wheel
 - Directional lock models lock swivel only (helps with Steering)
 - Wheels available with Precision ball bearings or spanner bushing
 - Wheels with Precision Bearings have Full Plastic thread guards for added protection
 - Bright Chrome Finish

Chrome Steel casters that look and meet the European standards.

THREADED STEM MODELS

Wheel Diameter inches (mm)	Tread Width (inches)	Wheel Description	Capacity (Lbs)	Load Height inches (mm)	Swivel Radius inches (mm)	Wheel Bearing	Model Number
4" (100)	1-1/4	Neoprene Rubber	190	5-5/16" (135)	3-15/32" (88)	Precision Ball	CS-04NRP-125-SW-_____
4" (100)	1-1/4	Thermoplastic Rubber	190	5-5/16" (135)	3-15/32" (88)	Precision Ball	CS-04TPP-125-SW-_____
4" (100)	1-1/4	Thermoplastic Rubber	190	5-5/16" (135)	3-15/32" (88)	Plain Bore	CS-04TPO-125-SW-_____
5" (125)	1-1/4	Neoprene Rubber	220	6-5/16" (160)	4-3/32" (104)	Precision Ball	CS-05NRP-125-SW-_____
5" (125)	1-1/4	Thermoplastic Rubber	220	6-5/16" (160)	4-3/32" (104)	Precision Ball	CS-05TPP-125-SW-_____
5" (125)	1-1/4	Thermoplastic Rubber	220	6-5/16" (160)	4-3/32" (104)	Plain Bore	CS-05TPO-125-SW-_____



Specify Threaded Stem (TS) code, see fittings below for dimensions.

THREADED STEM FITTINGS

Easy to install stem. See fittings page for more options.

TS02

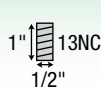

TS03

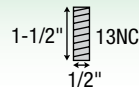

TS07



CHROME STEEL (CS)

THREADED STEM MODELS

FREE SWIVEL • TOTAL LOCK • DIRECTION LOCK

THREADED STEM TOTAL LOCK MODELS (WHEEL AND SWIVEL)

Wheel Diameter inches (mm)	Tread Width (inches)	Wheel Description	Capacity (Lbs)	Load Height inches (mm)	Swivel Radius inches (mm)	Wheel Bearing	Model Number
4" (100)	1-1/4	Neoprene Rubber	190	5-5/16" (135)	5-3/8" (136)	Precision Ball	CS-04NRP-125-TL-____
4" (100)	1-1/4	Thermoplastic Rubber	190	5-5/16" (135)	5-3/8" (136)	Precision Ball	CS-04TPP-125-TL-____
4" (100)	1-1/4	Thermoplastic Rubber	190	5-5/16" (135)	5-3/8" (136)	Plain Bore	CS-04TPO-125-TL-____
5" (125)	1-1/4	Neoprene Rubber	220	6-5/16" (160)	5-3/8" (136)	Precision Ball	CS-05NRP-125-TL-____
5" (125)	1-1/4	Thermoplastic Rubber	220	6-5/16" (160)	5-3/8" (136)	Precision Ball	CS-05TPP-125-TL-____
5" (125)	1-1/4	Thermoplastic Rubber	220	6-5/16" (160)	5-3/8" (136)	Plain Bore	CS-05TPO-125-TL-____



"Brake" stamped on pedal.

THREADED STEM DIRECTION LOCK MODELS (SWIVEL ONLY)

Wheel Diameter inches (mm)	Tread Width (inches)	Wheel Description	Capacity (Lbs)	Load Height inches (mm)	Swivel Radius inches (mm)	Wheel Bearing	Model Number
4" (100)	1-1/4	Neoprene Rubber	190	5-5/16" (135)	5-3/8" (136)	Precision Ball	CS-04NRP-125-DL-____
4" (100)	1-1/4	Thermoplastic Rubber	190	5-5/16" (135)	5-3/8" (136)	Precision Ball	CS-04TPP-125-DL-____
4" (100)	1-1/4	Thermoplastic Rubber	190	5-5/16" (135)	5-3/8" (136)	Plain Bore	CS-04TPO-125-DL-____
5" (125)	1-1/4	Neoprene Rubber	220	6-5/16" (160)	5-3/8" (136)	Precision Ball	CS-05NRP-125-DL-____
5" (125)	1-1/4	Thermoplastic Rubber	220	6-5/16" (160)	5-3/8" (136)	Precision Ball	CS-05TPP-125-DL-____
5" (125)	1-1/4	Thermoplastic Rubber	220	6-5/16" (160)	5-3/8" (136)	Plain Bore	CS-05TPO-125-DL-____



"Steer" stamped on pedal.

Specify Threaded Stem (TS) code, see fittings below for dimensions.

THREADED STEM FITTINGS

Easy to install stem. See fittings page for more options.

TS02

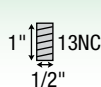

TS03

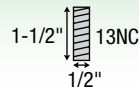

TS07



CHROME STEEL (CS)

GRIP RING STEM MODELS
 FREE SWIVEL • TOTAL LOCK • DIRECTION LOCK



- APPLICATIONS**
- Food Service
 - Case Carts
 - Utility Carts
 - Medical Equipment
 - Institutional Equipment
 - Hospital Carts
 - Pharmaceutical Equipment

- FEATURES**
- Dual Ball Swivel Raceways for added strength
 - **Total Lock Brake** models lock both swivel and wheel
 - Directional lock models lock swivel only (helps with Steering)
 - Wheels available with Precision ball bearings or spanner bushing
 - Wheels with Precision Bearings have Full Plastic thread guards for added protection
 - Bright Chrome Finish

Chrome Steel casters that look and meet the European standards.

GRIP RING STEM MODELS

Wheel Diameter inches (mm)	Tread Width (inches)	Wheel Description	Capacity (Lbs)	Load Height inches (mm)	Swivel Radius inches (mm)	Wheel Bearing	Model Number
4" (100)	1-1/4	Neoprene Rubber	190	5-5/16" (135)	3-15/32" (88)	Precision Ball	CS-04NRP-125-SW-
4" (100)	1-1/4	Thermoplastic Rubber	190	5-5/16" (135)	3-15/32" (88)	Precision Ball	CS-04TPP-125-SW-
4" (100)	1-1/4	Thermoplastic Rubber	190	5-5/16" (135)	3-15/32" (88)	Plain Bore	CS-04TPO-125-SW-
5" (125)	1-1/4	Neoprene Rubber	220	6-5/16" (160)	4-3/32" (104)	Precision Ball	CS-05NRP-125-SW-
5" (125)	1-1/4	Thermoplastic Rubber	220	6-5/16" (160)	4-3/32" (104)	Precision Ball	CS-05TPP-125-SW-
5" (125)	1-1/4	Thermoplastic Rubber	220	6-5/16" (160)	4-3/32" (104)	Plain Bore	CS-05TPO-125-SW-



Specify Grip Ring Stem (GR) code, see fittings below for dimensions.

GRIP RING STEM FITTINGS

Easy to install grip rings snap into place. See fittings page for more options.

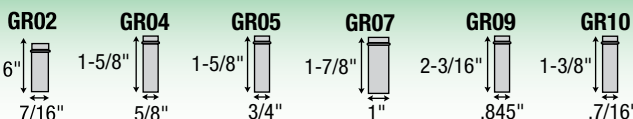

CHROME STEEL (CS)

GRIP RING STEM MODELS

FREE SWIVEL • TOTAL LOCK • DIRECTION LOCK

GRIP RING TOTAL LOCK MODELS (WHEEL AND SWIVEL)

Wheel Diameter inches (mm)	Tread Width (inches)	Wheel Description	Capacity (Lbs)	Load Height inches (mm)	Swivel Radius inches (mm)	Wheel Bearing	Model Number
4" (100)	1-1/4	Neoprene Rubber	190	5-5/16" (135)	5-3/8" (136)	Precision Ball	CS-04NRP-125-TL-____
4" (100)	1-1/4	Thermoplastic Rubber	190	5-5/16" (135)	5-3/8" (136)	Precision Ball	CS-04TPP-125-TL-____
4" (100)	1-1/4	Thermoplastic Rubber	190	5-5/16" (135)	5-3/8" (136)	Plain Bore	CS-04TPO-125-TL-____
5" (125)	1-1/4	Neoprene Rubber	220	6-5/16" (160)	5-3/8" (136)	Precision Ball	CS-05NRP-125-TL-____
5" (125)	1-1/4	Thermoplastic Rubber	220	6-5/16" (160)	5-3/8" (136)	Precision Ball	CS-05TPP-125-TL-____
5" (125)	1-1/4	Thermoplastic Rubber	220	6-5/16" (160)	5-3/8" (136)	Plain Bore	CS-05TPO-125-TL-____



"Brake" stamped on pedal.

GRIP RING DIRECTION LOCK MODELS (SWIVEL ONLY)

Wheel Diameter inches (mm)	Tread Width (inches)	Wheel Description	Capacity (Lbs)	Load Height inches (mm)	Swivel Radius inches (mm)	Wheel Bearing	Model Number
4" (100)	1-1/4	Neoprene Rubber	190	5-5/16" (135)	5-3/8" (136)	Precision Ball	CS-04NRP-125-DL-____
4" (100)	1-1/4	Thermoplastic Rubber	190	5-5/16" (135)	5-3/8" (136)	Precision Ball	CS-04TPP-125-DL-____
4" (100)	1-1/4	Thermoplastic Rubber	190	5-5/16" (135)	5-3/8" (136)	Plain Bore	CS-04TPO-125-DL-____
5" (125)	1-1/4	Neoprene Rubber	220	6-5/16" (160)	5-3/8" (136)	Precision Ball	CS-05NRP-125-DL-____
5" (125)	1-1/4	Thermoplastic Rubber	220	6-5/16" (160)	5-3/8" (136)	Precision Ball	CS-05TPP-125-DL-____
5" (125)	1-1/4	Thermoplastic Rubber	220	6-5/16" (160)	5-3/8" (136)	Plain Bore	CS-05TPO-125-DL-____



"Steer" stamped on pedal.

Specify Grip Ring Stem (GR) code, see fittings below for dimensions.

GRIP RING STEM FITTINGS

Easy to install grip rings snap into place. See fittings page for more options.

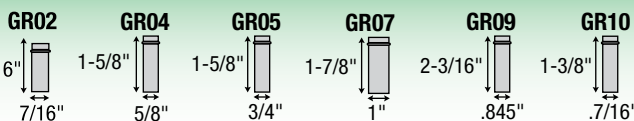

CHROME STEEL (CS)

ROUND/SQUARE STEM MODELS
 FREE SWIVEL • TOTAL LOCK • DIRECTION LOCK



- APPLICATIONS**
- Food Service
 - Case Carts
 - Utility Carts
 - Medical Equipment
 - Institutional Equipment
 - Hospital Carts
 - Pharmaceutical Equipment

- FEATURES**
- Dual Ball Swivel Raceways for added strength
 - **Total Lock Brake** models lock both swivel and wheel
 - Directional lock models lock swivel only (helps with Steering)
 - Wheels available with Precision ball bearings or spanner bushing
 - Wheels with Precision Bearings have Full Plastic thread guards for added protection
 - Bright Chrome Finish

Chrome Steel casters that look and meet the European standards.

ROUND/SQUARE STEM MODELS

Wheel Diameter inches (mm)	Tread Width (inches)	Wheel Description	Capacity (Lbs)	Load Height inches (mm)	Swivel Radius inches (mm)	Wheel Bearing	Model Number
4" (100)	1-1/4	Neoprene Rubber	190	5-5/16" (135)	3-15/32" (88)	Precision Ball	CS-04NRP-125-SW-
4" (100)	1-1/4	Thermoplastic Rubber	190	5-5/16" (135)	3-15/32" (88)	Precision Ball	CS-04TPP-125-SW-
4" (100)	1-1/4	Thermoplastic Rubber	190	5-5/16" (135)	3-15/32" (88)	Plain Bore	CS-04TPO-125-SW-
5" (125)	1-1/4	Neoprene Rubber	220	6-5/16" (160)	4-3/32" (104)	Precision Ball	CS-05NRP-125-SW-
5" (125)	1-1/4	Thermoplastic Rubber	220	6-5/16" (160)	4-3/32" (104)	Precision Ball	CS-05TPP-125-SW-
5" (125)	1-1/4	Thermoplastic Rubber	220	6-5/16" (160)	4-3/32" (104)	Plain Bore	CS-05TPO-125-SW-



Specify Round Stem (RS) code, or Square Stem (SQ) code. See fittings below for dimensions.

ROUND STEM FITTINGS

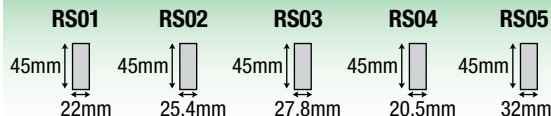

SQUARE STEM FITTINGS



See fittings page for more options.

CHROME STEEL (CS)

ROUND/SQUARE TOTAL LOCK MODELS (WHEEL AND SWIVEL)

Wheel Diameter inches (mm)	Tread Width (inches)	Wheel Description	Capacity (Lbs)	Load Height inches (mm)	Swivel Radius inches (mm)	Wheel Bearing	Model Number
4" (100)	1-1/4	Neoprene Rubber	190	5-5/16" (135)	5-3/8" (136)	Precision Ball	CS-04NRP-125-TL-___
4" (100)	1-1/4	Thermoplastic Rubber	190	5-5/16" (135)	5-3/8" (136)	Precision Ball	CS-04TPP-125-TL-___
4" (100)	1-1/4	Thermoplastic Rubber	190	5-5/16" (135)	5-3/8" (136)	Plain Bore	CS-04TPO-125-TL-___
5" (125)	1-1/4	Neoprene Rubber	220	6-5/16" (160)	5-3/8" (136)	Precision Ball	CS-05NRP-125-TL-___
5" (125)	1-1/4	Thermoplastic Rubber	220	6-5/16" (160)	5-3/8" (136)	Precision Ball	CS-05TPP-125-TL-___
5" (125)	1-1/4	Thermoplastic Rubber	220	6-5/16" (160)	5-3/8" (136)	Plain Bore	CS-05TPO-125-TL-___



"Brake" stamped on pedal.

ROUND/SQUARE DIRECTION LOCK MODELS (SWIVEL ONLY)

Wheel Diameter inches (mm)	Tread Width (inches)	Wheel Description	Capacity (Lbs)	Load Height inches (mm)	Swivel Radius inches (mm)	Wheel Bearing	Model Number
4" (100)	1-1/4	Neoprene Rubber	190	5-5/16" (135)	5-3/8" (136)	Precision Ball	CS-04NRP-125-DL-___
4" (100)	1-1/4	Thermoplastic Rubber	190	5-5/16" (135)	5-3/8" (136)	Precision Ball	CS-04TPP-125-DL-___
4" (100)	1-1/4	Thermoplastic Rubber	190	5-5/16" (135)	5-3/8" (136)	Plain Bore	CS-04TPO-125-DL-___
5" (125)	1-1/4	Neoprene Rubber	220	6-5/16" (160)	5-3/8" (136)	Precision Ball	CS-05NRP-125-DL-___
5" (125)	1-1/4	Thermoplastic Rubber	220	6-5/16" (160)	5-3/8" (136)	Precision Ball	CS-05TPP-125-DL-___
5" (125)	1-1/4	Thermoplastic Rubber	220	6-5/16" (160)	5-3/8" (136)	Plain Bore	CS-05TPO-125-DL-___
5" (125)	1-1/4	Polyurethane TPU	220	6-5/16" (160)	5-3/8" (136)	Precision Ball	CS-05PYP-125-DL-___



"Steer" stamped on pedal.

Specify Round Stem (RS) code, or Square Stem (SQ) code. See fittings below for dimensions.

ROUND STEM FITTINGS

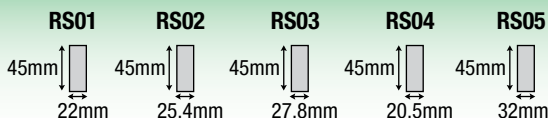

SQUARE STEM FITTINGS



See fittings page for more options.

STAINLESS STEEL (SS)

TOP PLATE MODELS

FREE SWIVEL • TOTAL LOCK • DIRECTION LOCK
1-1/4 TREAD WIDTH



- APPLICATIONS**
- Food Service
 - Case Carts
 - Utility Carts
 - Medical Equipment
 - Institutional Equipment
 - Laboratory Equipment
 - Animal Cages
 - Pharmaceutical Equipment

- FEATURES**
- 304 Stainless Steel, Polished
 - Dual Ball Swivel Raceways for added strength
 - **Total Lock Brake** models lock both swivel and wheel
 - Directional lock models lock swivel only (helps with Steering)
 - Precision ball bearings in wheels for easier rollability
 - Wheels have full plastic thread guards for added protection
 - TPP and AMP wheels are crowned for easy rolling and turning

Our SS series design is constructed of stainless steel. This design gives you the quality necessary for most medical and pharmaceutical applications at an affordable price.

SWIVEL TOP PLATE MODELS

Wheel Diameter (Inches)	Tread Width (Inches)	Wheel Description	Capacity (Lbs)	Load Height Inches (mm)	Swivel Radius Inches (mm)	Wheel Bearing	Model Number
3	1-1/4	Conductive Rubber	165	4-7/16" (113)	2-29/32" (74)	Annular Ball	SS-03CRB-125-SW-TP01
3	1-1/4	Thermoplastic Rubber	165	4-7/16" (113)	2-29/32" (74)	Precision Ball	SS-03TPP-125-SW-TP01
3	1-1/4	Anti-Microbial TPR	165	4-7/16" (113)	2-29/32" (74)	Precision Ball	SS-03AMP-125-SW-TP01
3	1-1/4	Polyurethane TPU	165	4-7/16" (113)	2-29/32" (74)	Precision Ball	SS-03PYP-125-SW-TP01
4	1-1/4	Conductive Rubber	190	5-7/16" (138)	3-37/64" (91)	Annular Ball	SS-04CRB-125-SW-TP01
4	1-1/4	Thermoplastic Rubber	190	5-7/16" (138)	3-37/64" (91)	Precision Ball	SS-04TPP-125-SW-TP01
4	1-1/4	Anti-Microbial TPR	190	5-7/16" (138)	3-37/64" (91)	Precision Ball	SS-04AMP-125-SW-TP01
4	1-1/4	Polyurethane TPU	190	5-7/16" (138)	3-37/64" (91)	Precision Ball	SS-04PYP-125-SW-TP01
5	1-1/4	Conductive Rubber	220	6-7/16" (163)	4-7/32" (108)	Annular Ball	SS-05CRB-125-SW-TP01
5	1-1/4	Thermoplastic Rubber	220	6-7/16" (163)	4-7/32" (108)	Precision Ball	SS-05TPP-125-SW-TP01
5	1-1/4	Anti-Microbial TPR	220	6-7/16" (163)	4-7/32" (108)	Precision Ball	SS-05AMP-125-SW-TP01
5	1-1/4	Polyurethane TPU	220	6-7/16" (163)	4-7/32" (108)	Precision Ball	SS-05PYP-125-SW-TP01
6	1-1/4	Conductive Rubber	240	7-13/32" (188)	4-39/64 (117)	Annular Ball	SS-06CRB-125-SW-TP01
6	1-1/4	Thermoplastic Rubber	240	7-13/32" (188)	4-39/64 (117)	Precision Ball	SS-06TPP-125-SW-TP01
6	1-1/4	Anti-Microbial TPR	240	7-13/32" (188)	4-39/64 (117)	Precision Ball	SS-06AMP-125-SW-TP01
6	1-1/4	Polyurethane TPU	240	7-13/32" (188)	4-39/64 (117)	Precision Ball	SS-06PYP-125-SW-TP01



Rigid models available change "SW to "RG"

TOP PLATE FITTING

Swivel Top Plate Pattern

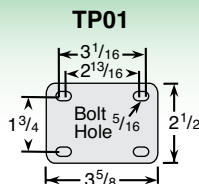

Anti-Microbial wheels have light green tread.



Stainless wheel bearings available. Change Bearing Code to "X" (Example : SS-03CRX-125-SW-TP01)

STAINLESS STEEL (SS)

SWIVEL TOP PLATE TOTAL LOCK MODELS (LOCKS WHEEL AND SWIVEL)

Wheel Diameter (Inches)	Tread Width (Inches)	Wheel Description	Capacity (Lbs)	Load Height Inches (mm)	Swivel Radius Inches (mm)	Wheel Bearing	Model Number
3	1-1/4	Conductive Rubber	165	4-7/16" (113)	4-1/4" (108)	Annular Ball	SS-03CRB-125-TL-TP01
3	1-1/4	Thermoplastic Rubber	165	4-7/16" (113)	4-1/4" (108)	Precision Ball	SS-03TPP-125-TL-TP01
3	1-1/4	Anti-Microbial TPR	165	4-7/16" (113)	4-1/4" (108)	Precision Ball	SS-03AMP-125-TL-TP01
3	1-1/4	Polyurethane TPU	165	4-7/16" (113)	4-1/4" (108)	Precision Ball	SS-03PYP-125-TL-TP01
4	1-1/4	Conductive Rubber	190	5-7/16" (138)	4-35/64" (115)	Annular Ball	SS-04CRB-125-TL-TP01
4	1-1/4	Thermoplastic Rubber	190	5-7/16" (138)	4-35/64" (115)	Precision Ball	SS-04TPP-125-TL-TP01
4	1-1/4	Anti-Microbial TPR	190	5-7/16" (138)	4-35/64" (115)	Precision Ball	SS-04AMP-125-TL-TP01
4	1-1/4	Polyurethane TPU	190	5-7/16" (138)	4-35/64" (115)	Precision Ball	SS-04PYP-125-TL-TP01
5	1-1/4	Conductive Rubber	220	6-7/16" (163)	4-55/64" (123)	Annular Ball	SS-05CRB-125-TL-TP01
5	1-1/4	Thermoplastic Rubber	220	6-7/16" (163)	4-55/64" (123)	Precision Ball	SS-05TPP-125-TL-TP01
5	1-1/4	Anti-Microbial TPR	220	6-7/16" (163)	4-55/64" (123)	Precision Ball	SS-05AMP-125-TL-TP01
5	1-1/4	Polyurethane TPU	220	6-7/16" (163)	4-55/64" (123)	Precision Ball	SS-05PYP-125-TL-TP01
6	1-1/4	Conductive Rubber	240	7-13/32" (188)	4-55/64" (123)	Annular Ball	SS-06CRB-125-TL-TP01
6	1-1/4	Thermoplastic Rubber	240	7-13/32" (188)	4-55/64" (123)	Precision Ball	SS-06TPP-125-TL-TP01
6	1-1/4	Anti-Microbial TPR	240	7-13/32" (188)	4-55/64" (123)	Precision Ball	SS-06AMP-125-TL-TP01
6	1-1/4	Polyurethane TPU	240	7-13/32" (188)	4-55/64" (123)	Precision Ball	SS-06PYP-125-TL-TP01



Total Lock
Change "SW" to "TL". **Red** sticker on pedal.

SWIVEL TOP PLATE DIRECTION LOCK MODELS (LOCKS SWIVEL ONLY)

Wheel Diameter (Inches)	Tread Width (Inches)	Wheel Description	Capacity (Lbs)	Load Height Inches (mm)	Swivel Radius Inches (mm)	Wheel Bearing	Model Number
3	1-1/4	Conductive Rubber	165	4-7/16" (113)	4-1/4" (108)	Annular Ball	SS-03CRB-125-DL-TP01
3	1-1/4	Thermoplastic Rubber	165	4-7/16" (113)	4-1/4" (108)	Precision Ball	SS-03TPP-125-DL-TP01
3	1-1/4	Anti-Microbial TPR	165	4-7/16" (113)	4-1/4" (108)	Precision Ball	SS-03AMP-125-DL-TP01
3	1-1/4	Polyurethane TPU	165	4-7/16" (113)	4-1/4" (108)	Precision Ball	SS-03PYP-125-DL-TP01
4	1-1/4	Conductive Rubber	190	5-7/16" (138)	4-35/64" (115)	Annular Ball	SS-04CRB-125-DL-TP01
4	1-1/4	Thermoplastic Rubber	190	5-7/16" (138)	4-35/64" (115)	Precision Ball	SS-04TPP-125-DL-TP01
4	1-1/4	Anti-Microbial TPR	190	5-7/16" (138)	4-35/64" (115)	Precision Ball	SS-04AMP-125-DL-TP01
4	1-1/4	Polyurethane TPU	190	5-7/16" (138)	4-35/64" (115)	Precision Ball	SS-04PYP-125-DL-TP01
5	1-1/4	Conductive Rubber	220	6-7/16" (163)	4-55/64" (123)	Annular Ball	SS-05CRB-125-DL-TP01
5	1-1/4	Thermoplastic Rubber	220	6-7/16" (163)	4-55/64" (123)	Precision Ball	SS-05TPP-125-DL-TP01
5	1-1/4	Anti-Microbial TPR	220	6-7/16" (163)	4-55/64" (123)	Precision Ball	SS-05AMP-125-DL-TP01
5	1-1/4	Polyurethane TPU	220	6-7/16" (163)	4-55/64" (123)	Precision Ball	SS-05PYP-125-DL-TP01
6	1-1/4	Conductive Rubber	240	7-13/32" (188)	4-55/64" (123)	Annular Ball	SS-06CRB-125-DL-TP01
6	1-1/4	Thermoplastic Rubber	240	7-13/32" (188)	4-55/64" (123)	Precision Ball	SS-06TPP-125-DL-TP01
6	1-1/4	Anti-Microbial TPR	240	7-13/32" (188)	4-55/64" (123)	Precision Ball	SS-06AMP-125-DL-TP01
6	1-1/4	Polyurethane TPU	240	7-13/32" (188)	4-55/64" (123)	Precision Ball	SS-06PYP-125-DL-TP01



Direction Lock
Change "SW" to "DL". **Green** sticker on pedal.

TOP PLATE FITTING

Swivel Top Plate Pattern

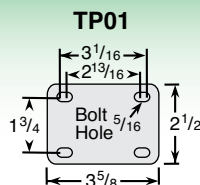

Stainless wheel bearings available. Change Bearing Code to "X" (Example : SS-03CRX-125-SW-TP01)

STAINLESS STEEL (SS)

HOLLOW KINGPIN MODELS
 FREE SWIVEL • TOTAL LOCK • DIRECTION LOCK
 1-1/4 TREAD WIDTH



- APPLICATIONS**
- Food Service
 - Case Carts
 - Utility Carts
 - Medical Equipment
 - Institutional Equipment
 - Laboratory Equipment
 - Animal Cages
 - Pharmaceutical Equipment

- FEATURES**
- 304 Stainless Steel, Polished
 - Dual Ball Swivel Raceways for added strength
 - **Total Lock Brake** models lock both swivel and wheel
 - Directional lock models lock swivel only (helps with Steering)
 - Precision ball bearings in wheels for easier rollability
 - Wheels have full plastic thread guards for added protection
 - TPP and AMP wheels are crowned for easy rolling and turning

Our SS series design is constructed of stainless steel. This design gives you the quality necessary for most medical and pharmaceutical applications at an affordable price.

HOLLOW KINGPIN MODELS

Wheel Diameter (Inches)	Tread Width (Inches)	Wheel Description	Capacity (Lbs)	Load Height Inches (mm)	Swivel Radius Inches (mm)	Wheel Bearing	Model Number
3	1-1/4	Conductive Rubber	165	4-5/16" (109)	2-29/32" (74)	Annular Ball	SS-03CRB-125-SW-HKU1
3	1-1/4	Thermoplastic Rubber	165	4-5/16" (109)	2-29/32" (74)	Precision Ball	SS-03TPP-125-SW-HKU1
3	1-1/4	Anti-Microbial TPR	165	4-5/16" (109)	2-29/32" (74)	Precision Ball	SS-03AMP-125-SW-HKU1
3	1-1/4	Polyurethane TPU	165	4-5/16" (109)	2-29/32" (74)	Precision Ball	SS-03PYP-125-SW-HKU1
4	1-1/4	Conductive Rubber	190	5-5/16" (135)	3-37/64" (91)	Annular Ball	SS-04CRB-125-SW-HKU1
4	1-1/4	Thermoplastic Rubber	190	5-5/16" (135)	3-37/64" (91)	Precision Ball	SS-04TPP-125-SW-HKU1
4	1-1/4	Anti-Microbial TPR	190	5-5/16" (135)	3-37/64" (91)	Precision Ball	SS-04AMP-125-SW-HKU1
4	1-1/4	Polyurethane TPU	190	5-5/16" (135)	3-37/64" (91)	Precision Ball	SS-04PYP-125-SW-HKU1
5	1-1/4	Conductive Rubber	220	6-5/16" (160)	4-7/32" (108)	Annular Ball	SS-05CRB-125-SW-HKU1
5	1-1/4	Thermoplastic Rubber	220	6-5/16" (160)	4-7/32" (108)	Precision Ball	SS-05TPP-125-SW-HKU1
5	1-1/4	Anti-Microbial TPR	220	6-5/16" (160)	4-7/32" (108)	Precision Ball	SS-05AMP-125-SW-HKU1
5	1-1/4	Polyurethane TPU	220	6-5/16" (160)	4-7/32" (108)	Precision Ball	SS-05PYP-125-SW-HKU1
6	1-1/4	Conductive Rubber	240	7-9/32" (185)	4-39/64 (117)	Annular Ball	SS-06CRB-125-SW-HKU1
6	1-1/4	Thermoplastic Rubber	240	7-9/32" (185)	4-39/64 (117)	Precision Ball	SS-06TPP-125-SW-HKU1
6	1-1/4	Anti-Microbial TPR	240	7-9/32" (185)	4-39/64 (117)	Precision Ball	SS-06AMP-125-SW-HKU1
6	1-1/4	Polyurethane TPU	240	7-9/32" (185)	4-39/64 (117)	Precision Ball	SS-06PYP-125-SW-HKU1



HOLLOW KINGPIN

Caster is **provided unassembled** to make it easy to add your choice of fitting. If you would like these assembled change **HKU1** to **HK01**. 1/2 I.D.



Anti-Microbial wheels have light green tread.



Stainless wheel bearings available. Change Bearing Code to "X" (Example : SS-03CRX-125-SW-___)

STAINLESS STEEL (SS)

HOLLOW KINGPIN TOTAL LOCK MODELS (LOCKS WHEEL AND SWIVEL)

Wheel Diameter (Inches)	Tread Width (Inches)	Wheel Description	Capacity (Lbs)	Load Height Inches (mm)	Swivel Radius Inches (mm)	Wheel Bearing	Model Number
3	1-1/4	Conductive Rubber	165	4-5/16" (109)	4-1/4" (108)	Annular Ball	SS-03CRB-125-TL-HKU1
3	1-1/4	Thermoplastic Rubber	165	4-5/16" (109)	4-1/4" (108)	Precision Ball	SS-03TPP-125-TL-HKU1
3	1-1/4	Anti-Microbial TPR	165	4-5/16" (109)	4-1/4" (108)	Precision Ball	SS-03AMP-125-TL-HKU1
3	1-1/4	Polyurethane TPU	165	4-5/16" (109)	4-1/4" (108)	Precision Ball	SS-03PYP-125-TL-HKU1
4	1-1/4	Conductive Rubber	190	5-5/16" (135)	4-35/64" (115)	Annular Ball	SS-04CRB-125-TL-HKU1
4	1-1/4	Thermoplastic Rubber	190	5-5/16" (135)	4-35/64" (115)	Precision Ball	SS-04TPP-125-TL-HKU1
4	1-1/4	Anti-Microbial TPR	190	5-5/16" (135)	4-35/64" (115)	Precision Ball	SS-04AMP-125-TL-HKU1
4	1-1/4	Polyurethane TPU	190	5-5/16" (135)	4-35/64" (115)	Precision Ball	SS-04PYP-125-TL-HKU1
5	1-1/4	Conductive Rubber	220	6-5/16" (160)	4-55/64" (123)	Annular Ball	SS-05CRB-125-TL-HKU1
5	1-1/4	Thermoplastic Rubber	220	6-5/16" (160)	4-55/64" (123)	Precision Ball	SS-05TPP-125-TL-HKU1
5	1-1/4	Anti-Microbial TPR	220	6-5/16" (160)	4-55/64" (123)	Precision Ball	SS-05AMP-125-TL-HKU1
5	1-1/4	Polyurethane TPU	220	6-5/16" (160)	4-55/64" (123)	Precision Ball	SS-05PYP-125-TL-HKU1
6	1-1/4	Conductive Rubber	240	7-9/32" (185)	4-55/64" (123)	Annular Ball	SS-06CRB-125-TL-HKU1
6	1-1/4	Thermoplastic Rubber	240	7-9/32" (185)	4-55/64" (123)	Precision Ball	SS-06TPP-125-TL-HKU1
6	1-1/4	Anti-Microbial TPR	240	7-9/32" (185)	4-55/64" (123)	Precision Ball	SS-06AMP-125-TL-HKU1
6	1-1/4	Polyurethane TPU	240	7-9/32" (185)	4-55/64" (123)	Precision Ball	SS-06PYP-125-TL-HKU1



Total Lock
Change "SW"
to "TL". **Red**
sticker on pedal.

HOLLOW KINGPIN DIRECTION LOCK MODELS (LOCKS SWIVEL ONLY)

Wheel Diameter (Inches)	Tread Width (Inches)	Wheel Description	Capacity (Lbs)	Load Height Inches (mm)	Swivel Radius Inches (mm)	Wheel Bearing	Model Number
3	1-1/4	Conductive Rubber	165	4-5/16" (109)	4-1/4" (108)	Annular Ball	SS-03CRB-125-DL-HKU1
3	1-1/4	Thermoplastic Rubber	165	4-5/16" (109)	4-1/4" (108)	Precision Ball	SS-03TPP-125-DL-HKU1
3	1-1/4	Anti-Microbial TPR	165	4-5/16" (109)	4-1/4" (108)	Precision Ball	SS-03AMP-125-DL-HKU1
3	1-1/4	Polyurethane TPU	165	4-5/16" (109)	4-1/4" (108)	Precision Ball	SS-03PYP-125-DL-HKU1
4	1-1/4	Conductive Rubber	190	5-5/16" (135)	4-35/64" (115)	Annular Ball	SS-04CRB-125-DL-HKU1
4	1-1/4	Thermoplastic Rubber	190	5-5/16" (135)	4-35/64" (115)	Precision Ball	SS-04TPP-125-DL-HKU1
4	1-1/4	Anti-Microbial TPR	190	5-5/16" (135)	4-35/64" (115)	Precision Ball	SS-04AMP-125-DL-HKU1
4	1-1/4	Polyurethane TPU	190	5-5/16" (135)	4-35/64" (115)	Precision Ball	SS-04PYP-125-DL-HKU1
5	1-1/4	Conductive Rubber	220	6-5/16" (160)	4-55/64" (123)	Annular Ball	SS-05CRB-125-DL-HKU1
5	1-1/4	Thermoplastic Rubber	220	6-5/16" (160)	4-55/64" (123)	Precision Ball	SS-05TPP-125-DL-HKU1
5	1-1/4	Anti-Microbial TPR	220	6-5/16" (160)	4-55/64" (123)	Precision Ball	SS-05AMP-125-DL-HKU1
5	1-1/4	Polyurethane TPU	220	6-5/16" (160)	4-55/64" (123)	Precision Ball	SS-05PYP-125-DL-HKU1
6	1-1/4	Conductive Rubber	240	7-9/32" (185)	4-55/64" (123)	Annular Ball	SS-06CRB-125-DL-HKU1
6	1-1/4	Thermoplastic Rubber	240	7-9/32" (185)	4-55/64" (123)	Precision Ball	SS-06TPP-125-DL-HKU1
6	1-1/4	Anti-Microbial TPR	240	7-9/32" (185)	4-55/64" (123)	Precision Ball	SS-06AMP-125-DL-HKU1
6	1-1/4	Polyurethane TPU	240	7-9/32" (185)	4-55/64" (123)	Precision Ball	SS-06PYP-125-DL-HKU1



Direction Lock
Change "SW"
to "DL". **Green**
sticker on pedal.

HOLLOW KINGPIN

Caster is **provided unassembled** to make it easy to add your choice of fitting. If you would like these assembled change **HKU1** to **HK01**. 1/2 I.D.



Stainless wheel bearings available. Change Bearing Code to "X" (Example : SS-03CRX-125-SW-___)

STAINLESS STEEL (SS)

THREADED STEM MODELS

FREE SWIVEL • TOTAL LOCK • DIRECTION LOCK
1-1/4 TREAD WIDTH



- APPLICATIONS**
- Food Service
 - Case Carts
 - Utility Carts
 - Medical Equipment
 - Institutional Equipment
 - Laboratory Equipment
 - Animal Cages
 - Pharmaceutical Equipment

- FEATURES**
- 304 Stainless Steel, Polished
 - Dual Ball Swivel Raceways for added strength
 - **Total Lock Brake** models lock both swivel and wheel
 - Directional lock models lock swivel only (helps with Steering)
 - Precision ball bearings in wheels for easier rollability
 - Wheels have full plastic thread guards for added protection
 - TPP and AMP wheels are crowned for easy rolling and turning

Our SS series design is constructed of stainless steel. This design gives you the quality necessary for most medical and pharmaceutical applications at an affordable price.

THREADED STEM MODELS

Wheel Diameter (Inches)	Tread Width (Inches)	Wheel Description	Capacity (Lbs)	Load Height Inches (mm)	Swivel Radius Inches (mm)	Wheel Bearing	Model Number
3	1-1/4	Conductive Rubber	165	4-5/16" (109)	2-29/32" (74)	Annular Ball	SS-03CRB-125-SW-____
3	1-1/4	Thermoplastic Rubber	165	4-5/16" (109)	2-29/32" (74)	Precision Ball	SS-03TPP-125-SW-____
3	1-1/4	Anti-Microbial TPR	165	4-5/16" (109)	2-29/32" (74)	Precision Ball	SS-03AMP-125-SW-____
3	1-1/4	Polyurethane TPU	165	4-5/16" (109)	2-29/32" (74)	Precision Ball	SS-03PYP-125-SW-____
4	1-1/4	Conductive Rubber	190	5-5/16" (135)	3-37/64" (91)	Annular Ball	SS-04CRB-125-SW-____
4	1-1/4	Thermoplastic Rubber	190	5-5/16" (135)	3-37/64" (91)	Precision Ball	SS-04TPP-125-SW-____
4	1-1/4	Anti-Microbial TPR	190	5-5/16" (135)	3-37/64" (91)	Precision Ball	SS-04AMP-125-SW-____
4	1-1/4	Polyurethane TPU	190	5-5/16" (135)	3-37/64" (91)	Precision Ball	SS-04PYP-125-SW-____
5	1-1/4	Conductive Rubber	220	6-5/16" (160)	4-7/32" (108)	Annular Ball	SS-05CRB-125-SW-____
5	1-1/4	Thermoplastic Rubber	220	6-5/16" (160)	4-7/32" (108)	Precision Ball	SS-05TPP-125-SW-____
5	1-1/4	Anti-Microbial TPR	220	6-5/16" (160)	4-7/32" (108)	Precision Ball	SS-05AMP-125-SW-____
5	1-1/4	Polyurethane TPU	220	6-5/16" (160)	4-7/32" (108)	Precision Ball	SS-05PYP-125-SW-____
6	1-1/4	Conductive Rubber	240	7-9/32" (185)	4-39/64 (117)	Annular Ball	SS-06CRB-125-SW-____
6	1-1/4	Thermoplastic Rubber	240	7-9/32" (185)	4-39/64 (117)	Precision Ball	SS-06TPP-125-SW-____
6	1-1/4	Anti-Microbial TPR	240	7-9/32" (185)	4-39/64 (117)	Precision Ball	SS-06AMP-125-SW-____
6	1-1/4	Polyurethane TPU	240	7-9/32" (185)	4-39/64 (117)	Precision Ball	SS-06PYP-125-SW-____



Anti-Microbial wheels have light green tread.



THREADED STEM FITTINGS

See fittings page for more options.

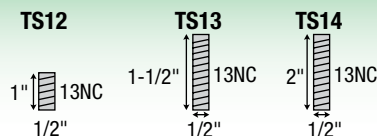

Specify Threaded Stem (TS) code, see fittings at left for dimensions.

Round and square stems available, please consult factory. Stainless wheel bearings available. Change Bearing Code to "X" (Example : SS-03CRX-125-SW-____)

STAINLESS STEEL (SS)

THREADED STEM TOTAL LOCK MODELS (LOCKS WHEEL AND SWIVEL)

Wheel Diameter (Inches)	Tread Width (Inches)	Wheel Description	Capacity (Lbs)	Load Height Inches (mm)	Swivel Radius Inches (mm)	Wheel Bearing	Model Number
3	1-1/4	Conductive Rubber	165	4-5/16" (109)	4-1/4" (108)	Annular Ball	SS-03CRB-125-TL-____
3	1-1/4	Thermoplastic Rubber	165	4-5/16" (109)	4-1/4" (108)	Precision Ball	SS-03TPP-125-TL-____
3	1-1/4	Anti-Microbial TPR	165	4-5/16" (109)	4-1/4" (108)	Precision Ball	SS-03AMP-125-TL-____
3	1-1/4	Polyurethane TPU	165	4-5/16" (109)	4-1/4" (108)	Precision Ball	SS-03PYP-125-TL-____
4	1-1/4	Conductive Rubber	190	5-5/16" (135)	4-35/64" (115)	Annular Ball	SS-04CRB-125-TL-____
4	1-1/4	Thermoplastic Rubber	190	5-5/16" (135)	4-35/64" (115)	Precision Ball	SS-04TPP-125-TL-____
4	1-1/4	Anti-Microbial TPR	190	5-5/16" (135)	4-35/64" (115)	Precision Ball	SS-04AMP-125-TL-____
4	1-1/4	Polyurethane TPU	190	5-5/16" (135)	4-35/64" (115)	Precision Ball	SS-04PYP-125-TL-____
5	1-1/4	Conductive Rubber	220	6-5/16" (160)	4-55/64" (123)	Annular Ball	SS-05CRB-125-TL-____
5	1-1/4	Thermoplastic Rubber	220	6-5/16" (160)	4-55/64" (123)	Precision Ball	SS-05TPP-125-TL-____
5	1-1/4	Anti-Microbial TPR	220	6-5/16" (160)	4-55/64" (123)	Precision Ball	SS-05AMP-125-TL-____
5	1-1/4	Polyurethane TPU	220	6-5/16" (160)	4-55/64" (123)	Precision Ball	SS-05PYP-125-TL-____
6	1-1/4	Conductive Rubber	240	7-9/32" (185)	4-55/64" (123)	Annular Ball	SS-06CRB-125-TL-____
6	1-1/4	Thermoplastic Rubber	240	7-9/32" (185)	4-55/64" (123)	Precision Ball	SS-06TPP-125-TL-____
6	1-1/4	Anti-Microbial TPR	240	7-9/32" (185)	4-55/64" (123)	Precision Ball	SS-06AMP-125-TL-____
6	1-1/4	Polyurethane TPU	240	7-9/32" (185)	4-55/64" (123)	Precision Ball	SS-06PYP-125-TL-____



Total Lock
Change "SW"
to "TL". Red
sticker on pedal.

THREADED STEM DIRECTION LOCK MODELS (LOCKS SWIVEL ONLY)

Wheel Diameter (Inches)	Tread Width (Inches)	Wheel Description	Capacity (Lbs)	Load Height Inches (mm)	Swivel Radius Inches (mm)	Wheel Bearing	Model Number
3	1-1/4	Conductive Rubber	165	4-5/16" (109)	4-1/4" (108)	Annular Ball	SS-03CRB-125-DL-____
3	1-1/4	Thermoplastic Rubber	165	4-5/16" (109)	4-1/4" (108)	Precision Ball	SS-03TPP-125-DL-____
3	1-1/4	Anti-Microbial TPR	165	4-5/16" (109)	4-1/4" (108)	Precision Ball	SS-03AMP-125-DL-____
3	1-1/4	Polyurethane TPU	165	4-5/16" (109)	4-1/4" (108)	Precision Ball	SS-03PYP-125-DL-____
4	1-1/4	Conductive Rubber	190	5-5/16" (135)	4-35/64" (115)	Annular Ball	SS-04CRB-125-DL-____
4	1-1/4	Thermoplastic Rubber	190	5-5/16" (135)	4-35/64" (115)	Precision Ball	SS-04TPP-125-DL-____
4	1-1/4	Anti-Microbial TPR	190	5-5/16" (135)	4-35/64" (115)	Precision Ball	SS-04AMP-125-DL-____
4	1-1/4	Polyurethane TPU	190	5-5/16" (135)	4-35/64" (115)	Precision Ball	SS-04PYP-125-DL-____
5	1-1/4	Conductive Rubber	220	6-5/16" (160)	4-55/64" (123)	Annular Ball	SS-05CRB-125-DL-____
5	1-1/4	Thermoplastic Rubber	220	6-5/16" (160)	4-55/64" (123)	Precision Ball	SS-05TPP-125-DL-____
5	1-1/4	Anti-Microbial TPR	220	6-5/16" (160)	4-55/64" (123)	Precision Ball	SS-05AMP-125-DL-____
5	1-1/4	Polyurethane TPU	220	6-5/16" (160)	4-55/64" (123)	Precision Ball	SS-05PYP-125-DL-____
6	1-1/4	Conductive Rubber	240	7-9/32" (185)	4-55/64" (123)	Annular Ball	SS-06CRB-125-DL-____
6	1-1/4	Thermoplastic Rubber	240	7-9/32" (185)	4-55/64" (123)	Precision Ball	SS-06TPP-125-DL-____
6	1-1/4	Anti-Microbial TPR	240	7-9/32" (185)	4-55/64" (123)	Precision Ball	SS-06AMP-125-DL-____
6	1-1/4	Polyurethane TPU	240	7-9/32" (185)	4-55/64" (123)	Precision Ball	SS-06PYP-125-DL-____



Direction Lock
Change "SW"
to "DL". Green
sticker on pedal.

THREADED STEM FITTINGS

See fittings page for more options.

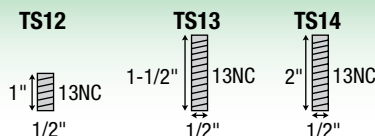

Specify Threaded Stem (TS) code, see fittings at left for dimensions.

Round and square stems available, please consult factory.
Stainless wheel bearings available. Change Bearing Code to "X" (Example : SS-03CRX-125-SW-____)

STAINLESS STEEL (SS)

TOP PLATE MODELS
 FREE SWIVEL • TOTAL LOCK
 2" TREAD WIDTH



New Total Lock brake design – locks both brake and swivel.

- APPLICATIONS**
- Food Service
 - Case Carts
 - Utility Carts
 - Medical Equipment
 - Institutional Equipment
 - Laboratory Equipment
 - Animal Cages
 - Pharmaceutical Equipment

- FEATURES**
- Fork legs, top plate and yoke base are made of 1/4" thick 304 polished stainless steel for added corrosion protection
 - **Total Lock brake** models lock both brake and swivel
 - Dual Ball Swivel Raceways for added strength
 - Swivel seals are standard for added protection
 - Stainless axles provided with grease fitting
 - Grease fitting in swivel raceway

Our SS series design is constructed of stainless steel. This design gives you the quality necessary for most medical and pharmaceutical applications at an affordable price.

NEW Eagle Polyurethane wheels now available



TOP PLATE FITTING

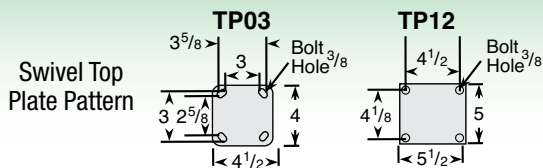

STAINLESS STEEL SIDE LOCK BRAKE

Wheel Diameter	Kit Number
4"	SS04200
5"	SS05200
6"	SS06200
8"	SS08200



To order field installable kit specify kit number. To order on caster change fork code from "SW" to "TB"

(Example: SS-06PSR-200-TB-TP03)

STAINLESS STEEL (SS)

TOP PLATE MODELS

Wheel Diameter (Inches)	Tread Width (Inches)	Wheel Description	Capacity (Lbs)	Load Height (Inches)	Swivel Radius (Inches)	Wheel Bearing	Model Number
4	2	White Polyolefin	550	5-5/8	3-3/8	Delrin	SS-04PWD-200-SW-TP03
4	2	White Polyolefin	550	5-5/8	3-3/8	Roller	SS-04PWR-200-SW-TP03
4	2	Polyurethane Eagle	600	5-5/8	3-3/8	Delrin	SS-04EPD-200-SW-TP03
4	2	Polyurethane Eagle	600	5-5/8	3-3/8	Roller	SS-04EPR-200-SW-TP03
4	2	Nylon	800	5-5/8	3-3/8	Delrin	SS-04NYD-200-SW-TP03
4	2	Nylon	800	5-5/8	3-3/8	Roller	SS-04NYR-200-SW-TP03
4	2	Polyurethane Solid	800	5-5/8	3-3/8	Roller	SS-04PSR-200-SW-TP03
4	2	Polyurethane Solid	800	5-5/8	3-3/8	Delrin	SS-04PSD-200-SW-TP03
5	2	White Polyolefin	650	6-1/2	4-1/8	Delrin	SS-05PWD-200-SW-TP03
5	2	White Polyolefin	650	6-1/2	4-1/8	Roller	SS-05PWR-200-SW-TP03
5	2	Polyurethane Eagle	900	6-1/2	4-1/8	Delrin	SS-05EPD-200-SW-TP03
5	2	Polyurethane Eagle	900	6-1/2	4-1/8	Roller	SS-05EPR-200-SW-TP03
5	2	Nylon	900	6-1/2	4-1/8	Roller	SS-05NYR-200-SW-TP03
5	2	Nylon	900	6-1/2	4-1/8	Delrin	SS-05NYD-200-SW-TP03
5	2	Polyurethane Solid	900	6-1/2	4-1/8	Roller	SS-05PSR-200-SW-TP03
5	2	Polyurethane Solid	900	6-1/2	4-1/8	Delrin	SS-05PSD-200-SW-TP03
6	2	White Polyolefin	700	7-1/2	4-3/4	Delrin	SS-06PWD-200-SW-TP03
6	2	White Polyolefin	700	7-1/2	4-3/4	Roller	SS-06PWR-200-SW-TP03
6	2	Nylon	900	7-1/2	4-3/4	Roller	SS-06NYR-200-SW-TP03
6	2	Nylon	900	7-1/2	4-3/4	Delrin	SS-06NYD-200-SW-TP03
6	2	Polyurethane Solid	900	7-1/2	4-3/4	Roller	SS-06PSR-200-SW-TP03
6	2	Polyurethane Solid	900	7-1/2	4-3/4	Delrin	SS-06PSD-200-SW-TP03
6	2	Polyurethane Eagle	1000	7-1/2	4-3/4	Delrin	SS-06EPD-200-SW-TP03
6	2	Polyurethane Eagle	1000	7-1/2	4-3/4	Roller	SS-06EPR-200-SW-TP03
8	2	White Polyolefin	800	9-1/2	5-3/4	Delrin	SS-08PWD-200-SW-TP03
8	2	White Polyolefin	800	9-1/2	5-3/4	Roller	SS-08PWR-200-SW-TP03
8	2	Nylon	900	9-1/2	5-3/4	Roller	SS-08NYR-200-SW-TP03
8	2	Nylon	900	9-1/2	5-3/4	Delrin	SS-08NYD-200-SW-TP03
8	2	Polyurethane Solid	900	9-1/2	5-3/4	Roller	SS-08PSR-200-SW-TP03
8	2	Polyurethane Solid	900	9-1/2	5-3/4	Delrin	SS-08PSD-200-SW-TP03
8	2	Polyurethane Eagle	1000	9-1/2	5-3/4	Delrin	SS-08EPD-200-SW-TP03
8	2	Polyurethane Eagle	1000	9-1/2	5-3/4	Roller	SS-08EPR-200-SW-TP03



Stainless Steel Roller Bearings available, change bearing designation to S, example SS-08PWS200-SW-TP03.
 Stainless Steel Precision Bearings available on some models, please consult factory.
 Other bearings also available, please consult factory.
 Stainless wheel brakes are available for swivel models, Change SW to TB.
 Rigid models are available, change SW to RG.

Stainless Steel **Total Lock** brake available for swivel models, change SW to TL.

TOP PLATE FITTING

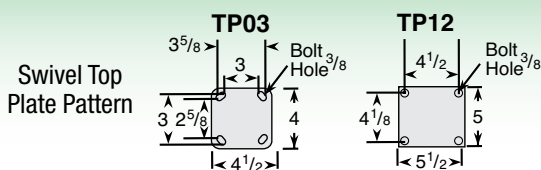

Total Lock Swivel Lead/Swivel Radius

Part Number	Swivel Lead	Swivel Radius
SS04200TL-TP03	34.0 mm	150.6 mm
SS05200TL-TP03	38.2 mm	160.5 mm
SS06200TL-TP03	44.3 mm	170.8 mm
SS08200TL-TP03	56.0 mm	193.5 mm



AUTOCLAVE (AC)

TOP PLATE MODELS

FREE SWIVEL • RIGID • TOP LOCK BRAKE

NEW



- APPLICATIONS**
- Food Service
 - Case Carts
 - Utility Carts
 - Medical Equipment
 - Institutional Equipment
 - Laboratory Equipment
 - Animal Cages
 - Pharmaceutical Equipment

- FEATURES**
- 304 Stainless Steel, Polished
 - Dual Ball Swivel Raceways for added strength
 - High temp swivel seals are standard
 - Stainless steel zerk fittings in swivel raceway
 - Stainless steel precision ball or rollerbearings in wheels for easier rollability
 - Wheels have plastic thread guards for added protection

Our AC series is constructed of quality 304 stainless steel. Caster is specially designed for many different medical and pharmaceutical applications such as autoclavable applications.

SWIVEL TOP PLATE MODELS

Wheel Diameter (Inches)	Tread Width (Inches)	Wheel Description	Capacity (Lbs)	Load Height Inches (mm)	Swivel Radius Inches (mm)	Wheel Bearing	Model Number
4	1-1/4	Hytrel on Autoclaveable PP	275	5-7/16	3-37/64	Stainless Precision Ball	AC-04HSP-125-SW-____
4	1-1/4	MedEagle Polyurethane	275	5-7/16	3-37/64	Stainless Roller	AC-04EPR-125-SW-____
4	1-1/4	Hi- Temp Phenolic	275	5-7/16	3-37/64	Stainless Roller	AC-04PHR-125-SW-____
5	1-1/4	Hytrel on Autoclaveable PP	300	6-7/16	4-7/32	Stainless Precision Ball	AC-05HSP-125-SW-____
5	1-1/4	MedEagle Polyurethane	300	6-7/16	4-7/32	Stainless Roller	AC-05EPR-125-SW-____
5	1-1/4	Hi- Temp Phenolic	300	6-7/16	4-7/32	Stainless Roller	AC-05PHR-125-SW-____
6	1-1/4	Hytrel on Autoclaveable PP	325	7-13/32	4-39/64	Stainless Precision Ball	AC-06HSP-125-SW-____
6	1-1/4	MedEagle Polyurethane	325	7-13/32	4-39/64	Stainless Roller	AC-06EPR-125-SW-____
6	1-1/4	Hi- Temp Phenolic	325	7-13/32	4-39/64	Stainless Roller	AC-06PHR-125-SW-____

Temperature Range

Hytrel wheel....250°F intermittingly
 Eagle wheel....230°F intermittingly
 Hi temp phenolic....300°F continuous

Specify fitting code, see fittings at left for dimensions.

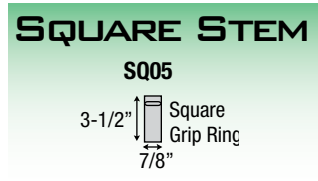
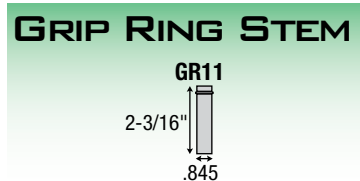
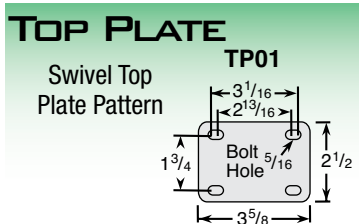

AUTOCLAVE (AC)

RIGID TOP PLATE MODELS

Wheel Diameter (Inches)	Tread Width (Inches)	Wheel Description	Capacity (Lbs)	Load Height Inches (mm)	Swivel Radius Inches (mm)	Wheel Bearing	Model Number
4	1-1/4	Hytrel on Autoclavealble PP	275	5-7/16	N/A	Stainless Precision Ball	AC-04HSP-125-RG-____
4	1-1/4	MedEagle Polyurethane	275	5-7/16	N/A	Stainless Roller	AC-04EPR-125-RG-____
4	1-1/4	HI- Temp Phenolic	275	5-7/16	N/A	Stainless Roller	AC-04PHR-125-RG-____
5	1-1/4	Hytrel on Autoclavealble PP	300	6-7/16	N/A	Stainless Precision Ball	AC-05HSP-125-RG-____
5	1-1/4	MedEagle Polyurethane	300	6-7/16	N/A	Stainless Roller	AC-05EPR-125-RG-____
5	1-1/4	HI- Temp Phenolic	300	6-7/16	N/A	Stainless Roller	AC-05PHR-125-RG-____
6	1-1/4	Hytrel on Autoclavealble PP	325	7-13/32	N/A	Stainless Precision Ball	AC-06HSP-125-RG-____
6	1-1/4	MedEagle Polyurethane	325	7-13/32	N/A	Stainless Roller	AC-06EPR-125-RG-____
6	1-1/4	HI- Temp Phenolic	325	7-13/32	N/A	Stainless Roller	AC-06PHR-125-RG-____

SWIVEL TOP PLATE MODELS WITH TOP LOCK BRAKE

Wheel Diameter (Inches)	Tread Width (Inches)	Wheel Description	Capacity (Lbs)	Load Height Inches (mm)	Swivel Radius Inches (mm)	Wheel Bearing	Model Number
4	1-1/4	Hytrel on Autoclavealble PP	275	5-7/16	3-37/64	Stainless Precision Ball	AC-04HSP-125-TB-____
4	1-1/4	MedEagle Polyurethane	275	5-7/16	3-37/64	Stainless Roller	AC-04EPR-125-TB-____
4	1-1/4	HI- Temp Phenolic	275	5-7/16	3-37/64	Stainless Roller	AC-04PHR-125-TB-____
5	1-1/4	Hytrel on Autoclavealble PP	300	6-7/16	4-7/32	Stainless Precision Ball	AC-05HSP-125-TB-____
5	1-1/4	MedEagle Polyurethane	300	6-7/16	4-7/32	Stainless Roller	AC-05EPR-125-TB-____
5	1-1/4	HI- Temp Phenolic	300	6-7/16	4-7/32	Stainless Roller	AC-05PHR-125-TB-____
6	1-1/4	Hytrel on Autoclavealble PP	325	7-13/32	4-39/64	Stainless Precision Ball	AC-06HSP-125-TB-____
6	1-1/4	MedEagle Polyurethane	325	7-13/32	4-39/64	Stainless Roller	AC-06EPR-125-TB-____
6	1-1/4	HI- Temp Phenolic	325	7-13/32	4-39/64	Stainless Roller	AC-06PHR-125-TB-____

Specify fitting code, see fittings at left for dimensions.

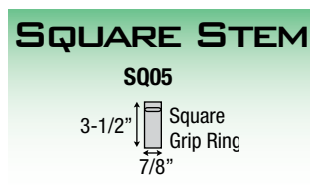
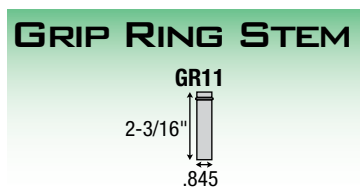
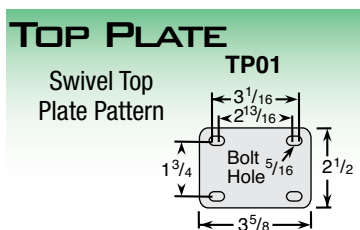

"NG" Next Generation

NYLON CASTERS - THE INSIDE STORY



3" thru 6" wheel diameters available.

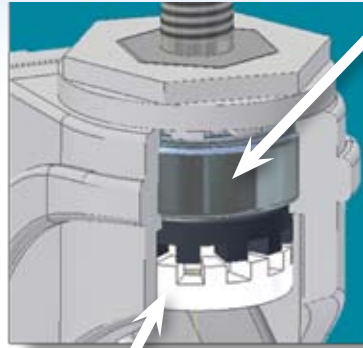

Direction and Total Lock braking action designed into caster.

NG series has precision sealed ball bearing raceway design for long lasting, smooth, quiet, maintenance free ride. Precision ball bearings are insert molded into the swivel raceway. Caster capacity is similar to steel wheels at a massive 325 lbs with 5" wheel.

PERFORMANCE FEATURES

- QUIET
- CLEAN
- SMOOTH
- MAINTENANCE FREE
- HIGHER CAPACITY



Custom Colors Available

Glass filled nylon for added strength and durability. Custom colors available.

Sealed precision ball bearing is insert molded into the swivel raceway.

Wheels feature sealed precision ball bearings to provide a smooth, quiet and maintenance free ride.

Recessed nut and bolt axles with covers allow for easy wheel replacement.

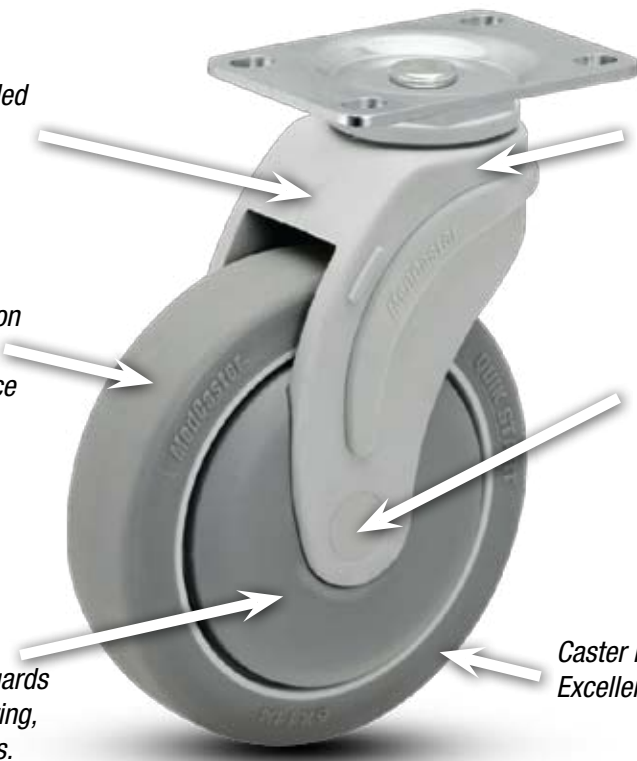

Fully Integrated thread guards prevent the pick-up of string, sutures and foreign debris.

Caster is resistant to most chemicals. Excellent for wash down applications.

NG NEXT GENERATION



Page 58-69

NG RIGID BRAKE



Page 58-69

NS STAINLESS



Page 70-77

NA ANTISTATIC



Page 94-95

NG ANTIMICROBIAL



Page 58-69

NEW! MQ MARQUE NYLON CASTERS (NQ)



Page
78-83

- APPLICATIONS**
- Food Service Equipment
 - Case Carts
 - Utility Carts
 - Medical Equipment
 - Institutional Equipment
 - Hospital Carts
 - Animal Cage Carts
 - Pharmaceutical Equipment

- FEATURES**
- Glass filled nylon body
 - Dual ball bearing raceway
 - Total lock and direction lock brake models available
 - Resistant to water and most chemicals
 - Precision bearing in wheel
 - Zinc plated top plate
 - Riveted axle



Custom Colors Available

PLASTIC SERIES CASTERS



PG
Page
84-91



PA Antistatic
Page
78-83

NEXT GENERATION NYLON (NG)

TOP PLATE MODELS

FREE SWIVEL • TOTAL LOCK • DIRECTION LOCK



- APPLICATIONS**
- Food Service Equipment
 - Case Carts
 - Utility Carts
 - Medical Equipment
 - Institutional Equipment
 - Hospital Carts
 - Animal Cage Carts

- FEATURES**
- Maintenance free
 - Sealed precision bearing raceway, smooth and quiet
 - **Total Lock Brake** models lock both swivel and wheel
 - Directional lock models lock swivel only (helps with steering)
 - Wheels feature sealed precision ball bearings and full thread guards
 - Resistance to most chemicals
 - Zinc plated top plate
 - Recessed axle with plastic cap covers



Custom Colors Available



Precision sealed ball bearing raceway design for smooth, quiet maintenance free ride.

Our NG series is made of glass filled nylon for added strength and durability. Precision ball bearings are insert molded into the swivel raceway.

SWIVEL TOP PLATE MODELS

Precision sealed ball bearing raceway design for smooth, quiet maintenance free ride.

Wheel Diameter (Inches)	Tread Width (Inches)	Wheel Description	Capacity (Lbs)	Load Height Inches (mm)	Swivel Radius Inches (mm)	Wheel Bearing	Model Number
3	1-1/4	QuikStart TPR	200	4-1/4" (108)	2-13/16" (72)	Precision Ball	NG-03QDP-125-SW-TP01
3	1-1/4	QuikStart TPR	200	4-1/4" (108)	2-13/16" (72)	Plain	NG-03QDO-125-SW-TP01
3	1-1/4	Anti-Microbial TPR	200	4-1/4" (108)	2-13/16" (72)	Precision Ball	NG-03AMP-125-SW-TP01
4	1-1/4	QuikStart TPR	275	5-3/4" (146)	3-7/16" (87)	Precision Ball	NG-04QDP-125-SW-TP01
4	1-1/4	Anti-Microbial TPR	275	5-3/4" (146)	3-7/16" (87)	Precision Ball	NG-04AMP-125-SW-TP01
5	1-1/4	Santoprene	260	6-7/8" (174)	4" (102)	Precision Ball	NG-05RPP-125-SW-TP01
5	1-1/4	QuikStart TPR	325	6-7/8" (174)	4" (102)	Precision Ball	NG-05QDP-125-SW-TP01
5	1-1/4	Anti-Microbial TPR	325	6-7/8" (174)	4" (102)	Precision Ball	NG-05AMP-125-SW-TP01
6	1-1/4	QuikStart TPR	325	7-11/16" (195)	4-9/16" (116)	Precision Ball	NG-06QDP-125-SW-TP01
6	1-1/4	QuikStart TPR	325	7-11/16" (195)	4-9/16" (116)	Plain	NG-06QDO-125-SW-TP01
6	1-1/4	Anti-Microbial TPR	325	7-11/16" (195)	4-9/16" (116)	Precision Ball	NG-06AMP-125-SW-TP01



Note: Antimicrobial casters (AMP) wheels have the darker grey fork and brighter wheel.

NEW New 5" diameter crowned tread Santoprene models now available.

NEW Rigid model available for 5" and 6" diameter wheels. 3" model coming soon. Change SW to RG.

TOP PLATE FITTING

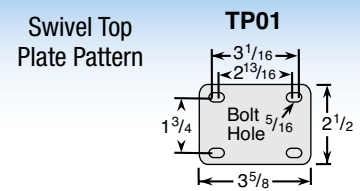

NEXT GENERATION NYLON (NG)

TOP PLATE MODELS

FREE SWIVEL • TOTAL LOCK • DIRECTION LOCK

SWIVEL TOP PLATE TOTAL LOCK MODELS

(LOCKS WHEEL AND SWIVEL)

Precision sealed ball bearing raceway design for smooth, quiet maintenance free ride.

Wheel Diameter (Inches)	Tread Width (Inches)	Wheel Description	Capacity (lbs)	Load Height Inches (mm)	Swivel Radius Inches (mm)	Wheel Bearing	Model Number
3	1-1/4	QuikStart TPR	200	4-1/4" (108)	3-3/4" (95)	Precision Ball	NG-03QDP-125-TL-TP01
3	1-1/4	QuikStart TPR	200	4-1/4" (108)	3-3/4" (95)	Plain	NG-03QDO-125-TL-TP01
3	1-1/4	Anti-Microbial TPR	200	4-1/4" (108)	3-3/4" (95)	Precision Ball	NG-03AMP-125-TL-TP01
4	1-1/4	QuikStart TPR	275	5-3/4" (146)	4-7/16" (112)	Precision Ball	NG-04QDP-125-TL-TP01
4	1-1/4	Anti-Microbial TPR	275	5-3/4" (146)	4-7/16" (112)	Precision Ball	NG-04AMP-125-TL-TP01
5	1-1/4	Santoprene	260	6-7/8" (174)	4-7/16" (112)	Precision Ball	NG-05RPP-125-TL-TP01
5	1-1/4	QuikStart TPR	325	6-7/8" (174)	4-7/16" (112)	Precision Ball	NG-05QDP-125-TL-TP01
5	1-1/4	Anti-Microbial TPR	325	6-7/8" (174)	4-7/16" (112)	Precision Ball	NG-05AMP-125-TL-TP01
6	1-1/4	QuikStart TPR	325	7-11/16" (195)	4-9/16" (116)	Precision Ball	NG-06QDP-125-TL-TP01
6	1-1/4	QuikStart TPR	325	7-11/16" (195)	4-9/16" (116)	Plain	NG-06QDO-125-TL-TP01
6	1-1/4	Anti-Microbial TPR	325	7-11/16" (195)	4-9/16" (116)	Precision Ball	NG-06AMP-125-TL-TP01



SWIVEL TOP PLATE DIRECTION LOCK MODELS

(LOCKS SWIVEL ONLY)

Precision sealed ball bearing raceway design for smooth, quiet maintenance free ride.

Wheel Diameter (Inches)	Tread Width (Inches)	Wheel Description	Capacity (lbs)	Load Height Inches (mm)	Swivel Radius Inches (mm)	Wheel Bearing	Model Number
3	1-1/4	QuikStart TPR	200	4-1/4" (108)	3-3/4" (95)	Precision Ball	NG-03QDP-125-DL-TP01
3	1-1/4	QuikStart TPR	200	4-1/4" (108)	3-3/4" (95)	Plain	NG-03QDO-125-DL-TP01
3	1-1/4	Anti-Microbial TPR	200	4-1/4" (108)	3-3/4" (95)	Precision Ball	NG-03AMP-125-DL-TP01
4	1-1/4	QuikStart TPR	275	5-3/4" (146)	4-7/16" (112)	Precision Ball	NG-04QDP-125-DL-TP01
4	1-1/4	Anti-Microbial TPR	275	5-3/4" (146)	4-7/16" (112)	Precision Ball	NG-04AMP-125-DL-TP01
5	1-1/4	Santoprene	260	6-7/8" (174)	4-7/16" (112)	Precision Ball	NG-05RPP-125-DL-TP01
5	1-1/4	QuikStart TPR	325	6-7/8" (174)	4-7/16" (112)	Precision Ball	NG-05QDP-125-DL-TP01
5	1-1/4	Anti-Microbial TPR	325	6-7/8" (174)	4-7/16" (112)	Precision Ball	NG-05AMP-125-DL-TP01
6	1-1/4	QuikStart TPR	325	7-11/16" (195)	4-9/16" (116)	Precision Ball	NG-06QDP-125-DL-TP01
6	1-1/4	QuikStart TPR	325	7-11/16" (195)	4-9/16" (116)	Plain	NG-06QDO-125-DL-TP01
6	1-1/4	Anti-Microbial TPR	325	7-11/16" (195)	4-9/16" (116)	Precision Ball	NG-06AMP-125-DL-TP01



Our Directional Lock casters are designed to lock the swivel but not the wheel allowing you to steer your equipment. The directional lock feature is designed to break free under heavier load when the unit is traversing a corner only to lock back into position when the unit resumes a straight course.

TOP PLATE FITTING

Swivel Top Plate Pattern

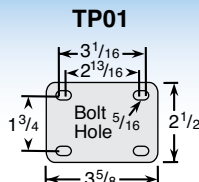

New rigid brake models now available on 5" models. Change TL to RB

NEXT GENERATION NYLON (NG)

HOLLOW KINGPIN MODELS
FREE SWIVEL • TOTAL LOCK • DIRECTION LOCK



- APPLICATIONS**
- Food Service Equipment
 - Case Carts
 - Utility Carts
 - Medical Equipment
 - Institutional Equipment
 - Hospital Carts
 - Animal Cage Carts



Custom Colors Available



Precision sealed ball bearing raceway design for smooth, quiet maintenance free ride.

- FEATURES**
- Maintenance free
 - Sealed precision bearing raceway, smooth and quiet
 - **Total Lock Brake** models lock both swivel and wheel
 - Directional lock models lock swivel only (helps with steering)
 - Wheels feature sealed precision ball bearings and full thread guards
 - Resistance to most chemicals
 - Zinc plated top plate
 - Recessed axle with plastic cap covers

Our NG series is made of glass filled nylon for added strength and durability. Precision ball bearings are insert molded into the swivel raceway.

HOLLOW KINGPIN MODELS

Precision sealed ball bearing raceway design for smooth, quiet maintenance free ride.

Wheel Diameter (Inches)	Tread Width (Inches)	Wheel Description	Capacity (Lbs)	Load Height Inches (mm)	Swivel Radius Inches (mm)	Wheel Bearing	Model Number
3	1-1/4	QuikStart TPR	200	4-7/32" (107)	2-13/16" (72)	Precision Ball	NG-03QDP-125-SW-HKU4
3	1-1/4	QuikStart TPR	200	4-7/32" (107)	2-13/16" (72)	Plain	NG-03QDO-125-SW-HKU4
3	1-1/4	Anti-Microbial TPR	200	4-7/32" (107)	2-13/16" (72)	Precision Ball	NG-03AMP-125-SW-HKU4
4	1-1/4	QuikStart TPR	275	5-13/32" (137)	3-7/16" (87)	Precision Ball	NG-04QDP-125-SW-HKU1
4	1-1/4	Anti-Microbial TPR	275	5-13/32" (137)	3-7/16" (87)	Precision Ball	NG-04AMP-125-SW-HKU1
5	1-1/4	Santoprene	260	6-1/2" (165)	4" (102)	Precision Ball	NG-05RPP-125-SW-HKU1
5	1-1/4	QuikStart TPR	325	6-1/2" (165)	4" (102)	Precision Ball	NG-05QDP-125-SW-HKU1
5	1-1/4	Anti-Microbial TPR	325	6-1/2" (165)	4" (102)	Precision Ball	NG-05AMP-125-SW-HKU1
6	1-1/4	QuikStart TPR	325	7-1/2" (191)	4-9/16" (116)	Precision Ball	NG-06QDP-125-SW-HKU1
6	1-1/4	QuikStart TPR	325	7-1/2" (191)	4-9/16" (116)	Plain	NG-06QDO-125-SW-HKU1
6	1-1/4	Anti-Microbial TPR	325	7-1/2" (191)	4-9/16" (116)	Precision Ball	NG-06AMP-125-SW-HKU1



Note: Antimicrobial casters (AMP) wheels have the darker grey fork and brighter wheel.

NEW



New 5" diameter crowned tread Santoprene models now available.

NEW



Rigid model available for 5" and 6" diameter wheels. 3" model coming soon. Change SW to RG.

HOLLOW KINGPIN

Caster is **provided unassembled** to make it easy to add your choice of fitting. If you would like these assembled change **HKU4** to **HK04** on 3" diameter models, Change **HKU1** to **HK01** on 4" to 6" diameter models. 3/8" I.D. on 3" diam. models; 1/2" I.D. on 4", 5", & 6" diam. models.



NEXT GENERATION NYLON (NG)

HOLLOW KINGPIN MODELS
FREE SWIVEL • TOTAL LOCK • DIRECTION LOCK

HOLLOW KINGPIN TOTAL LOCK MODELS

(LOCKS WHEEL AND SWIVEL)

Precision sealed ball bearing raceway design for smooth, quiet maintenance free ride.

Wheel Diameter (Inches)	Tread Width (Inches)	Wheel Description	Capacity (lbs)	Load Height Inches (mm)	Swivel Radius Inches (mm)	Wheel Bearing	Model Number
3	1-1/4	QuikStart TPR	200	4-7/32" (107)	3-3/4" (95)	Precision Ball	NG-03QDP-125-TL-HKU4
3	1-1/4	QuikStart TPR	200	4-7/32" (107)	3-3/4" (95)	Plain	NG-03QDO-125-TL-HKU4
3	1-1/4	Anti-Microbial TPR	200	4-7/32" (107)	3-3/4" (95)	Precision Ball	NG-03AMP-125-TL-HKU4
4	1-1/4	QuikStart TPR	275	5-13/32" (137)	4-7/16" (112)	Precision Ball	NG-04QDP-125-TL-HKU1
4	1-1/4	Anti-Microbial TPR	275	5-13/32" (137)	4-7/16" (112)	Precision Ball	NG-04AMP-125-TL-HKU1
5	1-1/4	Santoprene	260	6-1/2" (165)	4-7/16" (112)	Precision Ball	NG-05RPP-125-TL-HKU1
5	1-1/4	QuikStart TPR	325	6-1/2" (165)	4-7/16" (112)	Precision Ball	NG-05QDP-125-TL-HKU1
5	1-1/4	Anti-Microbial TPR	325	6-1/2" (165)	4-7/16" (112)	Precision Ball	NG-05AMP-125-TL-HKU1
6	1-1/4	QuikStart TPR	325	7-1/2" (191)	4-9/16" (116)	Precision Ball	NG-06QDP-125-TL-HKU1
6	1-1/4	QuikStart TPR	325	7-1/2" (191)	4-9/16" (116)	Plain	NG-06QDO-125-TL-HKU1
6	1-1/4	Anti-Microbial TPR	325	7-1/2" (191)	4-9/16" (116)	Precision Ball	NG-06AMP-125-TL-HKU1



HOLLOW KINGPIN DIRECTION LOCK MODELS

(LOCKS SWIVEL ONLY)

Precision sealed ball bearing raceway design for smooth, quiet maintenance free ride.

Wheel Diameter (Inches)	Tread Width (Inches)	Wheel Description	Capacity (lbs)	Load Height Inches (mm)	Swivel Radius Inches (mm)	Wheel Bearing	Model Number
3	1-1/4	QuikStart TPR	200	4-7/32" (107)	3-3/4" (95)	Precision Ball	NG-03QDP-125-DL-HKU4
3	1-1/4	QuikStart TPR	200	4-7/32" (107)	3-3/4" (95)	Plain	NG-03QDO-125-DL-HKU4
3	1-1/4	Anti-Microbial TPR	200	4-7/32" (107)	3-3/4" (95)	Precision Ball	NG-03AMP-125-DL-HKU4
4	1-1/4	QuikStart TPR	275	5-13/32" (137)	4-7/16" (112)	Precision Ball	NG-04QDP-125-DL-HKU1
4	1-1/4	Anti-Microbial TPR	275	5-13/32" (137)	4-7/16" (112)	Precision Ball	NG-04AMP-125-DL-HKU1
5	1-1/4	Santoprene	260	6-1/2" (165)	4-7/16" (112)	Precision Ball	NG-05RPP-125-DL-HKU1
5	1-1/4	QuikStart TPR	325	6-1/2" (165)	4-7/16" (112)	Precision Ball	NG-05QDP-125-DL-HKU1
5	1-1/4	Anti-Microbial TPR	325	6-1/2" (165)	4-7/16" (112)	Precision Ball	NG-05AMP-125-DL-HKU1
6	1-1/4	QuikStart TPR	325	7-1/2" (191)	4-9/16" (116)	Precision Ball	NG-06QDP-125-DL-HKU1
6	1-1/4	QuikStart TPR	325	7-1/2" (191)	4-9/16" (116)	Plain	NG-06QDO-125-DL-HKU1
6	1-1/4	Anti-Microbial TPR	325	7-1/2" (191)	4-9/16" (116)	Precision Ball	NG-06AMP-125-DL-HKU1



Our Directional Lock casters are designed to lock the swivel but not the wheel allowing you to steer your equipment. The directional lock feature is designed to break free under heavier load when the unit is traversing a corner only to lock back into position when the unit resumes a straight course.



New rigid brake models now available on 5" models. Change TL to RB

HOLLOW KINGPIN

Caster is **provided unassembled** to make it easy to add your choice of fitting. If you would like these assembled change **HKU4** to **HK04** on 3" diameter models, Change **HKU1** to **HK01** on 4" to 6" diameter models. 3/8" I.D. on 3" diam. models; 1/2" I.D. on 4", 5", & 6" diam. models.



NEXT GENERATION NYLON (NG)

GRIP RING STEM MODELS
FREE SWIVEL • TOTAL LOCK • DIRECTION LOCK



- APPLICATIONS**
- Food Service Equipment
 - Case Carts
 - Utility Carts
 - Medical Equipment
 - Institutional Equipment
 - Hospital Carts
 - Animal Cage Carts



Custom Colors Available



Precision sealed ball bearing raceway design for smooth, quiet maintenance free ride.

- FEATURES**
- Maintenance free
 - Sealed precision bearing raceway, smooth and quiet
 - **Total Lock Brake** models lock both swivel and wheel
 - Directional lock models lock swivel only (helps with steering)
 - Wheels feature sealed precision ball bearings and full thread guards
 - Resistance to most chemicals
 - Zinc plated top plate
 - Recessed axle with plastic cap covers

Our NG series is made of glass filled nylon for added strength and durability. Precision ball bearings are insert molded into the swivel raceway.

GRIP RING STEM MODELS

Precision sealed ball bearing raceway design for smooth, quiet maintenance free ride.

Wheel Diameter (Inches)	Tread Width (Inches)	Wheel Description	Capacity (Lbs)	Load Height Inches (mm)	Swivel Radius Inches (mm)	Wheel Bearing	Model Number
3	1-1/4	QuikStart TPR	200	4-7/32" (107)	2-13/16" (72)	Precision Ball	NG-03QDP-125-SW-_____
3	1-1/4	QuikStart TPR	200	4-7/32" (107)	2-13/16" (72)	Plain	NG-03QDO-125-SW-_____
3	1-1/4	Anti-Microbial TPR	200	4-7/32" (107)	2-13/16" (72)	Precision Ball	NG-03AMP-125-SW-_____
4	1-1/4	QuikStart TPR	275	5-13/32" (137)	3-7/16" (87)	Precision Ball	NG-04QDP-125-SW-_____
4	1-1/4	Anti-Microbial TPR	275	5-13/32" (137)	3-7/16" (87)	Precision Ball	NG-04AMP-125-SW-_____
5	1-1/4	Santoprene	260	6-1/2" (165)	4" (102)	Precision Ball	NG-05RPP-125-SW-_____
5	1-1/4	QuikStart TPR	325	6-1/2" (165)	4" (102)	Precision Ball	NG-05QDP-125-SW-_____
5	1-1/4	Anti-Microbial TPR	325	6-1/2" (165)	4" (102)	Precision Ball	NG-05AMP-125-SW-_____
6	1-1/4	QuikStart TPR	325	7-1/2" (191)	4-9/16" (116)	Precision Ball	NG-06QDP-125-SW-_____
6	1-1/4	QuikStart TPR	325	7-1/2" (191)	4-9/16" (116)	Plain	NG-06QDO-125-SW-_____
6	1-1/4	Anti-Microbial TPR	325	7-1/2" (191)	4-9/16" (116)	Precision Ball	NG-06AMP-125-SW-_____



Note: Antimicrobial casters (AMP) wheels have the the darker grey fork and brighter wheel.

NEW



New 5" diameter crowned tread Santoprene models now available.

Specify Grip Ring Stem (GR) code, see fittings below for dimensions.

GRIP RING STEM FITTINGS

See fittings page for more options.

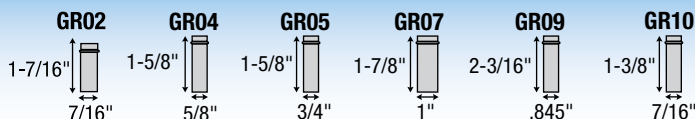

NEXT GENERATION NYLON (NG)

GRIP RING STEM MODELS

FREE SWIVEL • TOTAL LOCK • DIRECTION LOCK

GRIP RING STEM TOTAL LOCK MODELS

(LOCKS WHEEL AND SWIVEL)

Precision sealed ball bearing raceway design for smooth, quiet maintenance free ride.

Wheel Diameter (Inches)	Tread Width (Inches)	Wheel Description	Capacity (lbs)	Load Height Inches (mm)	Swivel Radius Inches (mm)	Wheel Bearing	Model Number
3	1-1/4	QuikStart TPR	200	4-7/32" (107)	3-3/4" (95)	Precision Ball	NG-03QDP-125-TL-____
3	1-1/4	QuikStart TPR	200	4-7/32" (107)	3-3/4" (95)	Plain	NG-03QDO-125-TL-____
3	1-1/4	Anti-Microbial TPR	200	4-7/32" (107)	3-3/4" (95)	Precision Ball	NG-03AMP-125-TL-____
4	1-1/4	QuikStart TPR	275	5-13/32" (137)	4-7/16" (112)	Precision Ball	NG-04QDP-125-TL-____
4	1-1/4	Anti-Microbial TPR	275	5-13/32" (137)	4-7/16" (112)	Precision Ball	NG-04AMP-125-TL-____
5	1-1/4	Santoprene	260	6-1/2" (165)	4-7/16" (112)	Precision Ball	NG-05RPP-125-TL-____
5	1-1/4	QuikStart TPR	325	6-1/2" (165)	4-7/16" (112)	Precision Ball	NG-05QDP-125-TL-____
5	1-1/4	Anti-Microbial TPR	325	6-1/2" (165)	4-7/16" (112)	Precision Ball	NG-05AMP-125-TL-____
6	1-1/4	QuikStart TPR	325	7-1/2" (191)	4-9/16" (116)	Precision Ball	NG-06QDP-125-TL-____
6	1-1/4	QuikStart TPR	325	7-1/2" (191)	4-9/16" (116)	Plain	NG-06QDO-125-TL-____
6	1-1/4	Anti-Microbial TPR	325	7-1/2" (191)	4-9/16" (116)	Precision Ball	NG-06AMP-125-TL-____



GRIP RING STEM DIRECTION LOCK MODELS

(LOCKS SWIVEL ONLY)

Precision sealed ball bearing raceway design for smooth, quiet maintenance free ride.

Wheel Diameter (Inches)	Tread Width (Inches)	Wheel Description	Capacity (lbs)	Load Height Inches (mm)	Swivel Radius Inches (mm)	Wheel Bearing	Model Number
3	1-1/4	QuikStart TPR	200	4-7/32" (107)	3-3/4" (95)	Precision Ball	NG-03QDP-125-DL-____
3	1-1/4	QuikStart TPR	200	4-7/32" (107)	3-3/4" (95)	Plain	NG-03QDO-125-DL-____
3	1-1/4	Anti-Microbial TPR	200	4-7/32" (107)	3-3/4" (95)	Precision Ball	NG-03AMP-125-DL-____
4	1-1/4	QuikStart TPR	275	5-13/32" (137)	4-7/16" (112)	Precision Ball	NG-04QDP-125-DL-____
4	1-1/4	Anti-Microbial TPR	275	5-13/32" (137)	4-7/16" (112)	Precision Ball	NG-04AMP-125-DL-____
5	1-1/4	Santoprene	260	6-1/2" (165)	4-7/16" (112)	Precision Ball	NG-05RPP-125-DL-____
5	1-1/4	QuikStart TPR	325	6-1/2" (165)	4-7/16" (112)	Precision Ball	NG-05QDP-125-DL-____
5	1-1/4	Anti-Microbial TPR	325	6-1/2" (165)	4-7/16" (112)	Precision Ball	NG-05AMP-125-DL-____
6	1-1/4	QuikStart TPR	325	7-1/2" (191)	4-9/16" (116)	Precision Ball	NG-06QDP-125-DL-____
6	1-1/4	QuikStart TPR	325	7-1/2" (191)	4-9/16" (116)	Plain	NG-06QDO-125-DL-____
6	1-1/4	Anti-Microbial TPR	325	7-1/2" (191)	4-9/16" (116)	Precision Ball	NG-06AMP-125-DL-____



Our Directional Lock casters are designed to lock the swivel but not the wheel allowing you to steer your equipment. The directional lock feature is designed to break free under heavier load when the unit is traversing a corner only to lock back into position when the unit resumes a straight course.

Specify Grip Ring Stem (GR) code, see fittings below for dimensions.

GRIP RING STEM FITTINGS

See fittings page for more options.

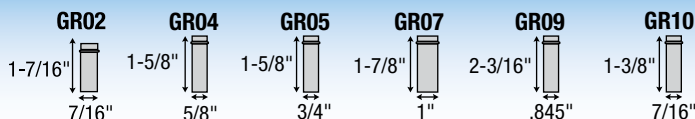

NEXT GENERATION NYLON (NG)

EXPANDING ADAPTER STEM MODELS
FREE SWIVEL • TOTAL LOCK • DIRECTION LOCK



- APPLICATIONS**
- Food Service Equipment
 - Case Carts
 - Utility Carts
 - Medical Equipment
 - Institutional Equipment
 - Hospital Carts
 - Animal Cage Carts

- FEATURES**
- Maintenance free
 - Sealed precision bearing raceway, smooth and quiet
 - **Total Lock Brake** models lock both swivel and wheel
 - Directional lock models lock swivel only (helps with steering)
 - Wheels feature sealed precision ball bearings and full thread guards
 - Resistance to most chemicals
 - Zinc plated top plate
 - Recessed axle with plastic cap covers



Custom Colors Available



Precision sealed ball bearing raceway design for smooth, quiet maintenance free ride.

Our NG series is made of glass filled nylon for added strength and durability. Precision ball bearings are insert molded into the swivel raceway.

EXPANDING ADAPTER STEM MODELS

Precision sealed ball bearing raceway design for smooth, quiet maintenance free ride.

Wheel Diameter (Inches)	Tread Width (Inches)	Wheel Description	Capacity (Lbs)	Load Height Inches (mm)	Swivel Radius Inches (mm)	Wheel Bearing	Model Number
3	1-1/4	QuikStart TPR	200	4-7/32" (107)	2-13/16" (72)	Precision Ball	NG-03QDP-125-SW-_____
3	1-1/4	QuikStart TPR	200	4-7/32" (107)	2-13/16" (72)	Plain	NG-03QDO-125-SW-_____
3	1-1/4	Anti-Microbial TPR	200	4-7/32" (107)	2-13/16" (72)	Precision Ball	NG-03AMP-125-SW-_____
4	1-1/4	QuikStart TPR	275	5-13/32" (137)	3-7/16" (87)	Precision Ball	NG-04QDP-125-SW-_____
4	1-1/4	Anti-Microbial TPR	275	5-13/32" (137)	3-7/16" (87)	Precision Ball	NG-04AMP-125-SW-_____
5	1-1/4	Santoprene	260	6-1/2" (165)	4" (102)	Precision Ball	NG-05RPP-125-SW-_____
5	1-1/4	QuikStart TPR	325	6-1/2" (165)	4" (102)	Precision Ball	NG-05QDP-125-SW-_____
5	1-1/4	Anti-Microbial TPR	325	6-1/2" (165)	4" (102)	Precision Ball	NG-05AMP-125-SW-_____
6	1-1/4	QuikStart TPR	325	7-1/2" (191)	4-9/16" (116)	Precision Ball	NG-06QDP-125-SW-_____
6	1-1/4	QuikStart TPR	325	7-1/2" (191)	4-9/16" (116)	Plain	NG-06QDO-125-SW-_____
6	1-1/4	Anti-Microbial TPR	325	7-1/2" (191)	4-9/16" (116)	Precision Ball	NG-06AMP-125-SW-_____



Note: Antimicrobial casters (AMP) wheels have the darker grey fork and brighter wheel.



NEW New 5" diameter crowned tread Santoprene models now available.

Specify Expanding Adapter Stem (XR) code, see fittings below for dimensions:

EXPANDING ADAPTER STEM FITTINGS

See fittings page for more options.

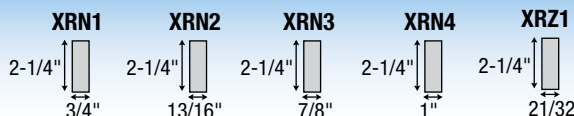

Consult factory for 3" diameter model expanding adapter stems.

NEXT GENERATION NYLON (NG)

EXPANDING ADAPTER STEM MODELS
FREE SWIVEL • TOTAL LOCK • DIRECTION LOCK

EXPANDING ADAPTER STEM TOTAL LOCK MODELS (LOCKS WHEEL AND SWIVEL)

Precision sealed ball bearing raceway design for smooth, quiet maintenance free ride.

Wheel Diameter (Inches)	Tread Width (Inches)	Wheel Description	Capacity (Lbs)	Load Height Inches (mm)	Swivel Radius Inches (mm)	Wheel Bearing	Model Number
3	1-1/4	QuikStart TPR	200	4-7/32" (107)	3-3/4" (95)	Precision Ball	NG-03QDP-125-TL-____
3	1-1/4	QuikStart TPR	200	4-7/32" (107)	3-3/4" (95)	Plain	NG-03QDO-125-TL-____
3	1-1/4	Anti-Microbial TPR	200	4-7/32" (107)	3-3/4" (95)	Precision Ball	NG-03AMP-125-TL-____
4	1-1/4	QuikStart TPR	275	5-13/32" (137)	4-7/16" (112)	Precision Ball	NG-04QDP-125-TL-____
4	1-1/4	Anti-Microbial TPR	275	5-13/32" (137)	4-7/16" (112)	Precision Ball	NG-04AMP-125-TL-____
5	1-1/4	Santoprene	260	6-1/2" (165)	4-7/16" (112)	Precision Ball	NG-05RPP-125-TL-____
5	1-1/4	QuikStart TPR	325	6-1/2" (165)	4-7/16" (112)	Precision Ball	NG-05QDP-125-TL-____
5	1-1/4	Anti-Microbial TPR	325	6-1/2" (165)	4-7/16" (112)	Precision Ball	NG-05AMP-125-TL-____
6	1-1/4	QuikStart TPR	325	7-1/2" (191)	4-9/16" (116)	Precision Ball	NG-06QDP-125-TL-____
6	1-1/4	QuikStart TPR	325	7-1/2" (191)	4-9/16" (116)	Plain	NG-06QDO-125-TL-____
6	1-1/4	Anti-Microbial TPR	325	7-1/2" (191)	4-9/16" (116)	Precision Ball	NG-06AMP-125-TL-____



EXPANDING ADAPTER STEM DIRECTION LOCK MODELS (LOCKS SWIVEL ONLY)

Precision sealed ball bearing raceway design for smooth, quiet maintenance free ride.

Wheel Diameter (Inches)	Tread Width (Inches)	Wheel Description	Capacity (Lbs)	Load Height Inches (mm)	Swivel Radius Inches (mm)	Wheel Bearing	Model Number
3	1-1/4	QuikStart TPR	200	4-7/32" (107)	3-3/4" (95)	Precision Ball	NG-03QDP-125-DL-____
3	1-1/4	QuikStart TPR	200	4-7/32" (107)	3-3/4" (95)	Plain	NG-03QDO-125-DL-____
3	1-1/4	Anti-Microbial TPR	200	4-7/32" (107)	3-3/4" (95)	Precision Ball	NG-03AMP-125-DL-____
4	1-1/4	QuikStart TPR	275	5-13/32" (137)	4-7/16" (112)	Precision Ball	NG-04QDP-125-DL-____
4	1-1/4	Anti-Microbial TPR	275	5-13/32" (137)	4-7/16" (112)	Precision Ball	NG-04AMP-125-DL-____
5	1-1/4	Santoprene	260	6-1/2" (165)	4-7/16" (112)	Precision Ball	NG-05RPP-125-DL-____
5	1-1/4	QuikStart TPR	325	6-1/2" (165)	4-7/16" (112)	Precision Ball	NG-05QDP-125-DL-____
5	1-1/4	Anti-Microbial TPR	325	6-1/2" (165)	4-7/16" (112)	Precision Ball	NG-05AMP-125-DL-____
6	1-1/4	QuikStart TPR	325	7-1/2" (191)	4-9/16" (116)	Precision Ball	NG-06QDP-125-DL-____
6	1-1/4	QuikStart TPR	325	7-1/2" (191)	4-9/16" (116)	Plain	NG-06QDO-125-DL-____
6	1-1/4	Anti-Microbial TPR	325	7-1/2" (191)	4-9/16" (116)	Precision Ball	NG-06AMP-125-DL-____



Our Directional Lock casters are designed to lock the swivel but not the wheel allowing you to steer your equipment. The directional lock feature is designed to break free under heavier load when the unit is traversing a corner only to lock back into position when the unit resumes a straight course.

Consult factory for 3" diameter model expanding adapter stems.

Specify Expanding Adapter Stem (XR) code, see fittings below for dimensions:

EXPANDING ADAPTER STEM FITTINGS

See fittings page for more options.

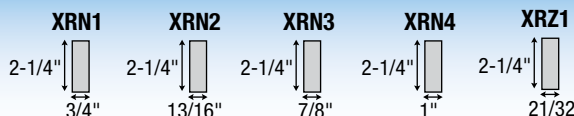

NEXT GENERATION NYLON (NG)

THREADED STEM MODELS
FREE SWIVEL • TOTAL LOCK • DIRECTION LOCK



- APPLICATIONS**
- Food Service Equipment
 - Case Carts
 - Utility Carts
 - Medical Equipment
 - Institutional Equipment
 - Hospital Carts
 - Animal Cage Carts

- FEATURES**
- Maintenance free
 - Sealed precision bearing raceway, smooth and quiet
 - **Total Lock Brake** models lock both swivel and wheel
 - Directional lock models lock swivel only (helps with steering)
 - Wheels feature sealed precision ball bearings and full thread guards
 - Resistance to most chemicals
 - Zinc plated top plate
 - Recessed axle with plastic cap covers



Custom Colors Available



Precision sealed ball bearing raceway design for smooth, quiet maintenance free ride.

Our NG series is made of glass filled nylon for added strength and durability. Precision ball bearings are insert molded into the swivel raceway.

THREADED STEM MODELS

Precision sealed ball bearing raceway design for smooth, quiet maintenance free ride.

Wheel Diameter (Inches)	Tread Width (Inches)	Wheel Description	Capacity (Lbs)	Load Height Inches (mm)	Swivel Radius Inches (mm)	Wheel Bearing	Model Number
3	1-1/4	QuikStart TPR	200	4-7/32" (107)	2-13/16" (72)	Precision Ball	NG-03QDP-125-SW-_____
3	1-1/4	QuikStart TPR	200	4-7/32" (107)	2-13/16" (72)	Plain	NG-03QDO-125-SW-_____
3	1-1/4	Anti-Microbial TPR	200	4-7/32" (107)	2-13/16" (72)	Precision Ball	NG-03AMP-125-SW-_____
4	1-1/4	QuikStart TPR	275	5-13/32" (137)	3-7/16" (87)	Precision Ball	NG-04QDP-125-SW-_____
4	1-1/4	Anti-Microbial TPR	275	5-13/32" (137)	3-7/16" (87)	Precision Ball	NG-04AMP-125-SW-_____
5	1-1/4	Santoprene	260	6-1/2" (165)	4" (102)	Precision Ball	NG-05RPP-125-SW-_____
5	1-1/4	QuikStart TPR	325	6-1/2" (165)	4" (102)	Precision Ball	NG-05QDP-125-SW-_____
5	1-1/4	Anti-Microbial TPR	325	6-1/2" (165)	4" (102)	Precision Ball	NG-05AMP-125-SW-_____
6	1-1/4	QuikStart TPR	325	7-1/2" (191)	4-9/16" (116)	Precision Ball	NG-06QDP-125-SW-_____
6	1-1/4	QuikStart TPR	325	7-1/2" (191)	4-9/16" (116)	Plain	NG-06QDO-125-SW-_____
6	1-1/4	Anti-Microbial TPR	325	7-1/2" (191)	4-9/16" (116)	Precision Ball	NG-06AMP-125-SW-_____



Note: Antimicrobial casters (AMP) wheels have the darker grey fork and brighter wheel.

NEW



New 5" diameter crowned tread Santoprene models now available.

Specify Threaded Stem (TS) code, see fittings below for dimensions:

THREADED STEM FITTINGS

See fittings page for more options.

TS02

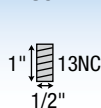

TS03

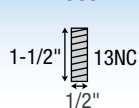

TS05

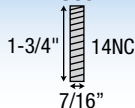

TS21



TS22

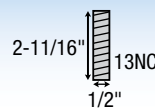

NEXT GENERATION NYLON (NG)

THREADED STEM MODELS

FREE SWIVEL • TOTAL LOCK • DIRECTION LOCK

THREADED STEM TOTAL LOCK MODELS (LOCKS WHEEL AND SWIVEL)

Precision sealed ball bearing raceway design for smooth, quiet maintenance free ride.

Wheel Diameter (Inches)	Tread Width (Inches)	Wheel Description	Capacity (lbs)	Load Height Inches (mm)	Swivel Radius Inches (mm)	Wheel Bearing	Model Number
3	1-1/4	QuikStart TPR	200	4-7/32" (107)	3-3/4" (95)	Precision Ball	NG-03QDP-125-TL-____
3	1-1/4	QuikStart TPR	200	4-7/32" (107)	3-3/4" (95)	Plain	NG-03QDO-125-TL-____
3	1-1/4	Anti-Microbial TPR	200	4-7/32" (107)	3-3/4" (95)	Precision Ball	NG-03AMP-125-TL-____
4	1-1/4	QuikStart TPR	275	5-13/32" (137)	4-7/16" (112)	Precision Ball	NG-04QDP-125-TL-____
4	1-1/4	Anti-Microbial TPR	275	5-13/32" (137)	4-7/16" (112)	Precision Ball	NG-04AMP-125-TL-____
5	1-1/4	Santoprene	260	6-1/2" (165)	4-7/16" (112)	Precision Ball	NG-05RPP-125-TL-____
5	1-1/4	QuikStart TPR	325	6-1/2" (165)	4-7/16" (112)	Precision Ball	NG-05QDP-125-TL-____
5	1-1/4	Anti-Microbial TPR	325	6-1/2" (165)	4-7/16" (112)	Precision Ball	NG-05AMP-125-TL-____
6	1-1/4	QuikStart TPR	325	7-1/2" (191)	4-9/16" (116)	Precision Ball	NG-06QDP-125-TL-____
6	1-1/4	QuikStart TPR	325	7-1/2" (191)	4-9/16" (116)	Plain	NG-06QDO-125-TL-____
6	1-1/4	Anti-Microbial TPR	325	7-1/2" (191)	4-9/16" (116)	Precision Ball	NG-06AMP-125-TL-____



THREADED STEM DIRECTION LOCK MODELS (LOCKS SWIVEL ONLY)

Precision sealed ball bearing raceway design for smooth, quiet maintenance free ride.

Wheel Diameter (Inches)	Tread Width (Inches)	Wheel Description	Capacity (lbs)	Load Height Inches (mm)	Swivel Radius Inches (mm)	Wheel Bearing	Model Number
3	1-1/4	QuikStart TPR	200	4-7/32" (107)	3-3/4" (95)	Precision Ball	NG-03QDP-125-DL-____
3	1-1/4	QuikStart TPR	200	4-7/32" (107)	3-3/4" (95)	Plain	NG-03QDO-125-DL-____
3	1-1/4	Anti-Microbial TPR	200	4-7/32" (107)	3-3/4" (95)	Precision Ball	NG-03AMP-125-DL-____
4	1-1/4	QuikStart TPR	275	5-13/32" (137)	4-7/16" (112)	Precision Ball	NG-04QDP-125-DL-____
4	1-1/4	Anti-Microbial TPR	275	5-13/32" (137)	4-7/16" (112)	Precision Ball	NG-04AMP-125-DL-____
5	1-1/4	Santoprene	260	6-1/2" (165)	4-7/16" (112)	Precision Ball	NG-05RPP-125-DL-____
5	1-1/4	QuikStart TPR	325	6-1/2" (165)	4-7/16" (112)	Precision Ball	NG-05QDP-125-DL-____
5	1-1/4	Anti-Microbial TPR	325	6-1/2" (165)	4-7/16" (112)	Precision Ball	NG-05AMP-125-DL-____
6	1-1/4	QuikStart TPR	325	7-1/2" (191)	4-9/16" (116)	Precision Ball	NG-06QDP-125-DL-____
6	1-1/4	QuikStart TPR	325	7-1/2" (191)	4-9/16" (116)	Plain	NG-06QDO-125-DL-____
6	1-1/4	Anti-Microbial TPR	325	7-1/2" (191)	4-9/16" (116)	Precision Ball	NG-06AMP-125-DL-____



Our Directional Lock casters are designed to lock the swivel but not the wheel allowing you to steer your equipment. The directional lock feature is designed to break free under heavier load when the unit is traversing a corner only to lock back into position when the unit resumes a straight course.

Specify Threaded Stem (TS) code, see fittings below for dimensions:

THREADED STEM FITTINGS

See fittings page for more options.

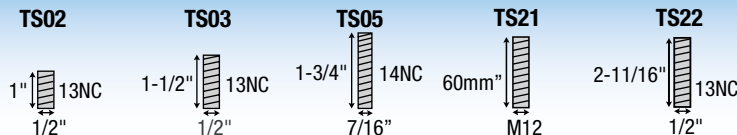

NEXT GENERATION NYLON (NG)

ROUND/SQUARE STEM MODELS
FREE SWIVEL • TOTAL LOCK • DIRECTION LOCK



- APPLICATIONS**
- Food Service Equipment
 - Case Carts
 - Utility Carts
 - Medical Equipment
 - Institutional Equipment
 - Hospital Carts
 - Animal Cage Carts

- FEATURES**
- Maintenance free
 - Sealed precision bearing raceway, smooth and quiet
 - **Total Lock Brake** models lock both swivel and wheel
 - Directional lock models lock swivel only (helps with steering)
 - Wheels feature sealed precision ball bearings and full thread guards
 - Resistance to most chemicals
 - Zinc plated top plate
 - Recessed axle with plastic cap covers



Custom Colors Available



Precision sealed ball bearing raceway design for smooth, quiet maintenance free ride.

Our NG series is made of glass filled nylon for added strength and durability. Precision ball bearings are insert molded into the swivel raceway.

ROUND OR SQUARE STEM MODELS

Precision sealed ball bearing raceway design for smooth, quiet maintenance free ride.

Wheel Diameter (Inches)	Tread Width (Inches)	Wheel Description	Capacity (Lbs)	Load Height Inches (mm)	Swivel Radius Inches (mm)	Wheel Bearing	Model Number
3	1-1/4	QuikStart TPR	200	4-7/32" (107)	2-13/16" (72)	Precision Ball	NG-03QDP-125-SW-_____
3	1-1/4	QuikStart TPR	200	4-7/32" (107)	2-13/16" (72)	Plain	NG-03QDO-125-SW-_____
3	1-1/4	Anti-Microbial TPR	200	4-7/32" (107)	2-13/16" (72)	Precision Ball	NG-03AMP-125-SW-_____
4	1-1/4	QuikStart TPR	275	5-13/32" (137)	3-7/16" (87)	Precision Ball	NG-04QDP-125-SW-_____
4	1-1/4	Anti-Microbial TPR	275	5-13/32" (137)	3-7/16" (87)	Precision Ball	NG-04AMP-125-SW-_____
5	1-1/4	Santoprene	260	6-1/2" (165)	4" (102)	Precision Ball	NG-05RPP-125-SW-_____
5	1-1/4	QuikStart TPR	325	6-1/2" (165)	4" (102)	Precision Ball	NG-05QDP-125-SW-_____
5	1-1/4	Anti-Microbial TPR	325	6-1/2" (165)	4" (102)	Precision Ball	NG-05AMP-125-SW-_____
6	1-1/4	QuikStart TPR	325	7-1/2" (191)	4-9/16" (116)	Precision Ball	NG-06QDP-125-SW-_____
6	1-1/4	QuikStart TPR	325	7-1/2" (191)	4-9/16" (116)	Plain	NG-06QDO-125-SW-_____
6	1-1/4	Anti-Microbial TPR	325	7-1/2" (191)	4-9/16" (116)	Precision Ball	NG-06AMP-125-SW-_____



Note: Antimicrobial casters (AMP) wheels have the darker grey fork and brighter wheel.

NEW



New 5" diameter crowned tread Santoprene models now available.

NEW



Rigid model available for 5" and 6" diameter wheels. Change SW to RG.

ROUND STEM FITTINGS

RS01	RS02	RS03	RS04	RS05
45mm 22mm	45mm 25.4mm	45mm 27.8mm	45mm 20.5mm	45mm 32mm

SQUARE STEM FITTINGS

SQ01	SQ02	SQ03
2" No Holes 3/4"	1.75" 3 Holes 1"	2.2" Square Grip Ring .850"

Specify Round Stem (RS) code, or Square Stem code (SQ) see fittings at left for dimensions.

See fittings page for more options.

NEXT GENERATION NYLON (NG)

ROUND/SQUARE STEM MODELS
FREE SWIVEL • TOTAL LOCK • DIRECTION LOCK

ROUND OR SQUARE STEM TOTAL LOCK MODELS

(LOCKS WHEEL AND SWIVEL)

Precision sealed ball bearing raceway design for smooth, quiet maintenance free ride.

Wheel Diameter (Inches)	Tread Width (Inches)	Wheel Description	Capacity (lbs)	Load Height Inches (mm)	Swivel Radius Inches (mm)	Wheel Bearing	Model Number
3	1-1/4	QuikStart TPR	200	4-7/32" (107)	3-3/4" (95)	Precision Ball	NG-03QDP-125-TL-____
3	1-1/4	QuikStart TPR	200	4-7/32" (107)	3-3/4" (95)	Plain	NG-03QDO-125-TL-____
3	1-1/4	Anti-Microbial TPR	200	4-7/32" (107)	3-3/4" (95)	Precision Ball	NG-03AMP-125-TL-____
4	1-1/4	QuikStart TPR	275	5-13/32" (137)	4-7/16" (112)	Precision Ball	NG-04QDP-125-TL-____
4	1-1/4	Anti-Microbial TPR	275	5-13/32" (137)	4-7/16" (112)	Precision Ball	NG-04AMP-125-TL-____
5	1-1/4	Santoprene	260	6-1/2" (165)	4-7/16" (112)	Precision Ball	NG-05RPP-125-TL-____
5	1-1/4	QuikStart TPR	325	6-1/2" (165)	4-7/16" (112)	Precision Ball	NG-05QDP-125-TL-____
5	1-1/4	Anti-Microbial TPR	325	6-1/2" (165)	4-7/16" (112)	Precision Ball	NG-05AMP-125-TL-____
6	1-1/4	QuikStart TPR	325	7-1/2" (191)	4-9/16" (116)	Precision Ball	NG-06QDP-125-TL-____
6	1-1/4	QuikStart TPR	325	7-1/2" (191)	4-9/16" (116)	Plain	NG-06QDO-125-TL-____
6	1-1/4	Anti-Microbial TPR	325	7-1/2" (191)	4-9/16" (116)	Precision Ball	NG-06AMP-125-TL-____



ROUND OR SQUARE STEM DIRECTION LOCK MODELS

(LOCKS SWIVEL ONLY)

Precision sealed ball bearing raceway design for smooth, quiet maintenance free ride.

Wheel Diameter (Inches)	Tread Width (Inches)	Wheel Description	Capacity (lbs)	Load Height Inches (mm)	Swivel Radius Inches (mm)	Wheel Bearing	Model Number
3	1-1/4	QuikStart TPR	200	4-7/32" (107)	3-3/4" (95)	Precision Ball	NG-03QDP-125-DL-____
3	1-1/4	QuikStart TPR	200	4-7/32" (107)	3-3/4" (95)	Plain	NG-03QDO-125-DL-____
3	1-1/4	Anti-Microbial TPR	200	4-7/32" (107)	3-3/4" (95)	Precision Ball	NG-03AMP-125-DL-____
4	1-1/4	QuikStart TPR	275	5-13/32" (137)	4-7/16" (112)	Precision Ball	NG-04QDP-125-DL-____
4	1-1/4	Anti-Microbial TPR	275	5-13/32" (137)	4-7/16" (112)	Precision Ball	NG-04AMP-125-DL-____
5	1-1/4	Santoprene	260	6-1/2" (165)	4-7/16" (112)	Precision Ball	NG-05RPP-125-DL-____
5	1-1/4	QuikStart TPR	325	6-1/2" (165)	4-7/16" (112)	Precision Ball	NG-05QDP-125-DL-____
5	1-1/4	Anti-Microbial TPR	325	6-1/2" (165)	4-7/16" (112)	Precision Ball	NG-05AMP-125-DL-____
6	1-1/4	QuikStart TPR	325	7-1/2" (191)	4-9/16" (116)	Precision Ball	NG-06QDP-125-DL-____
6	1-1/4	QuikStart TPR	325	7-1/2" (191)	4-9/16" (116)	Plain	NG-06QDO-125-DL-____
6	1-1/4	Anti-Microbial TPR	325	7-1/2" (191)	4-9/16" (116)	Precision Ball	NG-06AMP-125-DL-____



Our Directional Lock casters are designed to lock the swivel but not the wheel allowing you to steer your equipment. The directional lock feature is designed to break free under heavier load when the unit is traversing a corner only to lock back into position when the unit resumes a straight course.



New rigid brake models now available on 5" models. Change TL to RB

ROUND STEM FITTINGS

RS01	RS02	RS03	RS04	RS05
45mm 22mm	45mm 25.4mm	45mm 27.8mm	45mm 20.5mm	45mm 32mm

SQUARE STEM FITTINGS

SQ01	SQ02	SQ03
2" No Holes 3/4"	1.75" 3 Holes 1"	2.2" Square Grip Ring .850"

Specify Round Stem (RS) code, or Square Stem code (SQ) see fittings at left for dimensions.

NYLON PLUS STAINLESS (NS)

TOP PLATE MODELS

FREE SWIVEL • TOTAL LOCK • DIRECTION LOCK



- APPLICATIONS**
- Food Service Equipment
 - Case Carts
 - Utility Carts
 - Medical Equipment
 - Institutional Equipment
 - Hospital Carts
 - Animal Cage Carts
 - Pharmaceutical Equipment

304 Stainless steel top plate and components!



Precision sealed ball bearing raceway design for smooth, quiet maintenance free ride.

- FEATURES**
- Sealed stainless steel precision bearing raceway, smooth and quite
 - **Total lock and direction lock** brake models available
 - Wheels feature sealed stainless precision ball bearings and full thread guards
 - Resistant to most chemicals
 - Recessed Stainless axle with plastic cap covers
 - Maintenance free, requires no lubrication for rig or wheel

Our NS Series is similar to NG Series but with the added benefit of 304 stainless components making it excellent for wet environments.

SWIVEL TOP PLATE MODELS

Precision sealed ball bearing raceway design for smooth, quiet maintenance free ride.

Wheel Diameter (Inches)	Tread Width (Inches)	Wheel Description	Capacity (Lbs)	Load Height Inches (mm)	Swivel Radius Inches (mm)	Wheel Bearing	Model Number
3	1-1/4	QuikStart TPR	200	4-1/4" (108)	2-13/16" (72)	Precision Ball	NS-03QDP-125-SW-TP01
3	1-1/4	QuikStart TPR	200	4-1/4" (108)	2-13/16" (72)	Plain	NS-03QDO-125-SW-TP01
3	1-1/4	Anti-Microbial TPR	200	4-1/4" (108)	2-13/16" (72)	Precision Ball	NS-03AMP-125-SW-TP01
4	1-1/4	QuikStart TPR	275	5-3/4" (146)	3-7/16" (87)	Precision Ball	NS-04QDP-125-SW-TP01
4	1-1/4	Anti-Microbial TPR	275	5-3/4" (146)	3-7/16" (87)	Precision Ball	NS-04AMP-125-SW-TP01
5	1-1/4	QuikStart TPR	325	6-7/8" (174)	4" (102)	Precision Ball	NS-05QDP-125-SW-TP01
5	1-1/4	Anti-Microbial TPR	325	6-7/8" (174)	4" (102)	Precision Ball	NS-05AMP-125-SW-TP01
6	1-1/4	QuikStart TPR	325	7-11/16" (195)	4-9/16" (116)	Precision Ball	NS-06QDP-125-SW-TP01
6	1-1/4	QuikStart TPR	325	7-11/16" (195)	4-9/16" (116)	Plain	NS-06QDO-125-SW-TP01
6	1-1/4	Anti-Microbial TPR	325	7-11/16" (195)	4-9/16" (116)	Precision Ball	NS-06AMP-125-SW-TP01



316SS fittings available for non-magnetic applications. Consult factory.



NEW Rigid model available for 5" and 6" diameter wheels. 3" model coming soon. Change SW to RG.

TOP PLATE FITTING

Swivel Top Plate Pattern

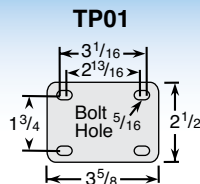

Custom Colors Available

NYLON PLUS STAINLESS (NS)

TOP PLATE MODELS

FREE SWIVEL • TOTAL LOCK • DIRECTION LOCK

SWIVEL TOP PLATE TOTAL LOCK MODELS

(LOCKS WHEEL AND SWIVEL)

Precision sealed ball bearing raceway design for smooth, quiet maintenance free ride.

Wheel Diameter (Inches)	Tread Width (Inches)	Wheel Description	Capacity (Lbs)	Load Height Inches (mm)	Swivel Radius Inches (mm)	Wheel Bearing	Model Number
3	1-1/4	QuikStart TPR	200	4-1/4" (108)	3-3/4" (95)	Precision Ball	NS-03QDP-125-TL-TP01
3	1-1/4	QuikStart TPR	200	4-1/4" (108)	3-3/4" (95)	Plain	NS-03QDO-125-TL-TP01
3	1-1/4	Anti-Microbial TPR	200	4-1/4" (108)	3-3/4" (95)	Precision Ball	NS-03AMP-125-TL-TP01
4	1-1/4	QuikStart TPR	275	5-3/4" (146)	4-7/16" (112)	Precision Ball	NS-04QDP-125-TL-TP01
4	1-1/4	Anti-Microbial TPR	275	5-3/4" (146)	4-7/16" (112)	Precision Ball	NS-04AMP-125-TL-TP01
5	1-1/4	QuikStart TPR	325	6-7/8" (174)	4-7/16" (112)	Precision Ball	NS-05QDP-125-TL-TP01
5	1-1/4	Anti-Microbial TPR	325	6-7/8" (174)	4-7/16" (112)	Precision Ball	NS-05AMP-125-TL-TP01
6	1-1/4	QuikStart TPR	325	7-11/16" (195)	4-9/16" (116)	Precision Ball	NS-06QDP-125-TL-TP01
6	1-1/4	QuikStart TPR	325	7-11/16" (195)	4-9/16" (116)	Plain	NS-06QDO-125-TL-TP01
6	1-1/4	Anti-Microbial TPR	325	7-11/16" (195)	4-9/16" (116)	Precision Ball	NS-06AMP-125-TL-TP01



SWIVEL TOP PLATE DIRECTION LOCK MODELS

(LOCKS SWIVEL ONLY)

Precision sealed ball bearing raceway design for smooth, quiet maintenance free ride.

Wheel Diameter (Inches)	Tread Width (Inches)	Wheel Description	Capacity (Lbs)	Load Height Inches (mm)	Swivel Radius Inches (mm)	Wheel Bearing	Model Number
3	1-1/4	QuikStart TPR	200	4-1/4" (108)	3-3/4" (95)	Precision Ball	NS-03QDP-125-DL-TP01
3	1-1/4	QuikStart TPR	200	4-1/4" (108)	3-3/4" (95)	Plain	NS-03QDO-125-DL-TP01
3	1-1/4	Anti-Microbial TPR	200	4-1/4" (108)	3-3/4" (95)	Precision Ball	NS-03AMP-125-DL-TP01
4	1-1/4	QuikStart TPR	275	5-3/4" (146)	4-7/16" (112)	Precision Ball	NS-04QDP-125-DL-TP01
4	1-1/4	Anti-Microbial TPR	275	5-3/4" (146)	4-7/16" (112)	Precision Ball	NS-04AMP-125-DL-TP01
5	1-1/4	QuikStart TPR	325	6-7/8" (174)	4-7/16" (112)	Precision Ball	NS-05QDP-125-DL-TP01
5	1-1/4	Anti-Microbial TPR	325	6-7/8" (174)	4-7/16" (112)	Precision Ball	NS-05AMP-125-DL-TP01
6	1-1/4	QuikStart TPR	325	7-11/16" (195)	4-9/16" (116)	Precision Ball	NS-06QDP-125-DL-TP01
6	1-1/4	QuikStart TPR	325	7-11/16" (195)	4-9/16" (116)	Plain	NS-06QDO-125-DL-TP01
6	1-1/4	Anti-Microbial TPR	325	7-11/16" (195)	4-9/16" (116)	Precision Ball	NS-06AMP-125-DL-TP01



Our Directional Lock casters are designed to lock the swivel but not the wheel allowing you to steer your equipment. The directional lock feature is designed to break free under heavier load when the unit is traversing a corner only to lock back into position when the unit resumes a straight course.



New rigid brake models now available on 5" models. Change TL to RB

TOP PLATE FITTING

Swivel Top Plate Pattern

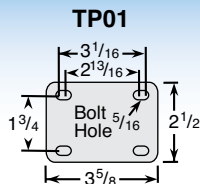

NYLON PLUS STAINLESS (NS)

HOLLOW KINGPIN MODELS
FREE SWIVEL • TOTAL LOCK • DIRECTION LOCK



- APPLICATIONS**
- Food Service Equipment
 - Case Carts
 - Utility Carts
 - Medical Equipment
 - Institutional Equipment
 - Hospital Carts
 - Animal Cage Carts
 - Pharmaceutical Equipment

304 Stainless steel components!



Precision sealed ball bearing raceway design for smooth, quiet maintenance free ride.

- FEATURES**
- Sealed stainless steel precision bearing raceway, smooth and quite
 - **Total lock and direction lock** brake models available
 - Wheels feature sealed stainless precision ball bearings and full thread guards
 - Resistant to most chemicals
 - Recessed Stainless axle with plastic cap covers
 - Maintenance free, requires no lubrication for rig or wheel

Our NS Series is similar to NG Series but with the added benefit of 304 stainless components making it excellent for wet environments.

HOLLOW KINGPIN MODELS

Precision sealed ball bearing raceway design for smooth, quiet maintenance free ride.

Wheel Diameter (Inches)	Tread Width (Inches)	Wheel Description	Capacity (Lbs)	Load Height Inches (mm)	Swivel Radius Inches (mm)	Wheel Bearing	Model Number
3	1-1/4	QuikStart TPR	200	4-7/32" (107)	2-13/16" (72)	Precision Ball	NS-03QDP-125-SW-HKU4
3	1-1/4	QuikStart TPR	200	4-7/32" (107)	2-13/16" (72)	Plain	NS-03QDO-125-SW-HKU4
3	1-1/4	Anti-Microbial TPR	200	4-7/32" (107)	2-13/16" (72)	Precision Ball	NS-03AMP-125-SW-HKU4
4	1-1/4	QuikStart TPR	275	5-13/32" (137)	3-7/16" (87)	Precision Ball	NS-04QDP-125-SW-HKU1
4	1-1/4	Anti-Microbial TPR	275	5-13/32" (137)	3-7/16" (87)	Precision Ball	NS-04AMP-125-SW-HKU1
5	1-1/4	QuikStart TPR	325	6-1/2" (165)	4" (102)	Precision Ball	NS-05QDP-125-SW-HKU1
5	1-1/4	Anti-Microbial TPR	325	6-1/2" (165)	4" (102)	Precision Ball	NS-05AMP-125-SW-HKU1
6	1-1/4	QuikStart TPR	325	7-1/2" (191)	4-9/16" (116)	Precision Ball	NS-06QDP-125-SW-HKU1
6	1-1/4	QuikStart TPR	325	7-1/2" (191)	4-9/16" (116)	Plain	NS-06QDO-125-SW-HKU1
6	1-1/4	Anti-Microbial TPR	325	7-1/2" (191)	4-9/16" (116)	Precision Ball	NS-06AMP-125-SW-HKU1



316SS fittings available for non-magnetic applications. Consult factory.

NEW



Rigid model available for 5" and 6" diameter wheels. 3" model coming soon. Change SW to RG.

HOLLOW KINGPIN

Caster is **provided unassembled** to make it easy to add your choice of fitting. If you would like these assembled change **HKU4** to **HKO4** on 3" diameter models. Change **HKU1** to **HKO1** on 4" to 6" diameter models. 3/8" I.D. on 3" diam. models; 1/2" I.D. on 4", 5", & 6" diam. models.



Custom Colors Available

NYLON PLUS STAINLESS (NS)

HOLLOW KINGPIN MODELS
FREE SWIVEL • TOTAL LOCK • DIRECTION LOCK

HOLLOW KINGPIN TOTAL LOCK MODELS

(LOCKS WHEEL AND SWIVEL)

Precision sealed ball bearing raceway design for smooth, quiet maintenance free ride.

Wheel Diameter (Inches)	Tread Width (Inches)	Wheel Description	Capacity (lbs)	Load Height Inches (mm)	Swivel Radius Inches (mm)	Wheel Bearing	Model Number
3	1-1/4	QuikStart TPR	200	4-7/32" (107)	3-3/4" (95)	Precision Ball	NS-03QDP-125-TL-HKU4
3	1-1/4	QuikStart TPR	200	4-7/32" (107)	3-3/4" (95)	Plain	NS-03QDO-125-TL-HKU4
3	1-1/4	Anti-Microbial TPR	200	4-7/32" (107)	3-3/4" (95)	Precision Ball	NS-03AMP-125-TL-HKU4
4	1-1/4	QuikStart TPR	275	5-13/32" (137)	4-7/16" (112)	Precision Ball	NS-04QDP-125-TL-HKU1
4	1-1/4	Anti-Microbial TPR	275	5-13/32" (137)	4-7/16" (112)	Precision Ball	NS-04AMP-125-TL-HKU1
5	1-1/4	QuikStart TPR	325	6-1/2" (165)	4-7/16" (112)	Precision Ball	NS-05QDP-125-TL-HKU1
5	1-1/4	Anti-Microbial TPR	325	6-1/2" (165)	4-7/16" (112)	Precision Ball	NS-05AMP-125-TL-HKU1
6	1-1/4	QuikStart TPR	325	7-1/2" (191)	4-9/16" (116)	Precision Ball	NS-06QDP-125-TL-HKU1
6	1-1/4	QuikStart TPR	325	7-1/2" (191)	4-9/16" (116)	Plain	NS-06QDO-125-TL-HKU1
6	1-1/4	Anti-Microbial TPR	325	7-1/2" (191)	4-9/16" (116)	Precision Ball	NS-06AMP-125-TL-HKU1



HOLLOW KINGPIN DIRECTION LOCK MODELS

(LOCKS SWIVEL ONLY)

Precision sealed ball bearing raceway design for smooth, quiet maintenance free ride.

Wheel Diameter (Inches)	Tread Width (Inches)	Wheel Description	Capacity (lbs)	Load Height Inches (mm)	Swivel Radius Inches (mm)	Wheel Bearing	Model Number
3	1-1/4	QuikStart TPR	200	4-7/32" (107)	3-3/4" (95)	Precision Ball	NS-03QDP-125-DL-HKU4
3	1-1/4	QuikStart TPR	200	4-7/32" (107)	3-3/4" (95)	Plain	NS-03QDO-125-DL-HKU4
3	1-1/4	Anti-Microbial TPR	200	4-7/32" (107)	3-3/4" (95)	Precision Ball	NS-03AMP-125-DL-HKU4
4	1-1/4	QuikStart TPR	275	5-13/32" (137)	4-7/16" (112)	Precision Ball	NS-04QDP-125-DL-HKU1
4	1-1/4	Anti-Microbial TPR	275	5-13/32" (137)	4-7/16" (112)	Precision Ball	NS-04AMP-125-DL-HKU1
5	1-1/4	QuikStart TPR	325	6-1/2" (165)	4-7/16" (112)	Precision Ball	NS-05QDP-125-DL-HKU1
5	1-1/4	Anti-Microbial TPR	325	6-1/2" (165)	4-7/16" (112)	Precision Ball	NS-05AMP-125-DL-HKU1
6	1-1/4	QuikStart TPR	325	7-1/2" (191)	4-9/16" (116)	Precision Ball	NS-06QDP-125-DL-HKU1
6	1-1/4	QuikStart TPR	325	7-1/2" (191)	4-9/16" (116)	Plain	NS-06QDO-125-DL-HKU1
6	1-1/4	Anti-Microbial TPR	325	7-1/2" (191)	4-9/16" (116)	Precision Ball	NS-06AMP-125-DL-HKU1



Our Directional Lock casters are designed to lock the swivel but not the wheel allowing you to steer your equipment. The directional lock feature is designed to break free under heavier load when the unit is traversing a corner only to lock back into position when the unit resumes a straight course.



New rigid brake models now available on 5" models. Change TL to RB

HOLLOW KINGPIN

Caster is **provided unassembled** to make it easy to add your choice of fitting. If you would like these assembled change **HKU4** to **HK04** on 3" diameter models. Change **HKU1** to **HK01** on 4" to 6" diameter models. 3/8" I.D. on 3" diam. models; 1/2" I.D. on 4", 5", & 6" diam. models.

NYLON PLUS STAINLESS (NS)

EXPANDING ADAPTER STEM MODELS
 FREE SWIVEL • TOTAL LOCK • DIRECTION LOCK



- APPLIC**
- Food Service Equipment
 - Case Carts
 - Utility Carts
 - Medical Equipment
 - Institutional Equipment
 - Hospital Carts
 - Animal Cage Carts
 - Pharmaceutical Equipment

- FEATURES**
- Sealed stainless steel precision bearing raceway, smooth and quite
 - **Total lock and direction lock** brake models available
 - Wheels feature sealed stainless precision ball bearings and full thread guards
 - Resistant to most chemicals
 - Recessed Stainless axle with plastic cap covers
 - Maintenance free, requires no lubrication for rig or wheel

304 Stainless steel components!

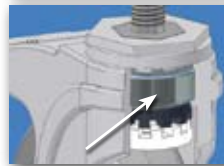

Precision sealed ball bearing raceway design for smooth, quiet maintenance free ride.

Our NS Series is similar to NG Series but with the added benefit of 304 stainless components making it excellent for wet environments.

EXPANDING ADAPTER STEM MODELS

Precision sealed ball bearing raceway design for smooth, quiet maintenance free ride.

Wheel Diameter (Inches)	Tread Width (Inches)	Wheel Description	Capacity (Lbs)	Load Height Inches (mm)	Swivel Radius Inches (mm)	Wheel Bearing	Model Number
3	1-1/4	QuikStart TPR	200	4-7/32" (107)	2-13/16" (72)	Precision Ball	NS-03QDP-125-SW-_____
3	1-1/4	QuikStart TPR	200	4-7/32" (107)	2-13/16" (72)	Plain	NS-03QDO-125-SW-_____
3	1-1/4	Anti-Microbial TPR	200	4-7/32" (107)	2-13/16" (72)	Precision Ball	NS-03AMP-125-SW-_____
4	1-1/4	QuikStart TPR	275	5-13/32" (137)	3-7/16" (87)	Precision Ball	NS-04QDP-125-SW-_____
4	1-1/4	Anti-Microbial TPR	275	5-13/32" (137)	3-7/16" (87)	Precision Ball	NS-04AMP-125-SW-_____
5	1-1/4	QuikStart TPR	325	6-1/2" (165)	4" (102)	Precision Ball	NS-05QDP-125-SW-_____
5	1-1/4	Anti-Microbial TPR	325	6-1/2" (165)	4" (102)	Precision Ball	NS-05AMP-125-SW-_____
6	1-1/4	QuikStart TPR	325	7-1/2" (191)	4-9/16" (116)	Precision Ball	NS-06QDP-125-SW-_____
6	1-1/4	QuikStart TPR	325	7-1/2" (191)	4-9/16" (116)	Plain	NS-06QDO-125-SW-_____
6	1-1/4	Anti-Microbial TPR	325	7-1/2" (191)	4-9/16" (116)	Precision Ball	NS-06AMP-125-SW-_____



316SS fittings available for non-magnetic applications. Consult factory.

Consult factory for 3" diameter model expanding adapter stems.

Specify Expanding Adapter Stem Round Nylon (XRN) code, Round Zamac (XRZ). see fittings at left for dimensions:

EXPANDING ADAPTER STEM FITTINGS

See fittings page for more options.

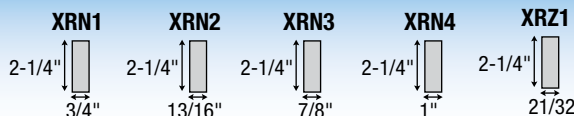

Custom Colors Available

NYLON PLUS STAINLESS (NS)

EXPANDING ADAPTER STEM MODELS
FREE SWIVEL • TOTAL LOCK • DIRECTION LOCK

EXPANDING ADAPTER STEM TOTAL LOCK MODELS (LOCKS WHEEL AND SWIVEL)

Precision sealed ball bearing raceway design for smooth, quiet maintenance free ride.

Wheel Diameter (Inches)	Tread Width (Inches)	Wheel Description	Capacity (Lbs)	Load Height Inches (mm)	Swivel Radius Inches (mm)	Wheel Bearing	Model Number
3	1-1/4	QuikStart TPR	200	4-7/32" (107)	3-3/4" (95)	Precision Ball	NS-03QDP-125-TL-____
3	1-1/4	QuikStart TPR	200	4-7/32" (107)	3-3/4" (95)	Plain	NS-03QDO-125-TL-____
3	1-1/4	Anti-Microbial TPR	200	4-7/32" (107)	3-3/4" (95)	Precision Ball	NS-03AMP-125-TL-____
4	1-1/4	QuikStart TPR	275	5-13/32" (137)	4-7/16" (112)	Precision Ball	NS-04QDP-125-TL-____
4	1-1/4	Anti-Microbial TPR	275	5-13/32" (137)	4-7/16" (112)	Precision Ball	NS-04AMP-125-TL-____
5	1-1/4	QuikStart TPR	325	6-1/2" (165)	4-7/16" (112)	Precision Ball	NS-05QDP-125-TL-____
5	1-1/4	Anti-Microbial TPR	325	6-1/2" (165)	4-7/16" (112)	Precision Ball	NS-05AMP-125-TL-____
6	1-1/4	QuikStart TPR	325	7-1/2" (191)	4-9/16" (116)	Precision Ball	NS-06QDP-125-TL-____
6	1-1/4	QuikStart TPR	325	7-1/2" (191)	4-9/16" (116)	Plain	NS-06QDO-125-TL-____
6	1-1/4	Anti-Microbial TPR	325	7-1/2" (191)	4-9/16" (116)	Precision Ball	NS-06AMP-125-TL-____



EXPANDING ADAPTER STEM DIRECTION LOCK MODELS (LOCKS SWIVEL ONLY)

Precision sealed ball bearing raceway design for smooth, quiet maintenance free ride.

Wheel Diameter (Inches)	Tread Width (Inches)	Wheel Description	Capacity (Lbs)	Load Height Inches (mm)	Swivel Radius Inches (mm)	Wheel Bearing	Model Number
3	1-1/4	QuikStart TPR	200	4-7/32" (107)	3-3/4" (95)	Precision Ball	NS-03QDP-125-DL-____
3	1-1/4	QuikStart TPR	200	4-7/32" (107)	3-3/4" (95)	Plain	NS-03QDO-125-DL-____
3	1-1/4	Anti-Microbial TPR	200	4-7/32" (107)	3-3/4" (95)	Precision Ball	NS-03AMP-125-DL-____
4	1-1/4	QuikStart TPR	275	5-13/32" (137)	4-7/16" (112)	Precision Ball	NS-04QDP-125-DL-____
4	1-1/4	Anti-Microbial TPR	275	5-13/32" (137)	4-7/16" (112)	Precision Ball	NS-04AMP-125-DL-____
5	1-1/4	QuikStart TPR	325	6-1/2" (165)	4-7/16" (112)	Precision Ball	NS-05QDP-125-DL-____
5	1-1/4	Anti-Microbial TPR	325	6-1/2" (165)	4-7/16" (112)	Precision Ball	NS-05AMP-125-DL-____
6	1-1/4	QuikStart TPR	325	7-1/2" (191)	4-9/16" (116)	Precision Ball	NS-06QDP-125-DL-____
6	1-1/4	QuikStart TPR	325	7-1/2" (191)	4-9/16" (116)	Plain	NS-06QDO-125-DL-____
6	1-1/4	Anti-Microbial TPR	325	7-1/2" (191)	4-9/16" (116)	Precision Ball	NS-06AMP-125-DL-____



Our Directional Lock casters are designed to lock the swivel but not the wheel allowing you to steer your equipment. The directional lock feature is designed to break free under heavier load when the unit is traversing a corner only to lock back into position when the unit resumes a straight course.

Consult factory for 3" diameter model expanding adapter stems.

Specify Expanding Adapter Stem Round Nylon (XRN) code, Round Zamac (XRZ). see fittings at left for dimensions:

EXPANDING ADAPTER STEM FITTINGS

See fittings page for more options.

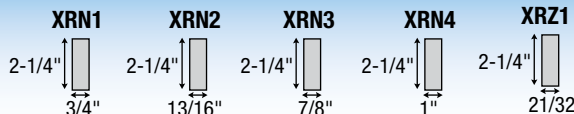

NYLON PLUS STAINLESS (NS)

THREADED STEM MODELS
FREE SWIVEL • TOTAL LOCK • DIRECTION LOCK



- APPLICATIONS**
- Food Service Equipment
 - Case Carts
 - Utility Carts
 - Medical Equipment
 - Institutional Equipment
 - Hospital Carts
 - Animal Cage Carts
 - Pharmaceutical Equipment

304 Stainless steel components!

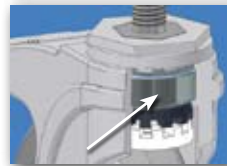

Precision sealed ball bearing raceway design for smooth, quiet maintenance free ride.

- FEATURES**
- Sealed stainless steel precision bearing raceway, smooth and quite
 - **Total lock and direction lock brake models available**
 - Wheels feature sealed stainless precision ball bearings and full thread guards
 - Resistant to most chemicals
 - Recessed Stainless axle with plastic cap covers
 - Maintenance free, requires no lubrication for rig or wheel

Our NS Series is similar to NG Series but with the added benefit of 304 stainless components making it excellent for wet environments.

THREADED STEM MODELS

Precision sealed ball bearing raceway design for smooth, quiet maintenance free ride.

Wheel Diameter (Inches)	Tread Width (Inches)	Wheel Description	Capacity (Lbs)	Load Height Inches (mm)	Swivel Radius Inches (mm)	Wheel Bearing	Model Number
3	1-1/4	QuikStart TPR	200	4-7/32" (107)	2-13/16" (72)	Precision Ball	NS-03QDP-125-SW-_____
3	1-1/4	QuikStart TPR	200	4-7/32" (107)	2-13/16" (72)	Plain	NS-03QDO-125-SW-_____
3	1-1/4	Anti-Microbial TPR	200	4-7/32" (107)	2-13/16" (72)	Precision Ball	NS-03AMP-125-SW-_____
4	1-1/4	QuikStart TPR	275	5-13/32" (137)	3-7/16" (87)	Precision Ball	NS-04QDP-125-SW-_____
4	1-1/4	Anti-Microbial TPR	275	5-13/32" (137)	3-7/16" (87)	Precision Ball	NS-04AMP-125-SW-_____
5	1-1/4	QuikStart TPR	325	6-1/2" (165)	4" (102)	Precision Ball	NS-05QDP-125-SW-_____
5	1-1/4	Anti-Microbial TPR	325	6-1/2" (165)	4" (102)	Precision Ball	NS-05AMP-125-SW-_____
6	1-1/4	QuikStart TPR	325	7-1/2" (191)	4-9/16" (116)	Precision Ball	NS-06QDP-125-SW-_____
6	1-1/4	QuikStart TPR	325	7-1/2" (191)	4-9/16" (116)	Plain	NS-06QDO-125-SW-_____
6	1-1/4	Anti-Microbial TPR	325	7-1/2" (191)	4-9/16" (116)	Precision Ball	NS-06AMP-125-SW-_____



316SS fittings available for non-magnetic applications. Consult factory.

THREADED STEM FITTINGS

Stainless steel. See fittings page for more options.

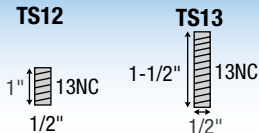

Specify Threaded Stem (TS) code, see fittings below for dimensions:



Custom Colors Available

NYLON PLUS STAINLESS (NS)

THREADED STEM MODELS
FREE SWIVEL • TOTAL LOCK • DIRECTION LOCK

THREADED STEM TOTAL LOCK MODELS (LOCKS WHEEL AND SWIVEL)

Precision sealed ball bearing raceway design for smooth, quiet maintenance free ride.

Wheel Diameter (Inches)	Tread Width (Inches)	Wheel Description	Capacity (Lbs)	Load Height Inches (mm)	Swivel Radius Inches (mm)	Wheel Bearing	Model Number
3	1-1/4	QuikStart TPR	200	4-7/32" (107)	3-3/4" (95)	Precision Ball	NS-03QDP-125-TL-____
3	1-1/4	QuikStart TPR	200	4-7/32" (107)	3-3/4" (95)	Plain	NS-03QDO-125-TL-____
3	1-1/4	Anti-Microbial TPR	200	4-7/32" (107)	3-3/4" (95)	Precision Ball	NS-03AMP-125-TL-____
4	1-1/4	QuikStart TPR	275	5-13/32" (137)	4-7/16" (112)	Precision Ball	NS-04QDP-125-TL-____
4	1-1/4	Anti-Microbial TPR	275	5-13/32" (137)	4-7/16" (112)	Precision Ball	NS-04AMP-125-TL-____
5	1-1/4	QuikStart TPR	325	6-1/2" (165)	4-7/16" (112)	Precision Ball	NS-05QDP-125-TL-____
5	1-1/4	Anti-Microbial TPR	325	6-1/2" (165)	4-7/16" (112)	Precision Ball	NS-05AMP-125-TL-____
6	1-1/4	QuikStart TPR	325	7-1/2" (191)	4-9/16" (116)	Precision Ball	NS-06QDP-125-TL-____
6	1-1/4	QuikStart TPR	325	7-1/2" (191)	4-9/16" (116)	Plain	NS-06QDO-125-TL-____
6	1-1/4	Anti-Microbial TPR	325	7-1/2" (191)	4-9/16" (116)	Precision Ball	NS-06AMP-125-TL-____



THREADED STEM DIRECTION LOCK MODELS (LOCKS SWIVEL ONLY)

Precision sealed ball bearing raceway design for smooth, quiet maintenance free ride.

Wheel Diameter (Inches)	Tread Width (Inches)	Wheel Description	Capacity (Lbs)	Load Height Inches (mm)	Swivel Radius Inches (mm)	Wheel Bearing	Model Number
3	1-1/4	QuikStart TPR	200	4-7/32" (107)	3-3/4" (95)	Precision Ball	NS-03QDP-125-DL-____
3	1-1/4	QuikStart TPR	200	4-7/32" (107)	3-3/4" (95)	Plain	NS-03QDO-125-DL-____
3	1-1/4	Anti-Microbial TPR	200	4-7/32" (107)	3-3/4" (95)	Precision Ball	NS-03AMP-125-DL-____
4	1-1/4	QuikStart TPR	275	5-13/32" (137)	4-7/16" (112)	Precision Ball	NS-04QDP-125-DL-____
4	1-1/4	Anti-Microbial TPR	275	5-13/32" (137)	4-7/16" (112)	Precision Ball	NS-04AMP-125-DL-____
5	1-1/4	QuikStart TPR	325	6-1/2" (165)	4-7/16" (112)	Precision Ball	NS-05QDP-125-DL-____
5	1-1/4	Anti-Microbial TPR	325	6-1/2" (165)	4-7/16" (112)	Precision Ball	NS-05AMP-125-DL-____
6	1-1/4	QuikStart TPR	325	7-1/2" (191)	4-9/16" (116)	Precision Ball	NS-06QDP-125-DL-____
6	1-1/4	QuikStart TPR	325	7-1/2" (191)	4-9/16" (116)	Plain	NS-06QDO-125-DL-____
6	1-1/4	Anti-Microbial TPR	325	7-1/2" (191)	4-9/16" (116)	Precision Ball	NS-06AMP-125-DL-____



Our Directional Lock casters are designed to lock the swivel but not the wheel allowing you to steer your equipment. The directional lock feature is designed to break free under heavier load when the unit is traversing a corner only to lock back into position when the unit resumes a straight course.

Specify Threaded Stem (TS) code, see fittings below for dimensions:

THREADED STEM FITTINGS

Stainless steel.
See fittings page for more options.

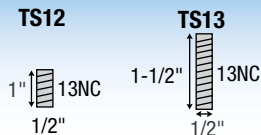

MARQUEE (MQ)

TOP PLATE MODELS

FREE SWIVEL • TOTAL LOCK • DIRECTION LOCK

NEW



- APPLICATIONS**
- Food Service Equipment
 - Case Carts
 - Utility Carts
 - Medical Equipment
 - Institutional Equipment
 - Hospital Carts
 - Animal Cage Carts
 - Pharmaceutical Equipment

- FEATURES**
- Glass filled nylon body
 - Dual ball bearing raceway
 - **Total lock and direction lock brake models available**
 - Resistant to water and most chemicals
 - Precision bearing in wheel
 - Zinc plated top plate
 - Riveted axle
 - Standard color is light gray with white strip and white wheel core

Our MQ Series features attractive two-tone accents.



Custom Colors Available

SWIVEL TOP PLATE MODELS

Wheel Diameter (Inches)	Tread Width (Inches)	Wheel Description	Capacity (Lbs)	Load Height Inches (mm)	Swivel Radius Inches (mm)	Wheel Bearing	Model Number
4	1-1/4	Thermoplastic	200	5-5/8" (142)	3-1/2" (90)	Precision Ball	MQ-04TPP-125-SW-TP01
4	1-1/4	Polyurethane TPU	225	5-5/8" (142)	3-1/2" (90)	Precision Ball	MQ-04PYP-125-SW-TP01
5	1-1/4	Thermoplastic	250	6-3/4" (171)	4" (100)	Precision Ball	MQ-05TPP-125-SW-TP01
5	1-1/4	Polyurethane TPU	275	6-3/4" (171)	4" (100)	Precision Ball	MQ-05PYP-125-SW-TP01



TOP PLATE FITTING

Swivel Top Plate Pattern

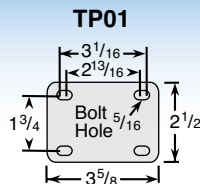

MARQUEE (MQ)

TOP PLATE MODELS

FREE SWIVEL • TOTAL LOCK • DIRECTION LOCK

SWIVEL TOP PLATE TOTAL LOCK MODELS

(LOCKS WHEEL AND SWIVEL)

Wheel Diameter (Inches)	Tread Width (Inches)	Wheel Description	Capacity (Lbs)	Load Height Inches (mm)	Swivel Radius Inches (mm)	Wheel Bearing	Model Number
4	1-1/4	Thermoplastic	200	5-5/8" (142)	3-1/2" (90)	Precision Ball	MQ-04TPP-125-TL-TP01
4	1-1/4	Polyurethane TPU	225	5-5/8" (142)	3-1/2" (90)	Precision Ball	MQ-04PYP-125-TL-TP01
5	1-1/4	Thermoplastic	250	6-3/4" (171)	4" (100)	Precision Ball	MQ-05TPP-125-TL-TP01
5	1-1/4	Polyurethane TPU	275	6-3/4" (171)	4" (100)	Precision Ball	MQ-05PYP-125-TL-TP01



SWIVEL TOP PLATE DIRECTION LOCK MODELS

(LOCKS SWIVEL ONLY)

Wheel Diameter (Inches)	Tread Width (Inches)	Wheel Description	Capacity (Lbs)	Load Height Inches (mm)	Swivel Radius Inches (mm)	Wheel Bearing	Model Number
4	1-1/4	Thermoplastic	200	5-5/8" (142)	3-1/2" (90)	Precision Ball	MQ-04TPP-125-DL-TP01
4	1-1/4	Polyurethane TPU	225	5-5/8" (142)	3-1/2" (90)	Precision Ball	MQ-04PYP-125-DL-TP01
5	1-1/4	Thermoplastic	250	6-3/4" (171)	4" (100)	Precision Ball	MQ-05TPP-125-DL-TP01
5	1-1/4	Polyurethane TPU	275	6-3/4" (171)	4" (100)	Precision Ball	MQ-05PYP-125-DL-TP01



TOP PLATE FITTING

Swivel Top Plate Pattern

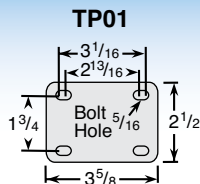

MARQUEE (MQ)

GRIP RING STEM MODELS

FREE SWIVEL • TOTAL LOCK • DIRECTION LOCK

NEW

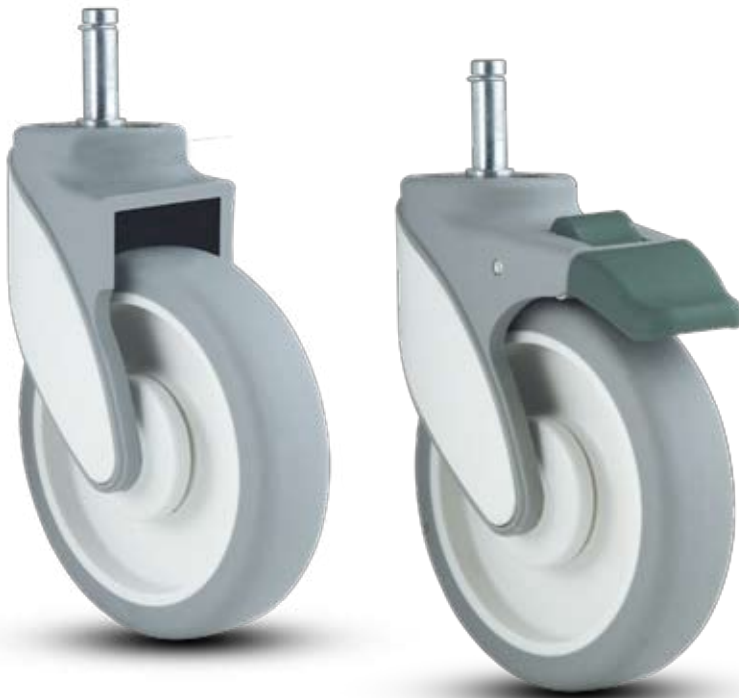

- APPLICATIONS**
- Food Service Equipment
 - Case Carts
 - Utility Carts
 - Medical Equipment
 - Institutional Equipment
 - Hospital Carts
 - Animal Cage Carts
 - Pharmaceutical Equipment

- FEATURES**
- Glass filled nylon body
 - Dual ball bearing raceway
 - **Total lock and direction lock brake models available**
 - Resistant to water and most chemicals
 - Precision bearing in wheel
 - Zinc plated top plate
 - Riveted axle
 - Standard color is light gray with white strip and white wheel core

Our MQ Series features attractive two-tone accents.



Custom Colors Available

GRIP RING STEM MODELS

Precision sealed ball bearing raceway design for smooth, quiet maintenance free ride.

Wheel Diameter (Inches)	Tread Width (Inches)	Wheel Description	Capacity (Lbs)	Load Height Inches (mm)	Swivel Radius Inches (mm)	Wheel Bearing	Model Number
4	1-1/4	Thermoplastic	200	5-1/2" (139)	3-1/2" (90)	Precision Ball	MQ-04TPP-125-SW-____
4	1-1/4	Polyurethane TPU	225	5-1/2" (139)	3-1/2" (90)	Precision Ball	MQ-04PYP-125-SW-____
5	1-1/4	Thermoplastic	250	6-5/8" (168)	4" (100)	Precision Ball	MQ-05TPP-125-SW-____
5	1-1/4	Polyurethane TPU	275	6-5/8" (168)	4" (100)	Precision Ball	MQ-05PYP-125-SW-____



Specify Grip Ring Stem (GR) code, see fittings below for dimensions:

GRIP RING STEM FITTINGS

See fittings page for more options.

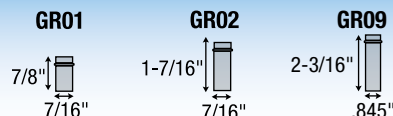

MARQUEE (MQ)

TOP PLATE MODELS

FREE SWIVEL • TOTAL LOCK • DIRECTION LOCK

GRIP RING STEM TOTAL LOCK MODELS

(LOCKS WHEEL AND SWIVEL)

Wheel Diameter (Inches)	Tread Width (Inches)	Wheel Description	Capacity (Lbs)	Load Height Inches (mm)	Swivel Radius Inches (mm)	Wheel Bearing	Model Number
4	1-1/4	Thermoplastic	200	5-1/2" (139)	3-1/2" (90)	Precision Ball	MQ-04TPP-125-TL-____
4	1-1/4	Polyurethane TPU	225	5-1/2" (139)	3-1/2" (90)	Precision Ball	MQ-04PYP-125-TL-____
5	1-1/4	Thermoplastic	250	6-5/8" (168)	4" (100)	Precision Ball	MQ-05TPP-125-TL-____
5	1-1/4	Polyurethane TPU	275	6-5/8" (168)	4" (100)	Precision Ball	MQ-05PYP-125-TL-____



GRIP RING STEM DIRECTION LOCK MODELS

(LOCKS SWIVEL ONLY)

Wheel Diameter (Inches)	Tread Width (Inches)	Wheel Description	Capacity (Lbs)	Load Height Inches (mm)	Swivel Radius Inches (mm)	Wheel Bearing	Model Number
4	1-1/4	Thermoplastic	200	5-1/2" (139)	3-1/2" (90)	Precision Ball	MQ-04TPP-125-DL-____
4	1-1/4	Polyurethane TPU	225	5-1/2" (139)	3-1/2" (90)	Precision Ball	MQ-04PYP-125-DL-____
5	1-1/4	Thermoplastic	250	6-5/8" (168)	4" (100)	Precision Ball	MQ-05TPP-125-DL-____
5	1-1/4	Polyurethane TPU	275	6-5/8" (168)	4" (100)	Precision Ball	MQ-05PYP-125-DL-____



Specify Grip Ring Stem (GR) code, see fittings below for dimensions:

GRIP RING STEM FITTINGS

See fittings page for more options.



MARQUEE (MQ)

THREADED STEM MODELS

FREE SWIVEL • TOTAL LOCK • DIRECTION LOCK

NEW



- APPLICATIONS**
- Food Service Equipment
 - Case Carts
 - Utility Carts
 - Medical Equipment
 - Institutional Equipment
 - Hospital Carts
 - Animal Cage Carts
 - Pharmaceutical Equipment

- FEATURES**
- Glass filled nylon body
 - Dual ball bearing raceway
 - **Total lock and direction lock brake models available**
 - Resistant to water and most chemicals
 - Precision bearing in wheel
 - Zinc plated top plate
 - Riveted axle
 - Standard color is light gray with white strip and white wheel core

Our MQ Series features attractive two-tone accents.



Custom Colors Available

THREADED STEM MODELS

Precision sealed ball bearing raceway design for smooth, quiet maintenance free ride.

Wheel Diameter (Inches)	Tread Width (Inches)	Wheel Description	Capacity (Lbs)	Load Height Inches (mm)	Swivel Radius Inches (mm)	Wheel Bearing	Model Number
4	1-1/4	Thermoplastic	200	5-1/2" (139)	3-1/2" (90)	Precision Ball	MQ-04TPP-125-SW-____
4	1-1/4	Polyurethane TPU	225	5-1/2" (139)	3-1/2" (90)	Precision Ball	MQ-04PYP-125-SW-____
5	1-1/4	Thermoplastic	250	6-5/8" (168)	4" (100)	Precision Ball	MQ-05TPP-125-SW-____
5	1-1/4	Polyurethane TPU	275	6-5/8" (168)	4" (100)	Precision Ball	MQ-05PYP-125-SW-____



Specify Threaded Stem (TS) code, see fittings below for dimensions:

THREADED STEM FITTINGS

See fittings page for more options.

TS02



TS03



MARQUEE (MQ)

TOP PLATE MODELS

FREE SWIVEL • TOTAL LOCK • DIRECTION LOCK

THREADED STEM TOTAL LOCK MODELS

(LOCKS WHEEL AND SWIVEL)

Wheel Diameter (Inches)	Tread Width (Inches)	Wheel Description	Capacity (Lbs)	Load Height Inches (mm)	Swivel Radius Inches (mm)	Wheel Bearing	Model Number
4	1-1/4	Thermoplastic	200	5-1/2" (139)	3-1/2" (90)	Precision Ball	MQ-04TPP-125-TL-____
4	1-1/4	Polyurethane TPU	225	5-1/2" (139)	3-1/2" (90)	Precision Ball	MQ-04PYP-125-TL-____
5	1-1/4	Thermoplastic	250	6-5/8" (168)	4" (100)	Precision Ball	MQ-05TPP-125-TL-____
5	1-1/4	Polyurethane TPU	275	6-5/8" (168)	4" (100)	Precision Ball	MQ-05PYP-125-TL-____



THREADED STEM DIRECTION LOCK MODELS

(LOCKS SWIVEL ONLY)

Wheel Diameter (Inches)	Tread Width (Inches)	Wheel Description	Capacity (Lbs)	Load Height Inches (mm)	Swivel Radius Inches (mm)	Wheel Bearing	Model Number
4	1-1/4	Thermoplastic	200	5-1/2" (139)	3-1/2" (90)	Precision Ball	MQ-04TPP-125-DL-____
4	1-1/4	Polyurethane TPU	225	5-1/2" (139)	3-1/2" (90)	Precision Ball	MQ-04PYP-125-DL-____
5	1-1/4	Thermoplastic	250	6-5/8" (168)	4" (100)	Precision Ball	MQ-05TPP-125-DL-____
5	1-1/4	Polyurethane TPU	275	6-5/8" (168)	4" (100)	Precision Ball	MQ-05PYP-125-DL-____



Specify Threaded Stem (TS) code, see fittings below for dimensions:

THREADED STEM FITTINGS

See fittings page for more options.

TS02

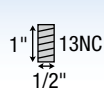

TS03

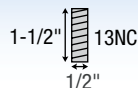

PLASTIC (PG)

TOP PLATE MODELS

FREE SWIVEL • TOTAL LOCK • DIRECTION LOCK



Standard color is silk grey

APPLICATIONS

- Food Service Equipment
- Case Carts
- Utility Carts
- Medical Equipment
- Institutional Equipment
- Hospital Carts
- Animal Cage Carts
- Cart Washable applications

4", 5", 6" & 8" wheel diameters

FEATURES

- Maintenance free
- Sealed precision bearing raceway
- Total Lock Brake models lock both swivel and wheel
- Directional lock models lock swivel only (helps with steering)
- Wheel feature precision bearings and full thread guards
- Rigs are made with glass filled nylon for added strength
- Resistance to most chemicals
- Recessed axle with plastic cap covers
- Operating temperatures good to 210° F intermittent

Our PG series provides you with that smooth European look and design.

SWIVEL TOP PLATE MODELS

Wheel Diameter (Inches)	Tread Width (Inches)	Wheel Description	Capacity (Lbs)	Load Height Inches (mm)	Swivel Radius Inches (mm)	Wheel Bearing	Model Number
4	1-1/4	Rubber on Plastic	220	5-13/16" (148)	3-15/32" (88)	Precision Ball	PG-04RPP-125-SW-TP01
4	1-1/4	Polyurethane TPU	220	5-13/16" (148)	3-15/32" (88)	Precision Ball	PG-04PYP-125-SW-TP01
5	1-1/4	Rubber on Plastic	220	6-39/64" (168)	4-5/6" (110)	Precision Ball	PG-05RPP-125-SW-TP01
5	1-1/4	Polyurethane TPU	220	6-39/64" (168)	4-5/6" (110)	Precision Ball	PG-05PYP-125-SW-TP01
6	1-1/4	Rubber on Plastic	264	7-25/32" (198)	4-57/64" (124)	Precision Ball	PG-06RPP-125-SW-TP01
6	1-1/4	Polyurethane TPU	264	7-25/32" (198)	4-57/64" (124)	Precision Ball	PG-06PYP-125-SW-TP01
8	1-1/4	Rubber on Plastic	264	10" (254)	6-1/2" (165)	Precision Ball	PG-08RPP-125-SW-TP01
8	1-1/4	Polyurethane TPU	264	10" (254)	6-1/2" (165)	Precision Ball	PG-08PYP-125-SW-TP01



TOP PLATE FITTING

Swivel Top Plate Pattern

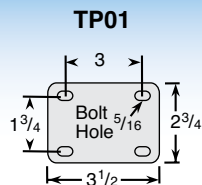

Dark grey also available on all PG models shown on pages 80-87. Change PG to PD (Example: PD-04RPP-SW-HKU1)



PLASTIC (PG)

TOP PLATE MODELS

FREE SWIVEL • TOTAL LOCK • DIRECTION LOCK

SWIVEL TOP PLATE TOTAL LOCK MODELS

(LOCKS WHEEL AND SWIVEL)

Wheel Diameter (Inches)	Tread Width (Inches)	Wheel Description	Capacity (lbs)	Load Height Inches (mm)	Swivel Radius Inches (mm)	Wheel Bearing	Model Number
4	1-1/4	Rubber on Plastic	220	5-13/16" (148)	4-21/64" (110)	Precision Ball	PG-04RPP-125-TW-TP01
4	1-1/4	Polyurethane TPU	220	5-13/16" (148)	4-21/64" (110)	Precision Ball	PG-04PYP-125-TW-TP01
5	1-1/4	Rubber on Plastic	220	6-39/64" (168)	4-23/32" (120)	Precision Ball	PG-05RPP-125-TW-TP01
5	1-1/4	Polyurethane TPU	220	6-39/64" (168)	4-23/32" (120)	Precision Ball	PG-05PYP-125-TW-TP01
6	1-1/4	Rubber on Plastic	264	7-25/32" (198)	5-9/32" (134)	Precision Ball	PG-06RPP-125-TW-TP01
6	1-1/4	Polyurethane TPU	264	7-25/32" (198)	5-9/32" (134)	Precision Ball	PG-06PYP-125-TW-TP01
8	1-1/4	Rubber on Plastic	264	10" (254)	5-29/32" (150)	Precision Ball	PG-08RPP-125-TW-TP01
8	1-1/4	Polyurethane TPU	264	10" (254)	5-29/32" (150)	Precision Ball	PG-08PYP-125-TW-TP01



SWIVEL TOP PLATE DIRECTION LOCK MODELS

(LOCKS SWIVEL ONLY)

Wheel Diameter (Inches)	Tread Width (Inches)	Wheel Description	Capacity (lbs)	Load Height Inches (mm)	Swivel Radius Inches (mm)	Wheel Bearing	Model Number
4	1-1/4	Rubber on Plastic	220	5-13/16" (148)	4-21/64" (110)	Precision Ball	PG-04RPP-125-DL-TP01
4	1-1/4	Polyurethane TPU	220	5-13/16" (148)	4-21/64" (110)	Precision Ball	PG-04PYP-125-DL-TP01
5	1-1/4	Rubber on Plastic	220	6-39/64" (168)	4-23/32" (120)	Precision Ball	PG-05RPP-125-DL-TP01
5	1-1/4	Polyurethane TPU	220	6-39/64" (168)	4-23/32" (120)	Precision Ball	PG-05PYP-125-DL-TP01
6	1-1/4	Rubber on Plastic	264	7-25/32" (198)	5-9/32" (134)	Precision Ball	PG-06RPP-125-DL-TP01
6	1-1/4	Polyurethane TPU	264	7-25/32" (198)	5-9/32" (134)	Precision Ball	PG-06PYP-125-DL-TP01
8	1-1/4	Rubber on Plastic	264	10" (254)	5-29/32" (150)	Precision Ball	PG-08RPP-125-DL-TP01
8	1-1/4	Polyurethane TPU	264	10" (254)	5-29/32" (150)	Precision Ball	PG-08PYP-125-DL-TP01



Our Directional Lock casters are designed to lock the swivel but not the wheel allowing you to steer your equipment. The directional lock feature is designed to break free under heavier load when the unit is traversing a corner only to lock back into position when the unit resumes a straight course.

TOP PLATE FITTING

Swivel Top Plate Pattern

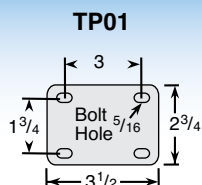

PLASTIC (PG)

HOLLOW KINGPIN MODELS

FREE SWIVEL • TOTAL LOCK • DIRECTION LOCK

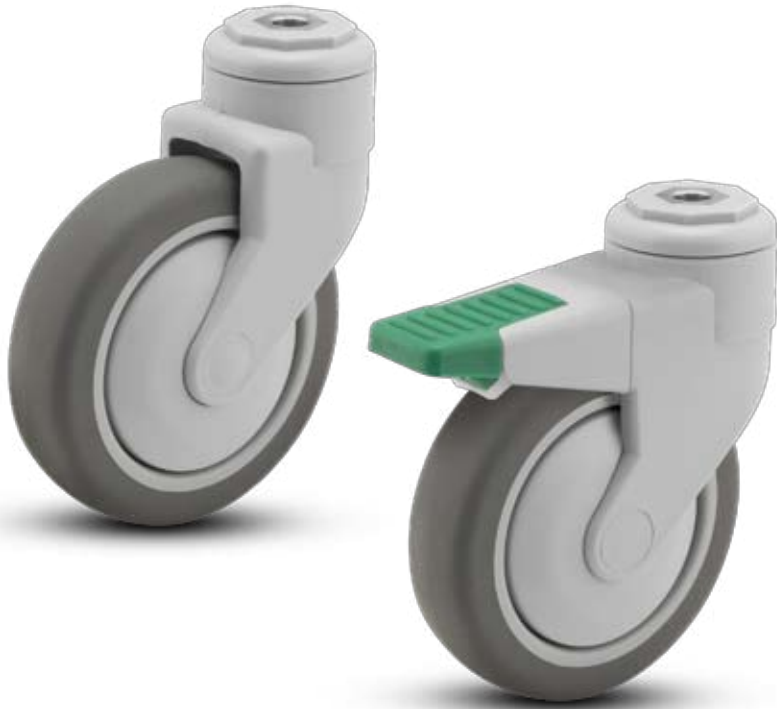

APPLICATIONS

- Food Service Equipment
- Case Carts
- Utility Carts
- Medical Equipment
- Institutional Equipment
- Hospital Carts
- Animal Cage Carts
- Cart Washable applications

4", 5", 6" & 8" wheel diameters

FEATURES

- Maintenance free
- Sealed precision bearing raceway
- Total Lock Brake models lock both swivel and wheel
- Directional lock models lock swivel only (helps with steering)
- Wheel feature precision bearings and full thread guards
- Rigs are made with glass filled nylon for added strength
- Resistance to most chemicals
- Recessed axle with plastic cap covers
- Operating temperatures good to 210° F intermittent

Our PG series provides you with that smooth European look and design.

HOLLOW KINGPIN MODELS

Wheel Diameter (Inches)	Tread Width (Inches)	Wheel Description	Capacity (Lbs)	Load Height Inches (mm)	Swivel Radius Inches (mm)	Wheel Bearing	Model Number
4	1-1/4	Rubber on Plastic	220	5-45/64" (145)	3-15/32" (88)	Precision Ball	PG-04RPP-125-SW-HKU1
4	1-1/4	Polyurethane TPU	220	5-45/64" (145)	3-15/32" (88)	Precision Ball	PG-04PYP-125-SW-HKU1
5	1-1/4	Rubber on Plastic	220	6-1/2" (165)	4-5/6" (110)	Precision Ball	PG-05RPP-125-SW-HKU1
5	1-1/4	Polyurethane TPU	220	6-1/2" (165)	4-5/6" (110)	Precision Ball	PG-05PYP-125-SW-HKU1
6	1-1/4	Rubber on Plastic	264	7-11/16" (195)	4-57/64" (124)	Precision Ball	PG-06RPP-125-SW-HKU1
6	1-1/4	Polyurethane TPU	264	7-11/16" (195)	4-57/64" (124)	Precision Ball	PG-06PYP-125-SW-HKU1
8	1-1/4	Rubber on Plastic	264	9-7/8" (251)	6-1/2" (165)	Precision Ball	PG-08RPP-125-SW-HKU1
8	1-1/4	Polyurethane TPU	264	9-7/8" (251)	6-1/2" (165)	Precision Ball	PG-08PYP-125-SW-HKU1



HOLLOW KINGPIN

Caster is provided unassembled to make it easy to add your choice of fitting. If you would like these assembled change from HKU1 to HKO1. 1/2 I.D.

Please see fitting pages for stems that can be added to this series.



PLASTIC (PG)

HOLLOW KINGPIN MODELS

FREE SWIVEL • TOTAL LOCK • DIRECTION LOCK

HOLLOW KINGPIN TOTAL LOCK MODELS

(LOCKS WHEEL AND SWIVEL)

Wheel Diameter (Inches)	Tread Width (Inches)	Wheel Description	Capacity (lbs)	Load Height Inches (mm)	Swivel Radius Inches (mm)	Wheel Bearing	Model Number
4	1-1/4	Rubber on Plastic	220	5-45/64" (145)	4-21/64" (110)	Precision Ball	PG-04RPP-125-TL-HKU1
4	1-1/4	Polyurethane TPU	220	5-45/64" (145)	4-21/64" (110)	Precision Ball	PG-04PYP-125-TL-HKU1
5	1-1/4	Rubber on Plastic	220	6-1/2" (165)	4-23/32" (120)	Precision Ball	PG-05RPP-125-TL-HKU1
5	1-1/4	Polyurethane TPU	220	6-1/2" (165)	4-23/32" (120)	Precision Ball	PG-05PYP-125-TL-HKU1
6	1-1/4	Rubber on Plastic	264	7-11/16" (195)	5-9/32" (134)	Precision Ball	PG-06RPP-125-TL-HKU1
6	1-1/4	Polyurethane TPU	264	7-11/16" (195)	5-9/32" (134)	Precision Ball	PG-06PYP-125-TL-HKU1
8	1-1/4	Rubber on Plastic	264	9-7/8" (251)	5-29/32" (150)	Precision Ball	PG-08RPP-125-TL-HKU1
8	1-1/4	Polyurethane TPU	264	9-7/8" (251)	5-29/32" (150)	Precision Ball	PG-08PYP-125-TL-HKU1



HOLLOW KINGPIN DIRECTION LOCK MODELS

(LOCKS SWIVEL ONLY)

Wheel Diameter (Inches)	Tread Width (Inches)	Wheel Description	Capacity (lbs)	Load Height Inches (mm)	Swivel Radius Inches (mm)	Wheel Bearing	Model Number
4	1-1/4	Rubber on Plastic	220	5-45/64" (145)	4-21/64" (110)	Precision Ball	PG-04RPP-125-DL-HKU1
4	1-1/4	Polyurethane TPU	220	5-45/64" (145)	4-21/64" (110)	Precision Ball	PG-04PYP-125-DL-HKU1
5	1-1/4	Rubber on Plastic	220	6-1/2" (165)	4-23/32" (120)	Precision Ball	PG-05RPP-125-DL-HKU1
5	1-1/4	Polyurethane TPU	220	6-1/2" (165)	4-23/32" (120)	Precision Ball	PG-05PYP-125-DL-HKU1
6	1-1/4	Rubber on Plastic	264	7-11/16" (195)	5-9/32" (134)	Precision Ball	PG-06RPP-125-DL-HKU1
6	1-1/4	Polyurethane TPU	264	7-11/16" (195)	5-9/32" (134)	Precision Ball	PG-06PYP-125-DL-HKU1
8	1-1/4	Rubber on Plastic	264	9-7/8" (251)	5-29/32" (150)	Precision Ball	PG-08RPP-125-DL-HKU1
8	1-1/4	Polyurethane TPU	264	9-7/8" (251)	5-29/32" (150)	Precision Ball	PG-08PYP-125-DL-HKU1



Our Directional Lock casters are designed to lock the swivel but not the wheel allowing you to steer your equipment. The directional lock feature is designed to break free under heavier load when the unit is traversing a corner only to lock back into position when the unit resumes a straight course.

HOLLOW KINGPIN

Caster is provided unassembled to make it easy to add your choice of fitting. If you would like these assembled change from HKU1 to HK01. 1/2 I.D.

Please see fitting pages for stems that can be added to this series.



PLASTIC (PG)

GRIP RING STEM MODELS

FREE SWIVEL • TOTAL LOCK • DIRECTION LOCK

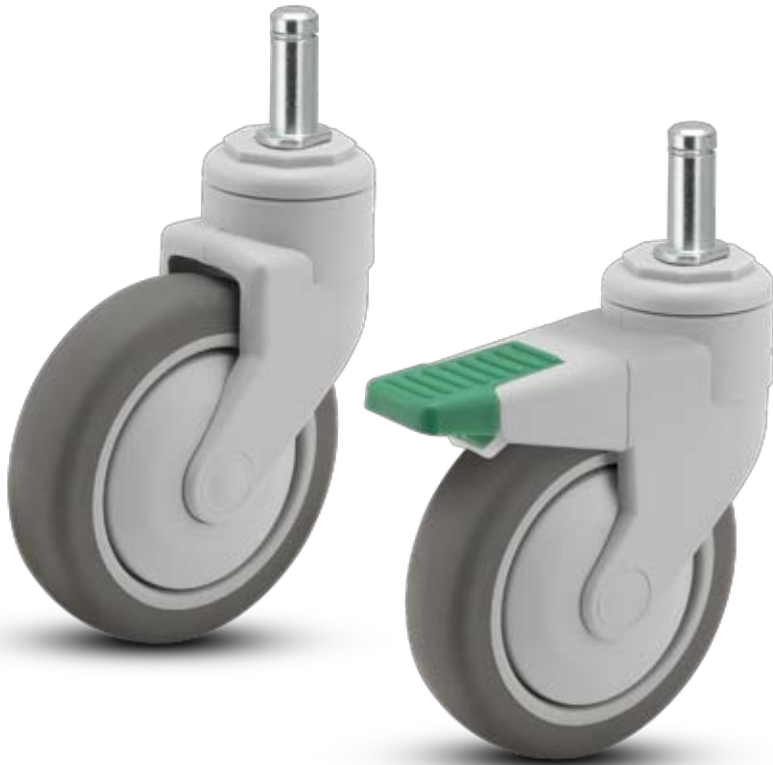

- APPLICATIONS**
- Food Service Equipment
 - Case Carts
 - Utility Carts
 - Medical Equipment
 - Institutional Equipment
 - Hospital Carts
 - Animal Cage Carts
 - Cart Washable applications

4", 5", 6" & 8" wheel diameters

- FEATURES**
- Maintenance free
 - Sealed precision bearing raceway
 - Total Lock Brake models lock both swivel and wheel
 - Directional lock models lock swivel only (helps with steering)
 - Wheel feature precision bearings and full thread guards
 - Rigs are made with glass filled nylon for added strength
 - Resistance to most chemicals
 - Recessed axle with plastic cap covers
 - Operating temperatures good to 210° F intermittent

Our PG series provides you with that smooth European look and design.

GRIP RING STEM MODELS

Wheel Diameter (Inches)	Tread Width (Inches)	Wheel Description	Capacity (Lbs)	Load Height Inches (mm)	Swivel Radius Inches (mm)	Wheel Bearing	Model Number
4	1-1/4	Rubber on Plastic	220	5-45/64" (145)	3-15/32" (88)	Precision Ball	PG-04RPP-125-SW-___
4	1-1/4	Polyurethane TPU	220	5-45/64" (145)	3-15/32" (88)	Precision Ball	PG-04PYP-125-SW-___
5	1-1/4	Rubber on Plastic	220	6-1/2" (165)	4-5/6" (110)	Precision Ball	PG-05RPP-125-SW-___
5	1-1/4	Polyurethane TPU	220	6-1/2" (165)	4-5/6" (110)	Precision Ball	PG-05PYP-125-SW-___
6	1-1/4	Rubber on Plastic	264	7-11/16" (195)	4-57/64" (124)	Precision Ball	PG-06RPP-125-SW-___
6	1-1/4	Polyurethane TPU	264	7-11/16" (195)	4-57/64" (124)	Precision Ball	PG-06PYP-125-SW-___
8	1-1/4	Rubber on Plastic	264	9-7/8" (251)	6-1/2" (165)	Precision Ball	PG-08RPP-125-SW-___
8	1-1/4	Polyurethane TPU	264	9-7/8" (251)	6-1/2" (165)	Precision Ball	PG-08PYP-125-SW-___



GRIP RING STEM FITTINGS

Easy to install grip rings snap into place. See fittings page for more options.

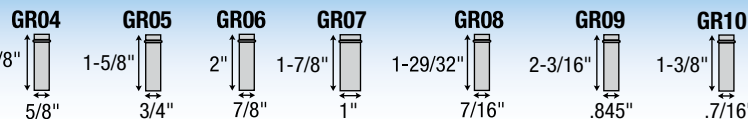

Specify Grip Ring Stem (GR) code, see fittings below for dimensions:

PLASTIC (PG)

GRIP RING STEM MODELS

FREE SWIVEL • TOTAL LOCK • DIRECTION LOCK

GRIP RING STEM TOTAL LOCK MODELS

(LOCKS WHEEL AND SWIVEL)

Wheel Diameter (Inches)	Tread Width (Inches)	Wheel Description	Capacity (lbs)	Load Height Inches (mm)	Swivel Radius Inches (mm)	Wheel Bearing	Model Number
4	1-1/4	Rubber on Plastic	220	5-45/64" (145)	4-21/64" (110)	Precision Ball	PG-04RPP-125-TL-___
4	1-1/4	Polyurethane TPU	220	5-45/64" (145)	4-21/64" (110)	Precision Ball	PG-04PYP-125-TL-___
5	1-1/4	Rubber on Plastic	220	6-1/2" (165)	4-23/32" (120)	Precision Ball	PG-05RPP-125-TL-___
5	1-1/4	Polyurethane TPU	220	6-1/2" (165)	4-23/32" (120)	Precision Ball	PG-05PYP-125-TL-___
6	1-1/4	Rubber on Plastic	264	7-11/16" (195)	5-9/32" (134)	Precision Ball	PG-06RPP-125-TL-___
6	1-1/4	Polyurethane TPU	264	7-11/16" (195)	5-9/32" (134)	Precision Ball	PG-06PYP-125-TL-___
8	1-1/4	Rubber on Plastic	264	9-7/8" (251)	5-29/32" (150)	Precision Ball	PG-08RPP-125-TL-___
8	1-1/4	Polyurethane TPU	264	9-7/8" (251)	5-29/32" (150)	Precision Ball	PG-08PYP-125-TL-___



GRIP RING STEM DIRECTION LOCK MODELS

(LOCKS SWIVEL ONLY)

Wheel Diameter (Inches)	Tread Width (Inches)	Wheel Description	Capacity (lbs)	Load Height Inches (mm)	Swivel Radius Inches (mm)	Wheel Bearing	Model Number
4	1-1/4	Rubber on Plastic	220	5-45/64" (145)	4-21/64" (110)	Precision Ball	PG-04RPP-125-DL-___
4	1-1/4	Polyurethane TPU	220	5-45/64" (145)	4-21/64" (110)	Precision Ball	PG-04PYP-125-DL-___
5	1-1/4	Rubber on Plastic	220	6-1/2" (165)	4-23/32" (120)	Precision Ball	PG-05RPP-125-DL-___
5	1-1/4	Polyurethane TPU	220	6-1/2" (165)	4-23/32" (120)	Precision Ball	PG-05PYP-125-DL-___
6	1-1/4	Rubber on Plastic	264	7-11/16" (195)	5-9/32" (134)	Precision Ball	PG-06RPP-125-DL-___
6	1-1/4	Polyurethane TPU	264	7-11/16" (195)	5-9/32" (134)	Precision Ball	PG-06PYP-125-DL-___
8	1-1/4	Rubber on Plastic	264	9-7/8" (251)	5-29/32" (150)	Precision Ball	PG-08RPP-125-DL-___
8	1-1/4	Polyurethane TPU	264	9-7/8" (251)	5-29/32" (150)	Precision Ball	PG-08PYP-125-DL-___



Our Directional Lock casters are designed to lock the swivel but not the wheel allowing you to steer your equipment. The directional lock feature is designed to break free under heavier load when the unit is traversing a corner only to lock back into position when the unit resumes a straight course.

GRIP RING STEM FITTINGS

Easy to install grip rings snap into place. See fittings page for more options.

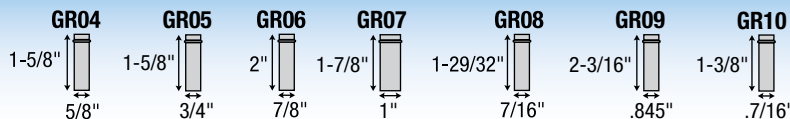

Specify Grip Ring Stem (GR) code, see fittings below for dimensions:

PLASTIC (PG)

THREADED STEM MODELS

FREE SWIVEL • TOTAL LOCK • DIRECTION LOCK



- APPLICATIONS**
- Food Service Equipment
 - Case Carts
 - Utility Carts
 - Medical Equipment
 - Institutional Equipment
 - Hospital Carts
 - Animal Cage Carts
 - Cart Washable applications

4", 5", 6" & 8" wheel diameters

- FEATURES**
- Maintenance free
 - Sealed precision bearing raceway
 - Total Lock Brake models lock both swivel and wheel
 - Directional lock models lock swivel only (helps with steering)
 - Wheel feature precision bearings and full thread guards
 - Rigs are made with glass filled nylon for added strength
 - Resistance to most chemicals
 - Recessed axle with plastic cap covers
 - Operating temperatures good to 210° F intermittent

Our PG series provides you with that smooth European look and design.

THREADED STEM MODELS

Wheel Diameter (Inches)	Tread Width (Inches)	Wheel Description	Capacity (lbs)	Load Height Inches (mm)	Swivel Radius Inches (mm)	Wheel Bearing	Model Number
4	1-1/4	Rubber on Plastic	220	5-45/64" (145)	3-15/32" (88)	Precision Ball	PG-04RPP-125-SW-___
4	1-1/4	Polyurethane TPU	220	5-45/64" (145)	3-15/32" (88)	Precision Ball	PG-04PYP-125-SW-___
5	1-1/4	Rubber on Plastic	220	6-1/2" (165)	4-5/6" (110)	Precision Ball	PG-05RPP-125-SW-___
5	1-1/4	Polyurethane TPU	220	6-1/2" (165)	4-5/6" (110)	Precision Ball	PG-05PYP-125-SW-___
6	1-1/4	Rubber on Plastic	264	7-11/16" (195)	4-57/64" (124)	Precision Ball	PG-06RPP-125-SW-___
6	1-1/4	Polyurethane TPU	264	7-11/16" (195)	4-57/64" (124)	Precision Ball	PG-06PYP-125-SW-___
8	1-1/4	Rubber on Plastic	264	9-7/8" (251)	6-1/2" (165)	Precision Ball	PG-08RPP-125-SW-___
8	1-1/4	Polyurethane TPU	264	9-7/8" (251)	6-1/2" (165)	Precision Ball	PG-08PYP-125-SW-___



THREADED STEM FITTINGS

Easy to install stem. See fittings page for more options.

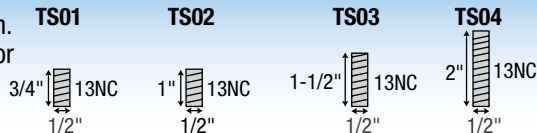

Specify Threaded Stem (TS) code, see fittings below for dimensions:

PLASTIC (PG)

THREADED STEM MODELS

FREE SWIVEL • TOTAL LOCK • DIRECTION LOCK

THREADED STEM TOTAL LOCK MODELS

(LOCKS WHEEL AND SWIVEL)

Wheel Diameter (Inches)	Tread Width (Inches)	Wheel Description	Capacity (Lbs)	Load Height Inches (mm)	Swivel Radius Inches (mm)	Wheel Bearing	Model Number
4	1-1/4	Rubber on Plastic	220	5-45/64" (145)	4-21/64" (110)	Precision Ball	PG-04RPP-125-TL-__
4	1-1/4	Polyurethane TPU	220	5-45/64" (145)	4-21/64" (110)	Precision Ball	PG-04PYP-125-TL-__
5	1-1/4	Rubber on Plastic	220	6-1/2" (165)	4-23/32" (120)	Precision Ball	PG-05RPP-125-TL-__
5	1-1/4	Polyurethane TPU	220	6-1/2" (165)	4-23/32" (120)	Precision Ball	PG-05PYP-125-TL-__
6	1-1/4	Rubber on Plastic	264	7-11/16" (195)	5-9/32" (134)	Precision Ball	PG-06RPP-125-TL-__
6	1-1/4	Polyurethane TPU	264	7-11/16" (195)	5-9/32" (134)	Precision Ball	PG-06PYP-125-TL-__
8	1-1/4	Rubber on Plastic	264	9-7/8" (251)	5-29/32" (150)	Precision Ball	PG-08RPP-125-TL-__
8	1-1/4	Polyurethane TPU	264	9-7/8" (251)	5-29/32" (150)	Precision Ball	PG-08PYP-125-TL-__



THREADED STEM DIRECTION LOCK MODELS

(LOCKS SWIVEL ONLY)

Wheel Diameter (Inches)	Tread Width (Inches)	Wheel Description	Capacity (Lbs)	Load Height Inches (mm)	Swivel Radius Inches (mm)	Wheel Bearing	Model Number
4	1-1/4	Rubber on Plastic	220	5-45/64" (145)	4-21/64" (110)	Precision Ball	PG-04RPP-125-DL-__
4	1-1/4	Polyurethane TPU	220	5-45/64" (145)	4-21/64" (110)	Precision Ball	PG-04PYP-125-DL-__
5	1-1/4	Rubber on Plastic	220	6-1/2" (165)	4-15/16" (125)	Precision Ball	PG-05RPP-125-DL-__
5	1-1/4	Polyurethane TPU	220	6-1/2" (165)	4-15/16" (125)	Precision Ball	PG-05PYP-125-DL-__
6	1-1/4	Rubber on Plastic	264	7-11/16" (195)	5-9/32" (134)	Precision Ball	PG-06RPP-125-DL-__
6	1-1/4	Polyurethane TPU	264	7-11/16" (195)	5-9/32" (134)	Precision Ball	PG-06PYP-125-DL-__
8	1-1/4	Rubber on Plastic	264	9-7/8" (251)	5-29/32" (150)	Precision Ball	PG-08RPP-125-DL-__
8	1-1/4	Polyurethane TPU	264	9-7/8" (251)	5-29/32" (150)	Precision Ball	PG-08PYP-125-DL-__



Our Directional Lock casters are designed to lock the swivel but not the wheel allowing you to steer your equipment. The directional lock feature is designed to break free under heavier load when the unit is traversing a corner only to lock back into position when the unit resumes a straight course.

THREADED STEM FITTINGS

Easy to install stem. See fittings page for more options.

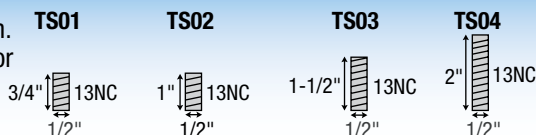

Specify Threaded Stem (TS) code, see fittings below for dimensions:

ANTISTATIC

Electronic equipment can be damaged by the electrostatic discharge of a simple human touch. Damage caused by this discharge is a very costly and frustrating to the medical industry. MedCaster antistatic casters and wheels can help minimize the risk of electrostatic discharge. Our casters and wheels conforms to CEN standards with resistance values < 10,000 ohms (measured at 500V DC, with minimum output of 50 V DC at 1,000 ohms resistance).

ANTISTATIC CHROME HOSPITAL (CH) & STAINLESS STEEL (SS)

Page 93



NYLON ANTISTATIC (NA)

Page 94



RHOMBUS 367 & 364 ANTISTATIC

Page 95



PLASTIC ANTISTATIC (PA)

Page 96-97



ANTISTATIC CHROME HOSPITAL (CH) AND STAINLESS STEEL (SS)

PLATE • HOLLOW RIVET • GRIP RING • THREADED • ROUND • SQUARE • SWIVEL TOTAL LOCK • DIRECTION LOCK



- APPLICATIONS**
- Food Service
 - Case Carts
 - Utility Carts
 - Hospital Equipment
 - Institutional Equipment
 - Store Fixtures
 - Medical equipment

- FEATURES**
- Chrome Plated Finish
 - Dual Ball Swivel Raceways for added strength
 - **Total Lock Brake** models lock both swivel and wheel
 - Directional lock models lock swivel only (helps with steering)
 - Precision ball bearings in wheels for easier rollability
 - Wheels have full thread guards for added protection

Antistatic models can help protect your equipment

FREE SWIVEL MODELS

Wheel Diameter (Inches)	Tread Width (Inches)	Wheel Description	Capacity (Lbs)	Load Height * Inches (mm)	Swivel Radius Inches (mm)	Wheel Bearing	Model Number
3	1-1/4	Conductive Rubber	190	4-7/16" (113)	2-29/32" (74)	Annular Ball	CH-03CRB-125-SW-___
4	1-1/4	Conductive Rubber	240	5-7/16" (138)	3-37/64" (91)	Annular Ball	CH-04CRB-125-SW-___
5	1-1/4	Conductive Rubber	260	6-7/16" (163)	4-7/32" (108)	Annular Ball	CH-05CRB-125-SW-___
6	1-1/4	Conductive Rubber	260	7-13/32" (188)	4-39/64 (117)	Annular Ball	CH-06CRB-125-SW-___



Rigid model change SW to RG

TOTAL LOCK MODELS

Wheel Diameter (Inches)	Tread Width (Inches)	Wheel Description	Capacity (Lbs)	Load Height * Inches (mm)	Swivel Radius Inches (mm)	Wheel Bearing	Model Number
3	1-1/4	Conductive Rubber	190	4-7/16" (113)	4-1/4" (108)	Annular Ball	CH-03CRB-125-TL-___
4	1-1/4	Conductive Rubber	240	5-7/16" (138)	4-35/64" (115)	Annular Ball	CH-04CRB-125-TL-___
5	1-1/4	Conductive Rubber	260	6-7/16" (163)	4-55/64" (123)	Annular Ball	CH-05CRB-125-TL-___
6	1-1/4	Conductive Rubber	260	7-13/32" (188)	4-55/64" (123)	Annular Ball	CH-06CRB-125-TL-___



Total Lock
Change "SW" to "TL". **Red** sticker on pedal.

SWIVEL LOCK MODELS MODELS

Wheel Diameter (Inches)	Tread Width (Inches)	Wheel Description	Capacity (Lbs)	Load Height * Inches (mm)	Swivel Radius Inches (mm)	Wheel Bearing	Model Number
3	1-1/4	Conductive Rubber	190	4-7/16" (113)	4-1/4" (108)	Annular Ball	CH-03CRB-125-DL-___
4	1-1/4	Conductive Rubber	240	5-7/16" (138)	4-35/64" (115)	Annular Ball	CH-04CRB-125-DL-___
5	1-1/4	Conductive Rubber	260	6-7/16" (163)	4-55/64" (123)	Annular Ball	CH-05CRB-125-DL-___
6	1-1/4	Conductive Rubber	260	7-13/32" (188)	4-55/64" (123)	Annular Ball	CH-06CRB-125-DL-___



Direction Lock
Change "SW" to "DL". **Green** sticker on pedal.

*For non-plate models subtract approximately 1/8" from load height.

For stainless steel models change "CH" to "SS"

Specify Fitting code

FITTING OPTIONS

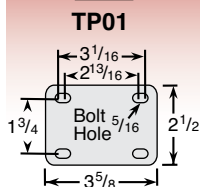

Hollow Rivet
HKU1 unassembled
HKO1 assembled
1/2 I.D.

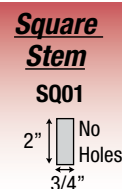
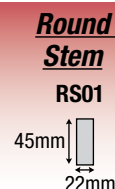
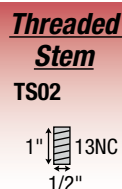
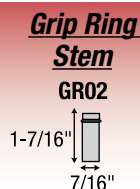

See more fitting options on page 4 and 5.

NEXT GENERATION NYLON ANTISTATIC (NA)

PLATE • HOLLOW RIVET • GRIP RING • THREADED
FREE SWIVEL • TOTAL LOCK • DIRECTION LOCK



- APPLICATIONS**
- Food Service
 - Case Carts
 - Utility Carts
 - Hospital Equipment
 - Institutional Equipment
 - Store Fixtures
 - Medical equipment

Precision sealed ball bearing raceway design for smooth, quiet maintenance free ride.

- FEATURES**
- Chrome Plated Finish
 - Dual Ball Swivel Raceways for added strength
 - **Total Lock Brake** models lock both swivel and wheel
 - Directional lock models lock swivel only (helps with steering)
 - Precision ball bearings in wheels for easier rollability
 - Wheels have full thread guards for added protection

Antistatic models can help protect your equipment

FREE SWIVEL MODELS

Wheel Diameter (Inches)	Tread Width (Inches)	Wheel Description	Capacity (Lbs)	Load Height Inches (mm)*	Swivel Radius Inches (mm)	Wheel Bearing	Model Number
3	1-1/4	QuikStart TPR	180	4-1/4" (108)	2-13/16" (72)	Precision Ball	NA-03QDP-125-SW-__
4	1-1/4	QuikStart TPR	220	5-3/4" (146)	3-7/16" (87)	Precision Ball	NA-04QDP-125-SW-__
5	1-1/4	QuikStart TPR	240	6-7/8" (174)	4" (102)	Precision Ball	NA-05QDP-125-SW-__
6	1-1/4	QuikStart TPR	264	7-11/16" (195)	4-9/16" (116)	Precision Ball	NA-06QDP-125-SW-__



Rigid models available. Change SW to RG.

TOTAL LOCK MODELS (LOCKS WHEEL AND SWIVEL)

Wheel Diameter (Inches)	Tread Width (Inches)	Wheel Description	Capacity (Lbs)	Load Height Inches (mm)*	Swivel Radius Inches (mm)	Wheel Bearing	Model Number
3	1-1/4	QuikStart TPR	180	4-1/4" (108)	3-3/4" (95)	Precision Ball	NA-03QDP-125-TL-__
4	1-1/4	QuikStart TPR	220	5-3/4" (146)	4-7/16" (112)	Precision Ball	NA-04QDP-125-TL-__
5	1-1/4	QuikStart TPR	240	6-7/8" (174)	4-7/16" (112)	Precision Ball	NA-05QDP-125-TL-__
6	1-1/4	QuikStart TPR	264	7-11/16" (195)	4-9/16" (116)	Precision Ball	NA-06QDP-125-TL-__



DIRECTION LOCK MODELS (LOCKS WHEEL AND SWIVEL)

Wheel Diameter (Inches)	Tread Width (Inches)	Wheel Description	Capacity (Lbs)	Load Height Inches (mm)*	Swivel Radius Inches (mm)	Wheel Bearing	Model Number
3	1-1/4	QuikStart TPR	180	4-1/4" (108)	3-3/4" (95)	Precision Ball	NA-03QDP-125-DL-__
4	1-1/4	QuikStart TPR	220	5-3/4" (146)	4-7/16" (112)	Precision Ball	NA-04QDP-125-DL-__
5	1-1/4	QuikStart TPR	240	6-7/8" (174)	4-7/16" (112)	Precision Ball	NA-05QDP-125-DL-__
6	1-1/4	QuikStart TPR	264	7-11/16" (195)	4-9/16" (116)	Precision Ball	NA-06QDP-125-DL-__

New rigid brake models now available on 5" models. Change TL to RB

*For non-plate models subtract approximately 1/8" from load height.

Specify Fitting code ↑

FITTING OPTIONS

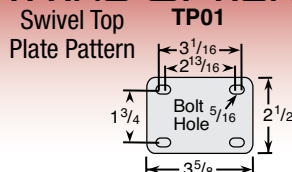

Hollow Rivet

HKU1 unassembled
HKO1 assembled
1/2 I.D.

Grip Ring Stem

GR01

7/8"
7/16"

GR02

1-7/16"
7/16"

GR09

2-3/16"
.845"

Threaded Stem

TS02

1"
13NC
1/2"

TS03

1-1/2"
13NC
1/2"

Other fittings available such as RS01, RS03, SQ01 and SQ03. See page 4-5 for more options.

RHOMBUS



367 & 364 ANTISTATIC



367A Swivel
364A Rigid

NEW



32C black antistatic wheel shown

- APPLICATIONS**
- Care beds
 - Medical-technical equipment
 - Physical therapy equipment
 - Rehab apparatus

- FEATURES**
- Antistatic caster
 - Stamped and drawn horn assembly
 - Zinc-plated
 - Double ball raceway that's sealed

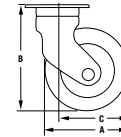
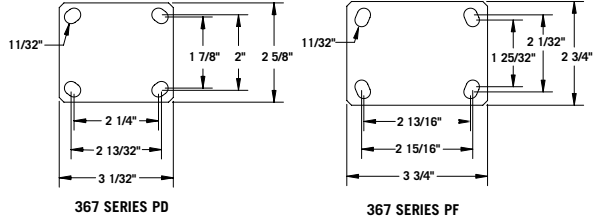

▼ DIMENSIONS

367/364 Series with Top Plate

	3"	4"	5"	6"
A: Wheel Diameter	3" (80mm)	4" (100mm)	5" (125mm)	6" (150mm)
B: Overall Height	4 1/2" (117mm)	5 1/4" (137mm)	6 1/2" (163mm)	7 1/2" (189mm)
C: Swivel Radius	3 1/4" (84mm)	3 1/2" (92mm)	3 1/4" (85mm)	4" (100mm)
C: Swivel Radius w/ brake	4" (100mm)	4 1/4" (106mm)	4 1/2" (110mm)	4 1/2" (110mm)

▼ SPECIFICATIONS

Wheel Diameter	Tread Width	Wheel Material	Wheel Bearing	Load Cap (lb)	Top Plate Caster	Top Plate EDP	Hollow Kingpin Caster	Hollow Kingpin EDP
3" (80mm)	1 1/4" (32mm)	TPR	Precision	220	364A35K080AZPF	07276		
3" (80mm)	1 1/4" (32mm)	TPR	Precision	220	367A35K080AZPF	07395	367A35K080AZLD	06304
3" (80mm)	1 1/4" (32mm)	TPR	Precision	220	367H35K080AZPF	08029	367H35K080AZLD	06245
3" (80mm)	1 1/4" (32mm)	TPR	Precision	220	367R35K080AZPF	06111		
4" (100mm)	1 1/4" (32mm)	TPR	Precision	220	364A35K100AZPF	07340		
4" (100mm)	1 1/4" (32mm)	TPR	Precision	220	367A35K100AZPF	07488	367A35K100AZLD	06307
4" (100mm)	1 1/4" (32mm)	TPR	Precision	220	367H35K100AZPF	07986	367H35K100AZLD	06306
4" (100mm)	1 1/4" (32mm)	TPR	Precision	220	367R35K100AZPF	06112		
5" (125mm)	1 1/4" (32mm)	TPR	Precision	220	364A35K125AZPF	07356		
5" (125mm)	1 1/4" (32mm)	TPR	Precision	220	367A35K125AZPF	07571	367A35K125AZLD	07571
5" (125mm)	1 1/4" (32mm)	TPR	Precision	220	367H35K125AZPF	08015	367H35K125AZLD	06309
5" (125mm)	1 1/4" (32mm)	TPR	Precision	220	367R35K125AZPF	06113		
6" (150mm)	1 1/4" (32mm)	TPR	Precision	220	364A35K150AZPF	07298		
6" (150mm)	1 1/4" (32mm)	TPR	Precision	220	367A35K150AZPF	07612	367A35K150AZLD	02109
6" (150mm)	1 1/4" (32mm)	TPR	Precision	220	367H35K150AZPF	08074	367H35K150AZLD	02113
6" (150mm)	1 1/4" (32mm)	TPR	Precision	220	367R35K150AZPF	06124		

▼ WHEEL OPTIONS

32C features black crown tread. To order change 35K to 32C.
35K features grey round tread.

▼ MOUNTING OPTIONS



▼ LOCK OPTIONS



PLASTIC ANTISTATIC (PA)

TOP PLATE MODELS

FREE SWIVEL • TOTAL LOCK • DIRECTION LOCK



- APPLICATIONS**
- Computer equipment
 - Electronic Equipment
 - Case Carts
 - Utility Carts
 - Medical Equipment
 - Institutional Equipment
 - Hospital Carts
 - Cart Washable applications

- FEATURES**
- Sealed Precision Bearing raceway, smooth and quiet
 - Total Lock Brake models lock both swivel and wheel
 - Directional lock models lock swivel only (helps with Steering)
 - Wheel feature precision bearings and full thread guards
 - Resistance to most chemicals
 - Recessed axle with Yellow plastic cap covers
 - Maintenance Free
 - European style, Yellow chromate top plate

Molded electronically conductive polyamide housing is water proof and features precision ball bearings. Wheel and fork standard color is dark gray.

SWIVEL TOP PLATE MODELS

Wheel Diameter (Inches)	Tread Width (Inches)	Wheel Description	Capacity (Lbs)	Load Height Inches (mm)	Swivel Radius Inches (mm)	Wheel Bearing	Model Number
4	1-1/4	Antistatic Poly	220	5-13/16" (148)	3-15/32" (88)	Precision Ball	PA-04APP-125-SW-TP01
5	1-1/4	Antistatic Poly	220	6-39/64" (168)	4-5/6" (110)	Precision Ball	PA-05APP-125-SW-TP01
6	1-1/4	Antistatic Poly	264	7-25/32" (198)	4-57/64" (124)	Precision Ball	PA-06APP-125-SW-TP01



SWIVEL TOP PLATE TOTAL LOCK MODELS

4	1-1/4	Antistatic Poly	220	5-13/16" (148)	4-21/64" (110)	Precision Ball	PA-04APP-125-TL-TP01
5	1-1/4	Antistatic Poly	220	6-39/64" (168)	4-23/32" (120)	Precision Ball	PA-05APP-125-TL-TP01
6	1-1/4	Antistatic Poly	264	7-25/32" (198)	5-9/32" (134)	Precision Ball	PA-06APP-125-TL-TP01



SWIVEL TOP PLATE DIRECTION LOCK MODELS

(LOCKS SWIVEL ONLY)

4	1-1/4	Antistatic Poly	220	5-13/16" (148)	4-21/64" (110)	Precision Ball	PA-04APP-125-DL-TP01
5	1-1/4	Antistatic Poly	220	6-39/64" (168)	4-23/32" (120)	Precision Ball	PA-05APP-125-DL-TP01
6	1-1/4	Antistatic Poly	264	7-25/32" (198)	5-9/32" (134)	Precision Ball	PA-06APP-125-DL-TP01



TOP PLATE FITTING TP01

Swivel Top Plate Pattern

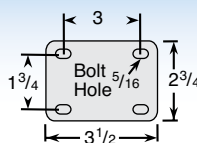

Our Directional Lock casters are designed to lock the swivel but not the wheel allowing you to steer your equipment. The directional lock feature is designed to break free under heavier load when the unit is traversing a corner only to lock back into position when the unit resumes a straight course.

Both the caster fork and wheel are electrically conductive. Caster conforms to CEN standards with resistance values < 10,000 ohms (measured at 500V DC, with minimum output of 50 V DC at 1,000 ohms resistance).

PLASTIC ANTISTATIC (PA) THREADED STEM MODELS

FREE SWIVEL • TOTAL LOCK • DIRECTION LOCK

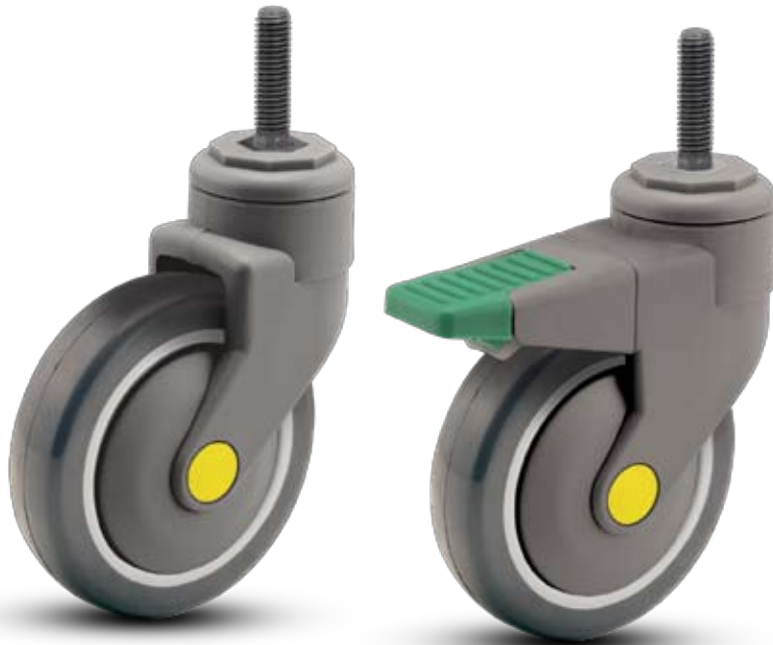

- APPLICATIONS**
- Computer equipment
 - Electronic Equipment
 - Case Carts
 - Utility Carts
 - Medical Equipment
 - Institutional Equipment
 - Hospital Carts
 - Cart Washable applications

- FEATURES**
- Sealed Precision Bearing raceway, smooth and quiet
 - Total Lock Brake models lock both swivel and wheel
 - Directional lock models lock swivel only (helps with Steering)
 - Wheel feature precision bearings and full thread guards
 - Resistance to most chemicals
 - Recessed axle with Yellow plastic cap covers
 - Maintenance Free



Hollow rivet models available. Consult factory.

Molded electronically conductive polyamide housing is water proof and features precision ball bearings. Wheel and fork standard color is dark gray.

THREADED STEM MODELS

Wheel Diameter (Inches)	Tread Width (Inches)	Wheel Description	Capacity (Lbs)	Load Height Inches (mm)	Swivel Radius Inches (mm)	Wheel Bearing	Model Number
4	1-1/4	Antistatic Poly	220	5-45/64" (145)	3-15/32" (88)	Precision Ball	PA-04APP-125-SW-___
5	1-1/4	Antistatic Poly	220	6-1/2" (165)	4-5/6" (110)	Precision Ball	PA-05APP-125-SW-___
6	1-1/4	Antistatic Poly	264	7-11/16" (195)	4-57/64" (124)	Precision Ball	PA-06APP-125-SW-___



THREADED STEM TOTAL LOCK MODELS (LOCKS WHEEL AND SWIVEL)

4	1-1/4	Antistatic Poly	220	5-45/64" (145)	4-21/64" (110)	Precision Ball	PA-04APP-125-TL-___
5	1-1/4	Antistatic Poly	220	6-1/2" (165)	4-23/32" (120)	Precision Ball	PA-05APP-125-TL-___
6	1-1/4	Antistatic Poly	264	7-11/16" (195)	5-9/32" (134)	Precision Ball	PA-06APP-125-TL-___

THREADED STEM DIRECTION LOCK MODELS (LOCKS SWIVEL ONLY)

4	1-1/4	Antistatic Poly	220	5-45/64" (145)	4-21/64" (110)	Precision Ball	PA-04APP-125-DL-___
5	1-1/4	Antistatic Poly	220	6-1/2" (165)	4-23/32" (120)	Precision Ball	PA-05APP-125-DL-___
6	1-1/4	Antistatic Poly	264	7-11/16" (195)	5-9/32" (134)	Precision Ball	PA-06APP-125-DL-___

Our Directional Lock casters are designed to lock the swivel but not the wheel allowing you to steer your equipment. The directional lock feature is designed to break free under heavier load when the unit is traversing a corner only to lock back into position when the unit resumes a straight course.

Specify Threaded Stem (TS) code, see fittings below for dimensions:

THREADED STEM FITTINGS

Easy to install stem. See fittings page for more options.

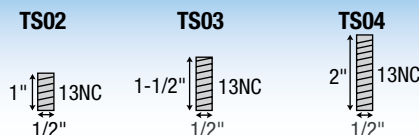

Both the caster fork and wheel are electrically conductive. Caster conforms to CEN standards with resistance values < 10,000 ohms (measured at 500V DC, with minimum output of 50 V DC at 1,000 ohms resistance).

MEDCASTER BED CASTERS

MED-BED (MB)



New central lock
brake design

**HOSPITAL BED
STAINLESS (HS)**



304 Stainless Steel
Finish

**HOSPITAL BED
CHROME (HC)**



Attractive Chrome
Finish

**MED-BED
ULTRA (MU)**



Hooded Twin Wheel
Easy Turning in Tight
Spots

**TWIN-TECH
ULTRA (TU)**



Unhooded Twin Wheel
Easy Turning in Tight
Spots

Typical Configurations for our Hospital bed Casters

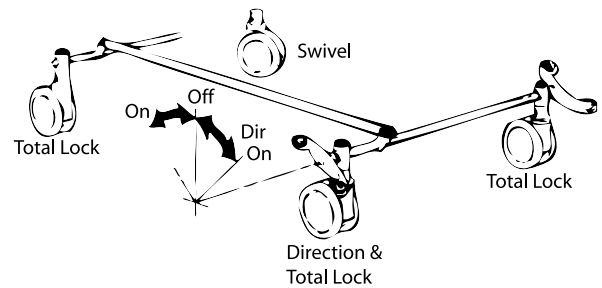
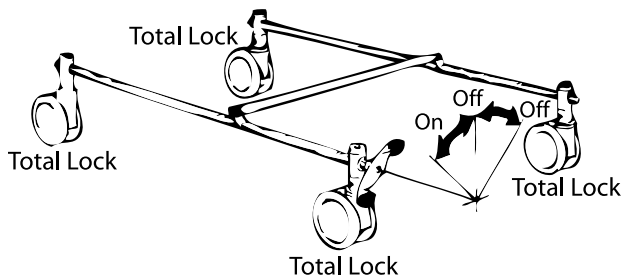

See page 106 for levers and adaptors

MED-BED (MB)

FREE SWIVEL • TOTAL LOCK •
TOTAL/DIRECTION LOCK COMBO



New 8" Wheel Diameter Model

APPLICATIONS

- Hospital Beds
- Stretchers
- Gurneys
- Medical Chains

Anti-Microbial wheels available. Consult factory.

FEATURES

- New 8" diameter models feature sealed precision ball raceway
- Wheels have full plastic thread guards
- Full double ball bearing raceways on 4" & 5" models
- Very Positive swivel lock—operates independently of the wheel brake, reducing wear and tendency to ratchet
- Precision ball bearings in wheels for easier rollability
- Wheels are crowned for easy rolling and turning
- Swivel rigs have a bright chrome finish
- Cam-hole orientation to customer specification - can be in direction of travel, or 90 degrees to direction of travel.
- Factory-set mechanism, maintenance-free for the life of the caster
- Stem with 4 x M8 fixing holes to suit all bed layouts and reduce extra inventory needs.

Our new central locking brake design provides a more positive wheel lock with more surface contact on the wheel. Caster meets ISO Standard 22882: 2004 Casters & Wheels - Requirements for Casters for Hospital Beds.

CENTRAL LOCKING TOTAL LOCK

Wheel Diameter Inches (mm)	Tread Width (Inches)	Wheel Description	Capacity (Lbs)	Load Height Inches (mm)	Swivel Radius Inches (mm)	Wheel Bearing	Model Number
4" (100)	1-1/4	Thermoplastic Rubber	198	5-7/16" (138)	3-15/32" (88)	Precision Ball	MB-04TPP-125-TL-___
5" (125)	1-1/4	Thermoplastic Rubber	220	6-27/64"(163)	3-37/64" (91)	Precision Ball	MB-05TPP-125-TL-___
8" (200)	1-1/4	Polyurethane TPU	330	9-7/16" (240)	6-3/8" (162)	Precision Ball	MB-08PYP-125-TL-___

CENTRAL LOCKING RUBBER DIRECTIONAL AND TOTAL LOCK COMBO

4" (100)	1-1/4	Thermoplastic Rubber	198	5-7/16" (138)	3-15/32" (88)	Precision Ball	MB-04TPP-125-DT-___
5" (125)	1-1/4	Thermoplastic Rubber	220	6-27/64"(163)	3-37/64" (91)	Precision Ball	MB-05TPP-125-DT-___
8" (200)	1-1/4	Polyurethane TPU	330	9-7/16" (240)	6-3/8" (162)	Precision Ball	MB-08PYP-125-DT-___

FREE SWIVEL MODELS

4" (100)	1-1/4	Thermoplastic Rubber	198	5-7/16" (138)	3-15/32" (88)	Precision Ball	MB-04TPP-125-SW-___
5" (125)	1-1/4	Thermoplastic Rubber	220	6-27/64"(163)	3-37/64" (91)	Precision Ball	MB-05TPP-125-SW-___
8" (200)	1-1/4	Polyurethane TPU	330	9-7/16" (240)	6-3/8" (162)	Precision Ball	MB-08PYP-125-SW-___

Locking Models

M8 threaded holes for fitting either in the direction of travel or 90 degrees to direction of travel

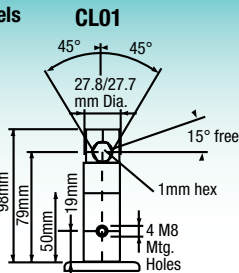

CL02

M6 threaded holes for fitting either in the direction of travel.

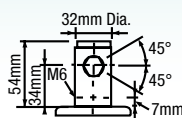

Free Swivel Models

RS03

27.8mm x 45mm for tubular frame with 28mm ID

RS05

32mm x 54mm For tubular frame with 32mm ID

HOSPITAL BED CHROME (HC)

FREE SWIVEL • TOTAL LOCK • TOTAL/DIRECTION LOCK COMBO



APPLICATIONS

- Hospital Beds
- Stretchers

FEATURES

- Bright Chrome Finish
- Wheels are non-marking
- Swivel, total lock and direction lock + total lock models available
- Available with santoprene rubber, polyurethane and anti-static wheels
- Resistant to many cleaning and disinfectant solutions
- Swivel raceway has sealed precision bearing for smooth easy swiveling
- Wheels are provided with sealed precision bearings for easy rolling
- Wheels feature full thread Guards
- M8 threaded holes for fitting either in the direction of travel or 90 degrees to direction of travel

HC hospital bed chrome casters feature attractive bright chrome finish. Wheels and swivel feature precision bearing for smooth operation.

CENTRAL LOCKING FREE SWIVEL MODELS

Wheel Diameter Inches (mm)	Tread Width (Inches)	Wheel Description	Capacity (Lbs)	Load Height (Inches)	Swivel Radius (Inches)	Wheel Bearing	Model Number
4" (100)	1-1/4	Rubber on Plastic	220	5-29/32" (150)	3-45/64" (94)	Precision Ball	HC-04RPP-125-SW-___
4" (100)	1-1/4	Polyurethane	220	5-29/32" (150)	3-45/64" (94)	Precision Ball	HC-04PYP-125-SW-___
4" (100)	1-1/4	Polyurethane Anti-static	220	5-29/32" (150)	3-45/64" (94)	Precision Ball	HC-04APP-125-SW-___
5" (125)	1-1/4	Rubber on Plastic	220	6-57/64" (175)	4-15/64" (107)	Precision Ball	HC-05RPP-125-SW-___
5" (125)	1-1/4	Polyurethane	220	6-57/64" (175)	4-15/64" (107)	Precision Ball	HC-05PYP-125-SW-___
5" (125)	1-1/4	Polyurethane Anti-static	220	6-57/64" (175)	4-15/64" (107)	Precision Ball	HC-05APP-125-SW-___
6" (150)	1-1/4	Rubber on Plastic	240	7-7/8" (200)	4-31/32" (126)	Precision Ball	HC-06RPP-125-SW-___
6" (150)	1-1/4	Polyurethane	240	7-7/8" (200)	4-31/32" (126)	Precision Ball	HC-06PYP-125-SW-___
6" (150)	1-1/4	Polyurethane Anti-static	240	7-7/8" (200)	4-31/32" (126)	Precision Ball	HC-06APP-125-SW-___
8" (200)	1-1/4	Rubber on Plastic	264	9-27/32" (250)	6-1/16" (154)	Precision Ball	HC-08RPP-125-SW-___
8" (200)	1-1/4	Polyurethane	264	9-27/32" (250)	6-1/16" (154)	Precision Ball	HC-08PYP-125-SW-___
8" (200)	1-1/4	Polyurethane Anti-static	264	9-27/32" (250)	6-1/16" (154)	Precision Ball	HC-08APP-125-SW-___

Free Swivel Models (Total/Direction next page)

RS03



27.8mm x 45mm for tubular frame with 28mm ID

RS05



32mm x 54mm For tubular frame with 32mm ID

See total lock and direction lock models on next page

HOSPITAL BED CHROME (HC)

FREE SWIVEL • TOTAL LOCK •
TOTAL/DIRECTION LOCK COMBO

CENTRAL LOCKING TOTAL LOCK MODELS

Wheel Diameter Inches (mm)	Tread Width (Inches)	Wheel Description	Capacity (Lbs)	Load Height (Inches)	Swivel Radius (Inches)	Wheel Bearing	Model Number
4" (100)	1-1/4	Rubber on Plastic	220	5-29/32" (150)	3-45/64" (94)	Precision Ball	HC-04RPP-125-TL-_____
4" (100)	1-1/4	Polyurethane	220	5-29/32" (150)	3-45/64" (94)	Precision Ball	HC-04PYP-125-TL-_____
4" (100)	1-1/4	Polyurethane Anti-static	220	5-29/32" (150)	3-45/64" (94)	Precision Ball	HC-04APP-125-TL-_____
5" (125)	1-1/4	Rubber on Plastic	220	6-57/64" (175)	4-15/64" (107)	Precision Ball	HC-05RPP-125-TL-_____
5" (125)	1-1/4	Polyurethane	220	6-57/64" (175)	4-15/64" (107)	Precision Ball	HC-05PYP-125-TL-_____
5" (125)	1-1/4	Polyurethane Anti-static	220	6-57/64" (175)	4-15/64" (107)	Precision Ball	HC-05APP-125-TL-_____
6" (150)	1-1/4	Rubber on Plastic	240	7-7/8" (200)	4-31/32" (126)	Precision Ball	HC-06RPP-125-TL-_____
6" (150)	1-1/4	Polyurethane	240	7-7/8" (200)	4-31/32" (126)	Precision Ball	HC-06PYP-125-TL-_____
6" (150)	1-1/4	Polyurethane Anti-static	240	7-7/8" (200)	4-31/32" (126)	Precision Ball	HC-06APP-125-TL-_____
8" (200)	1-1/4	Rubber on Plastic	264	9-27/32" (250)	6-1/16" (154)	Precision Ball	HC-08RPP-125-TL-_____
8" (200)	1-1/4	Polyurethane	264	9-27/32" (250)	6-1/16" (154)	Precision Ball	HC-08PYP-125-TL-_____
8" (200)	1-1/4	Polyurethane Anti-static	264	9-27/32" (250)	6-1/16" (154)	Precision Ball	HC-08APP-125-TL-_____

CENTRAL LOCKING DIRECTIONAL AND TOTAL LOCK COMBO

Wheel Diameter Inches (mm)	Tread Width (Inches)	Wheel Description	Capacity (Lbs)	Load Height (Inches)	Swivel Radius (Inches)	Wheel Bearing	Model Number
4" (100)	1-1/4	Rubber on Plastic	220	5-29/32" (150)	3-45/64" (94)	Precision Ball	HC-04RPP-125-DT-_____
4" (100)	1-1/4	Polyurethane	220	5-29/32" (150)	3-45/64" (94)	Precision Ball	HC-04PYP-125-DT-_____
4" (100)	1-1/4	Polyurethane Anti-static	220	5-29/32" (150)	3-45/64" (94)	Precision Ball	HC-04APP-125-DT-_____
5" (125)	1-1/4	Rubber on Plastic	220	6-57/64" (175)	4-15/64" (107)	Precision Ball	HC-05RPP-125-DT-_____
5" (125)	1-1/4	Polyurethane	220	6-57/64" (175)	4-15/64" (107)	Precision Ball	HC-05PYP-125-DT-_____
5" (125)	1-1/4	Polyurethane Anti-static	220	6-57/64" (175)	4-15/64" (107)	Precision Ball	HC-05APP-125-DT-_____
6" (150)	1-1/4	Rubber on Plastic	240	7-7/8" (200)	4-31/32" (126)	Precision Ball	HC-06RPP-125-DT-_____
6" (150)	1-1/4	Polyurethane	240	7-7/8" (200)	4-31/32" (126)	Precision Ball	HC-06PYP-125-DT-_____
6" (150)	1-1/4	Polyurethane Anti-static	240	7-7/8" (200)	4-31/32" (126)	Precision Ball	HC-06APP-125-DT-_____
8" (200)	1-1/4	Rubber on Plastic	264	9-27/32" (250)	6-1/16" (154)	Precision Ball	HC-08RPP-125-DT-_____
8" (200)	1-1/4	Polyurethane	264	9-27/32" (250)	6-1/16" (154)	Precision Ball	HC-08PYP-125-DT-_____
8" (200)	1-1/4	Polyurethane Anti-static	264	9-27/32" (250)	6-1/16" (154)	Precision Ball	HC-08APP-125-DT-_____

Locking Models

M8 threaded holes for fitting either in the direction of travel or 90 degrees to direction of travel

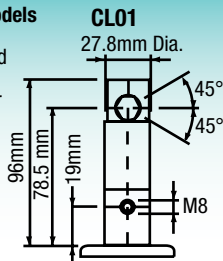

CL02

M6 threaded holes for fitting either in the direction of travel.

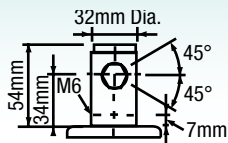

HOSPITAL BED STAINLESS (HS)

FREE SWIVEL • TOTAL LOCK • TOTAL/DIRECTION LOCK COMBO



APPLICATIONS

- Hospital Beds
- Stretchers

FEATURES

- Stainless Steel 304 Finish
- Wheels are Non-marking
- Swivel, total lock and direction lock + total lock models available
- Resistant to many cleaning and disinfectant solutions
- Wheels are provided with sealed precision bearings for easy rolling
- Wheels feature full thread guards
- Swivel raceway has sealed precision bearing for smooth easy swiveling
- Available with santoprene rubber, polyurethane and anti-static wheels
- Central Locking Stem and brake mechanism have Zinc Finish
- M8 threaded holes for fitting either in the direction of travel or 90 degrees to direction of travel

HS hospital bed chrome casters feature attractive 304 stainless steel. Wheels and swivel feature precision bearing for smooth operation.

CENTRAL LOCKING FREE SWIVEL MODELS

Wheel Diameter Inches (mm)	Tread Width (Inches)	Wheel Description	Capacity (Lbs)	Load Height (Inches)	Swivel Radius (Inches)	Wheel Bearing	Model Number
4" (100)	1-1/4	Rubber on Plastic	220	5-29/32" (150)	3-45/64" (94)	Precision Ball	HS-04RPP-125-SW-___
4" (100)	1-1/4	Polyurethane	220	5-29/32" (150)	3-45/64" (94)	Precision Ball	HS-04PYP-125-SW-___
4" (100)	1-1/4	Polyurethane Anti-static	220	5-29/32" (150)	3-45/64" (94)	Precision Ball	HS-04APP-125-SW-___
5" (125)	1-1/4	Rubber on Plastic	220	6-57/64" (175)	4-15/64" (107)	Precision Ball	HS-05RPP-125-SW-___
5" (125)	1-1/4	Polyurethane	220	6-57/64" (175)	4-15/64" (107)	Precision Ball	HS-05PYP-125-SW-___
5" (125)	1-1/4	Polyurethane Anti-static	220	6-57/64" (175)	4-15/64" (107)	Precision Ball	HS-05APP-125-SW-___
6" (150)	1-1/4	Rubber on Plastic	240	7-7/8" (200)	4-31/32" (126)	Precision Ball	HS-06RPP-125-SW-___
6" (150)	1-1/4	Polyurethane	240	7-7/8" (200)	4-31/32" (126)	Precision Ball	HS-06PYP-125-SW-___
6" (150)	1-1/4	Polyurethane Anti-static	240	7-7/8" (200)	4-31/32" (126)	Precision Ball	HS-06APP-125-SW-___
8" (200)	1-1/4	Rubber on Plastic	264	9-27/32" (250)	6-1/16" (154)	Precision Ball	HS-08RPP-125-SW-___
8" (200)	1-1/4	Polyurethane	264	9-27/32" (250)	6-1/16" (154)	Precision Ball	HS-08PYP-125-SW-___
8" (200)	1-1/4	Polyurethane Anti-static	264	9-27/32" (250)	6-1/16" (154)	Precision Ball	HS-08APP-125-SW-___

Free Swivel Models (Total/Direction next page)

RS03

27.8mm x 45mm
for tubular frame
with 28mm ID

RS05

32mm x 54mm
For tubular frame
with 32mm ID

See total lock and direction lock models on next page

HOSPITAL BED STAINLESS (HS)

FREE SWIVEL • TOTAL LOCK •
TOTAL/DIRECTION LOCK COMBO

CENTRAL LOCKING TOTAL LOCK MODELS

Wheel Diameter Inches (mm)	Tread Width (Inches)	Wheel Description	Capacity (Lbs)	Load Height (Inches)	Swivel Radius (Inches)	Wheel Bearing	Model Number
4" (100)	1-1/4	Rubber on Plastic	220	5-29/32" (150)	3-45/64" (94)	Precision Ball	HS-04RPP-125-TL-_____
4" (100)	1-1/4	Polyurethane	220	5-29/32" (150)	3-45/64" (94)	Precision Ball	HS-04PYP-125-TL-_____
4" (100)	1-1/4	Polyurethane Anti-static	220	5-29/32" (150)	3-45/64" (94)	Precision Ball	HS-04APP-125-TL-_____
5" (125)	1-1/4	Rubber on Plastic	220	6-57/64" (175)	4-15/64" (107)	Precision Ball	HS-05RPP-125-TL-_____
5" (125)	1-1/4	Polyurethane	220	6-57/64" (175)	4-15/64" (107)	Precision Ball	HS-05PYP-125-TL-_____
5" (125)	1-1/4	Polyurethane Anti-static	220	6-57/64" (175)	4-15/64" (107)	Precision Ball	HS-05APP-125-TL-_____
6" (150)	1-1/4	Rubber on Plastic	240	7-7/8" (200)	4-31/32" (126)	Precision Ball	HS-06RPP-125-TL-_____
6" (150)	1-1/4	Polyurethane	240	7-7/8" (200)	4-31/32" (126)	Precision Ball	HS-06PYP-125-TL-_____
6" (150)	1-1/4	Polyurethane Anti-static	240	7-7/8" (200)	4-31/32" (126)	Precision Ball	HS-06APP-125-TL-_____
8" (200)	1-1/4	Rubber on Plastic	264	9-27/32" (250)	6-1/16" (154)	Precision Ball	HS-08RPP-125-TL-_____
8" (200)	1-1/4	Polyurethane	264	9-27/32" (250)	6-1/16" (154)	Precision Ball	HS-08PYP-125-TL-_____
8" (200)	1-1/4	Polyurethane Anti-static	264	9-27/32" (250)	6-1/16" (154)	Precision Ball	HS-08APP-125-TL-_____

CENTRAL LOCKING DIRECTIONAL AND TOTAL LOCK COMBO

Wheel Diameter Inches (mm)	Tread Width (Inches)	Wheel Description	Capacity (Lbs)	Load Height (Inches)	Swivel Radius (Inches)	Wheel Bearing	Model Number
4" (100)	1-1/4	Rubber on Plastic	220	5-29/32" (150)	3-45/64" (94)	Precision Ball	HS-04RPP-125-DT-_____
4" (100)	1-1/4	Polyurethane	220	5-29/32" (150)	3-45/64" (94)	Precision Ball	HS-04PYP-125-DT-_____
4" (100)	1-1/4	Polyurethane Anti-static	220	5-29/32" (150)	3-45/64" (94)	Precision Ball	HS-04APP-125-DT-_____
5" (125)	1-1/4	Rubber on Plastic	220	6-57/64" (175)	4-15/64" (107)	Precision Ball	HS-05RPP-125-DT-_____
5" (125)	1-1/4	Polyurethane	220	6-57/64" (175)	4-15/64" (107)	Precision Ball	HS-05PYP-125-DT-_____
5" (125)	1-1/4	Polyurethane Anti-static	220	6-57/64" (175)	4-15/64" (107)	Precision Ball	HS-05APP-125-DT-_____
6" (150)	1-1/4	Rubber on Plastic	240	7-7/8" (200)	4-31/32" (126)	Precision Ball	HS-06RPP-125-DT-_____
6" (150)	1-1/4	Polyurethane	240	7-7/8" (200)	4-31/32" (126)	Precision Ball	HS-06PYP-125-DT-_____
6" (150)	1-1/4	Polyurethane Anti-static	240	7-7/8" (200)	4-31/32" (126)	Precision Ball	HS-06APP-125-DT-_____
8" (200)	1-1/4	Rubber on Plastic	264	9-27/32" (250)	6-1/16" (154)	Precision Ball	HS-08RPP-125-DT-_____
8" (200)	1-1/4	Polyurethane	264	9-27/32" (250)	6-1/16" (154)	Precision Ball	HS-08PYP-125-DT-_____
8" (200)	1-1/4	Polyurethane Anti-static	264	9-27/32" (250)	6-1/16" (154)	Precision Ball	HS-08APP-125-DT-_____

Locking Models

M8 threaded holes for fitting either in the direction of travel or 90 degrees to direction of travel

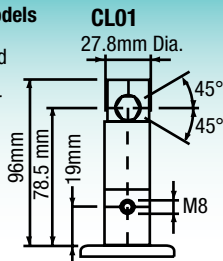

CL02

M6 threaded holes for fitting either in the direction of travel.

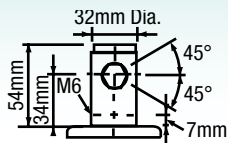

MED-ULTRA (MU)

FREE SWIVEL • TOTAL LOCK • TOTAL/DIRECTION LOCK COMBO



APPLICATIONS

- Hospital Beds
- Stretchers
- Ultrasonic Equipment

FEATURES

- Precision bearings in wheels
- Caster meets ISO Standard 22882: 2004 Caster & Wheels - Requirements for Casters for Hospital Beds.
- Central-locking brake design has very Positive swivel lock - operates independently of the wheel brake, reducing wear and tendency to ratchet
- Wheel brake can be applied dynamically without damage to mechanism.
- Factory-set mechanism, maintenance-free for the life of the caster
- Stem with 4 x M8 fixing holes to suit all bed layouts and reduce stock holding.

Dual wheel design improves turning. Our new central locking brake design provides a more positive wheel lock with more surface contact on the wheel. Caster meets ISO Standard 22882: 2004 Casters & Wheels - Requirements for Casters for Hospital Beds.

Wheel Diameter Inches (mm)	Tread Width Inches (mm)	Wheel Description	Capacity (Lbs)	Load Height Inches (mm)	Swivel Lead Inches (mm)	Wheel Bearing	Model Number
CENTRAL LOCKING TOTAL LOCK MODELS							
5" (125)	2-1/2"(65)	Polyurethane Gray	352	6-1/64" (153)	1-37/64" (40)	Precision Ball	MU-05PYP-283-TL-____
5" (125)	2-1/2"(65)	Polyurethane Anti-Static	352	6-1/64" (153)	1-37/64" (40)	Precision Ball	MU-05APP-283-TL-____
6" (150)	3-5/32"(80)	Polyurethane Gray	484	7-1/16" (179)	1-25/32" (45)	Precision Ball	MU-06PYP-283-TL-____
6" (150)	3-5/32"(80)	Polyurethane Anti-Static	484	7-1/16" (179)	1-25/32" (45)	Precision Ball	MU-06APP-283-TL-____

CENTRAL LOCKING DIRECTIONAL AND TOTAL LOCK COMBO

5" (127)	2-1/2"(65)	Polyurethane Gray	352	6-1/64" (153)	1-37/64" (40)	Precision Ball	MU-05PYP-283-DT-____
5" (127)	2-1/2"(65)	Polyurethane Anti-Static	352	6-1/64" (153)	1-37/64" (40)	Precision Ball	MU-05APP-283-DT-____
6" (150)	3-5/32"(80)	Polyurethane Gray	484	7-1/16" (179)	1-25/32" (45)	Precision Ball	MU-06PYP-283-DT-____
6" (150)	3-5/32"(80)	Polyurethane Anti-Static	484	7-1/16" (179)	1-25/32" (45)	Precision Ball	MU-06APP-283-DT-____

FREE SWIVEL MODELS

5" (127)	2-1/2"(65)	Polyurethane Gray	352	6-1/64" (153)	1-37/64" (40)	Precision Ball	MU-05PYP-283-SW-____
5" (127)	2-1/2"(65)	Polyurethane Anti-Static	352	6-1/64" (153)	1-37/64" (40)	Precision Ball	MU-05APP-283-SW-____
6" (150)	3-5/32"(80)	Polyurethane Gray	484	7-1/16" (179)	1-25/32" (45)	Precision Ball	MU-06PYP-283-SW-____
6" (150)	3-5/32"(80)	Polyurethane Anti-Static	484	7-1/16" (179)	1-25/32" (45)	Precision Ball	MU-06APP-283-SW-____

Locking Models

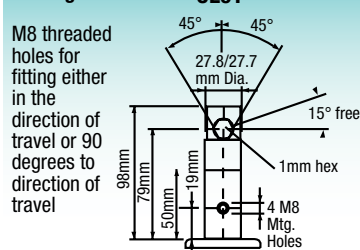

CL02

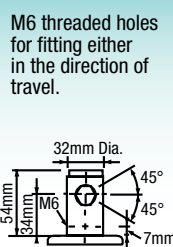

Free Swivel Models

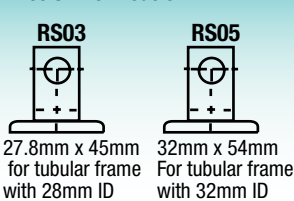

TWIN-TECH ULTRA (TU)

FREE SWIVEL • TOTAL LOCK •
TOTAL/DIRECTION LOCK COMBO

NEW



APPLICATIONS

- Hospital Beds
- Stretchers
- Ultrasonic Equipment

FEATURES

- Precision bearings in wheels
- Caster meets ISO Standard 22882: 2004 Caster & Wheels - Requirements for Casters for Hospital Beds.
- Central-locking brake design has very Positive swivel lock - operates independently of the wheel brake, reducing wear and tendency to ratchet
- Wheel brake can be applied dynamically without damage to mechanism.
- Factory-set mechanism, maintenance-free for the life of the caster
- Stem with 4 x M8 fixing holes to suit all bed layouts and reduce stock holding.

Dual wheel design improves turning. Our new central locking brake design provides a more positive wheel lock with more surface contact on the wheel. Caster meets ISO Standard 22882: 2004 Casters & Wheels - Requirements for Casters for Hospital Beds.

CENTRAL LOCKING TOTAL LOCK MODELS

Wheel Diameter (Inches)	Tread Width (Inches/mm)	Wheel Description	Capacity (Lbs)	Load Height (Inches/mm)	Swivel Radius (Inches/mm)	Wheel Bearing	Model Number
5"/127	2-1/2"/65	Polyurethane Gray	297	5-7/16"/138	4-9/64"/105	Precision Ball	TU-05PYP-283-TL-_____
6"/152	2-1/2"/65	Polyurethane Gray	330	6-15/32"/164	4-31/32"/126	Precision Ball	TU-06PYP-283-TL-_____

CENTRAL LOCKING DIRECTIONAL AND TOTAL LOCK COMBO

Wheel Diameter (Inches/mm)	Tread Width (Inches/mm)	Wheel Description	Capacity (Lbs)	Load Height (Inches/mm)	Swivel Radius (Inches/mm)	Wheel Bearing	Model Number
5"/127	2-1/2"/65	Polyurethane Gray	297	5-7/16"/138	4-9/64"/105	Precision Ball	TU-05PYP-283-DT-_____
6"/152	2-1/2"/65	Polyurethane Gray	330	6-15/32"/164	4-31/32"/126	Precision Ball	TU-06PYP-283-DT-_____

FREE SWIVEL MODELS

Wheel Diameter (Inches/mm)	Tread Width (Inches/mm)	Wheel Description	Capacity (Lbs)	Load Height (Inches/mm)	Swivel Radius (Inches/mm)	Wheel Bearing	Model Number
5"/127	2-1/2"/65	Polyurethane Gray	297	5-7/16"/138	4-9/16"/105	Precision Ball	TU-05PYP-283-SW-_____
6"/152	2-1/2"/65	Polyurethane Gray	330	6-15/32"/164	4-31/32"/126	Precision Ball	TU-06PYP-283-SW-_____

Locking Models

M8 threaded holes for fitting either in the direction of travel or 90 degrees to direction of travel

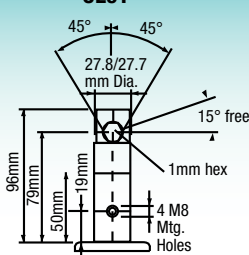

CL02

M6 threaded holes for fitting either in the direction of travel.

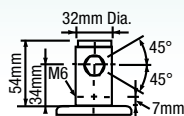

Free Swivel Models



27.8mm x 45mm for tubular frame with 28mm ID



32mm x 54mm For tubular frame with 32mm ID

BED ACCESSORIES

MedCaster Bed System Caster Accessories



T3: double lever, round profile



A1: double lever in chrome, flat profile



C1: steel adapter



B5: adapter



B3: change lever



B1: chrome change lever

Rhombus Bed System Caster Accessories

Rhombus Caster pedals combine ergonomics and durability in an easy-to-operate design that functions flawlessly with Rhombus Caster braking systems.

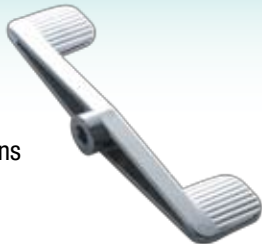

Foot Pedal Double

Description	11mm Hex Hole EDP	11/16" Hex Hole EDP
left	DHL	9 511 074
right	DHR	9 511 073



Foot Pedal Double (Plastic)

Description	11mm Hex Hole EDP
left	KDHL
right	KDHR



Transmission Lever Long

11mm Hex Hole EDP	11/16" Hex Hole EDP
MNL	9 511 019



Foot Pedal Single

Description	11mm Hex Hole EDP	11/16" Hex Hole EDP
left	EHL	1 850 298
right	EHR	1 850 297



Foot Pedal Single (Plastic)

Description	11mm Hex Hole EDP
left	KEHL
right	KEHR



Transmission Lever Short

11mm Hex Hole EDP	11/16" Hex Hole EDP
MNK	1 850 5137

RHOMBUS



CASTERS

NEW

MedCaster is now the USA supplier of Rhombus Casters and Wheels! Rhombus Nimbus 399 Series casters combine aesthetics, quality, and functionality into a brilliant design. Not only is the Nimbus 399 quite possibly the most visually appealing healthcare caster ever created, it also meets the stringent requirements for medical equipment hygiene. Suitable for use in autoclaves, the Nimbus 399 Series features a die-cast aluminum, load-bearing housing and a highly polished, gently curved plastic cover in white or grey. Additional features include a precision ball bearing swivel head and an integrated selection mechanism with a central locking or directional locking brake. The innovative and elegant Nimbus 399 Series is designed to provide reliable performance and long service life under the rigorous demands of healthcare applications, including care beds, hospital beds, intensive care beds, medical equipment, operating tables, and operating beds. The Nimbus 399 Series is also available in an electrically conductive version. Other popular Rhombus casters supplied by MedCaster include Bariatric 389, 390 and 391, 367 and 364 casters.

NIMBUS 399



Page 108-109

BARIATRIC 389



Page 110-111

390/391 PRECISION & 390/391 PRECISION+



Page 112-113

367 & 364



Page 114-115

400 SERIES



Consult MedCaster for details.

RHOMBUS

NIMBUS 399

- APPLICATIONS**
- Care beds
 - Hospital beds
 - Intensive care beds
 - Medical appliances
 - OR beds
 - OR tables
 - Stretches
 - Gurneys

- FEATURES**
- Die-cast aluminum load-bearing housing
 - Highly polished plastic cover in white RAL 9016 or metallic
 - Unique design and patented technology
 - Precision ball bearings in the raceway
 - Autoclave safe
 - Smooth selection function
 - Integrated selection mechanism with total locking brake "Q" and position locking brake "R"
 - Load capacity 330 lb



399Q (Swivel with Total Lock)
399R (Swivel with Total and Position Lock)



Available in Grey*

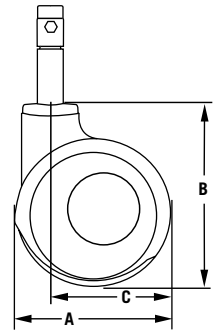

▼ DIMENSIONS

399 Series	
A: Wheel Diameter	6" (150mm)
B: Overall Height	7 1/2" (188mm)
C: Swivel Radius	4 1/2" (117mm)

▼ PEDAL SETTINGS

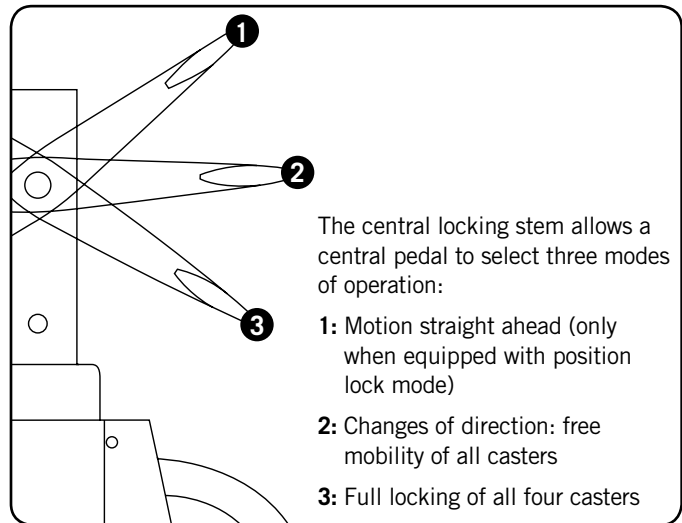

▼ AWARDS



reddot design award
winner 2006



RHOMBUS



NIMBUS 399

▼ SPECIFICATIONS

Wheel Diameter	Tread Width	Wheel Material	Wheel Bearing	Load Cap (lb)	Stem (78.5mm)	EDP	Stem (34mm)	EDP
6" (150mm)	1 1/4" (32mm)	Polyurethane	Precision	330	399Q38K150VK2351	02027	399Q38K150VK985	02144
6" (150mm)	1 1/4" (32mm)	Polyurethane	Precision	330	399R38K150VK2351	02028	399R38K150VK985	02145

The measurements in millimeters are exact.

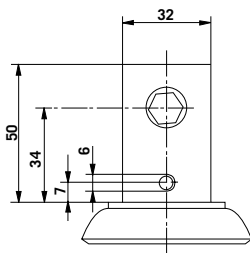

- Stem diameter 32mm
- Two locking hole options available
- Locking hole in line or across direction of travel
- Four fixing holes

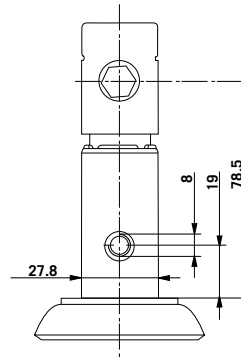

- Stem diameter 27.8mm
- Two locking hole options available
- Locking hole in line or across direction of travel
- Four fixing holes
- Snap-on adapter sleeves available for different tube dimensions

▼ MOUNTING OPTIONS



RHOMBUS



BARIATRIC 389

APPLICATIONS

- Mobile X-ray equipment
- Ultrasounds
- Large electrical medical equipment
- Bariatric hospital beds, chairs, tables

FEATURES

- Double ball raceway
- Integrated selection mechanism with total locking brake "Q" and direction locking brake "R"
- Selection mechanism continually greased
- Compatible with other caster systems
- Powder-coated horn and wheel guard
- Zinc models available, consult factory



389Q
(Swivel with Total Lock)
389R
(Swivel with Total and Position Lock)



385A

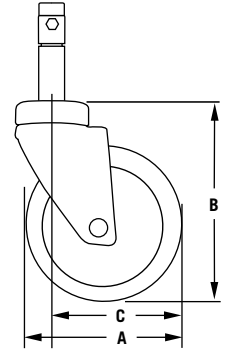

▼ DIMENSIONS

389/385 Series

A: Wheel Diameter	6 1/4" (160mm)	8" (200mm)
B: Overall Height	8" (200mm)	9 1/2" (245mm)
C: Swivel Radius	5" (125mm)	6 1/4" (158mm)

▼ PEDAL SETTINGS

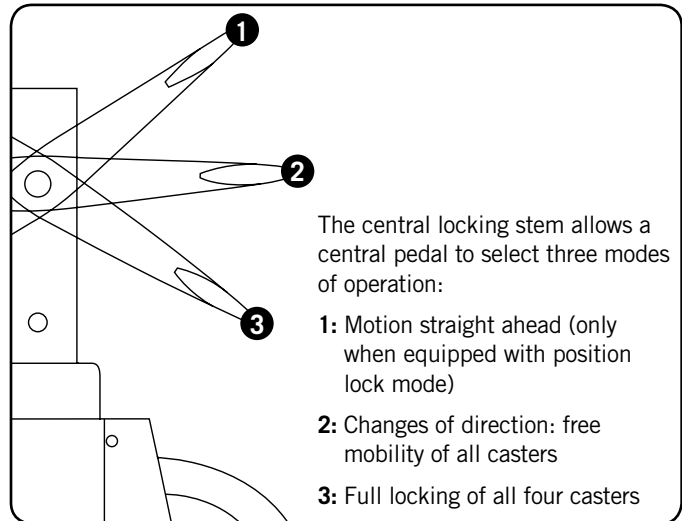

RHOMBUS



BARIATRIC 389

▼ SPECIFICATIONS

Wheel Diameter	Tread Width	Wheel Material	Wheel Bearing	Load Cap (lb)	Central Locking Caster	EDP
6 1/4" (160mm)	1 3/4" (45mm)	Polyurethane	Precision	550	385A43K160RP016	02003
6 1/4" (160mm)	1 3/4" (45mm)	Polyurethane	Precision	550	389R43K160RP016	02005
6 1/4" (160mm)	1 3/4" (45mm)	Polyurethane	Precision	550	389Q43K160RP016	02007
8" (200mm)	1 3/4" (45mm)	Polyurethane	Precision	600	385A43K200RP016	02004
8" (200mm)	1 3/4" (45mm)	Polyurethane	Precision	600	389R43K200RP016	02006
8" (200mm)	1 3/4" (45mm)	Polyurethane	Precision	600	389Q43K200RP016	02008

The measurements in inches are exact.

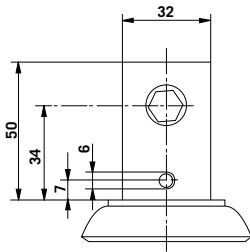

- Stem diameter 32mm
- Two locking hole options available
- Locking hole in line or across direction of travel
- Four fixing holes

▼ MOUNTING OPTIONS



▼ WHEEL OPTIONS

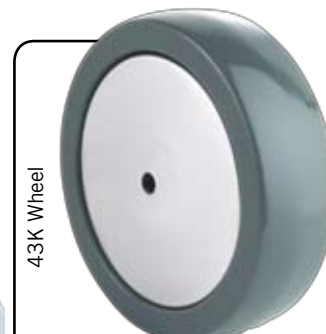

RHOMBUS



390 & 390+



390Q
(Swivel with Total Lock)
390R
(Swivel with Total and
Position Lock)



APPLICATIONS

- Care beds
- Hospital beds
- Intensive care beds
- OR beds and tables
- Stretchers
- Gurneys

FEATURES

- Stamped and drawn horn assembly
- Zinc-plated
- Double ball raceway that's sealed
- Up-to-date design with high-quality plastic cover (390+ only)
- Plastic seal protects from dust and water
- Integrated selection mechanism with total lock brake "Q" and position locking brake "R"
- Selection mechanism continually greased
- Brake adjustment feature is standard
- 390+ casters have protective covers available in white or dark grey*
- **Also available with precision bearing raceway (Change 390 to 391 in model number).**

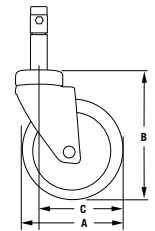

▼ DIMENSIONS

390 Series

A: Wheel Diameter	3" (80mm)	4" (100mm)	5" (125mm)
B: Overall Height	4 1/2" (113mm)	5 1/4" (133mm)	6 1/4" (158mm)
C: Swivel Radius	3 1/4" (84mm)	3 1/2" (92mm)	4 1/4" (107mm)
A: Wheel Diameter	6" (150mm)	8" (200mm)	
B: Overall Height	7 1/4" (184mm)	9 1/4" (237mm)	
C: Swivel Radius	5" (126mm)	6 1/4" (161mm)	

▼ PEDAL SETTINGS

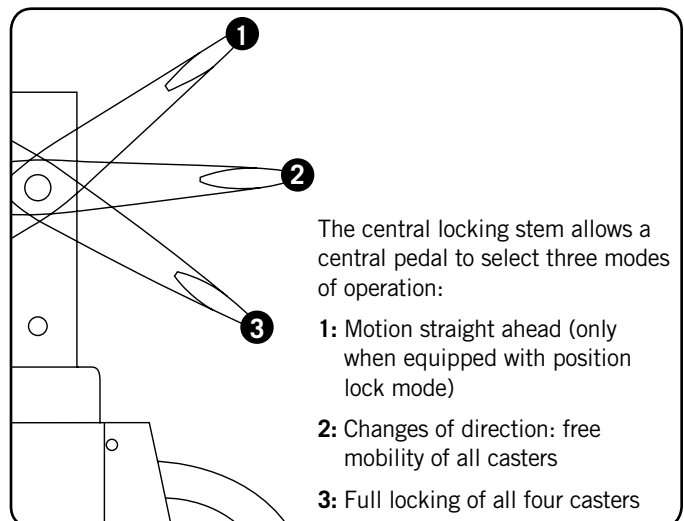

391 & 391+
PRECISION

Also available with precision bearing raceway (Change 390 to 391 in model number).

RHOMBUS



390 & 390+

▼ SPECIFICATIONS

Wheel Diameter	Tread Width	Wheel Material	Wheel Bearing	Load Cap (lb)	Stem (78.5mm)	EDP	Stem (34mm)	EDP
3" (80mm)	1 1/4" (32mm)	TPR	Precision	220	390Q35K080RZ2351	06698	390Q35K080RZ985	02128
3" (80mm)	1 1/4" (32mm)	TPR	Precision	220	390R35K080RZ2351	02014	390R35K080RZ985	02132
4" (100mm)	1 1/4" (32mm)	TPR	Precision	220	390Q35K100RZ2351	02010	390Q35K100RZ985	02129
4" (100mm)	1 1/4" (32mm)	TPR	Precision	220	390R35K100RZ2351	02015	390R35K100RZ985	02133
5" (125mm)	1 1/4" (32mm)	TPR	Precision	220	390Q35K125RZ2351	06680	390Q35K125RZ985	06027
5" (125mm)	1 1/4" (32mm)	TPR	Precision	220	390R35K125RZ2351	06681	390R35K125RZ985	02134
6" (150mm)	1 1/4" (32mm)	TPR	Precision	220	390Q35K150RZ2351	02012	390Q35K150RZ985	02130
6" (150mm)	1 1/4" (32mm)	TPR	Precision	220	390R35K150RZ2351	02017	390R35K150RZ985	02135
8" (200mm)	1 1/4" (32mm)	TPR	Precision	220	390Q35K200RZ2351	02013	390Q35K200RZ985	02131
8" (200mm)	1 1/4" (32mm)	TPR	Precision	220	390R35K200RZ2351	02018	390R35K200RZ985	02136

The measurements in millimeters are exact.

↑ To order 32C wheel change 35K to 32C.

Also available with precision bearing raceway (Change 390 to 391 in model number).

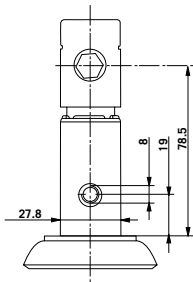

- Stem diameter 27.8mm
- Two locking hole options available
- Locking hole in line or across direction of travel
- Four fixing holes
- Snap-on adapter sleeves available for different tube dimensions

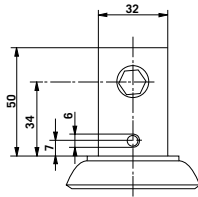

- Stem diameter 32mm
- Two locking hole options available
- Locking hole in line or across direction of travel
- Four fixing holes

▼ COVER OPTIONS



▼ MOUNTING OPTIONS



▼ WHEEL OPTIONS

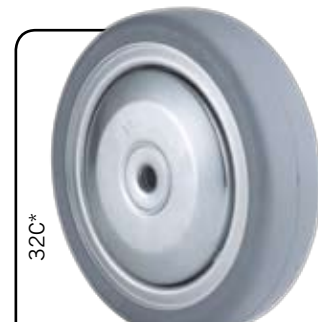

For grey rubber on metal disk change 35K to 32C

RHOMBUS



367 & 364

APPLICATIONS

- Care beds
- Medical-technical equipment
- Physical therapy equipment
- Rehab apparatus

FEATURES

- Stamped and drawn horn assembly
- Zinc-plated
- Double ball raceway that's sealed

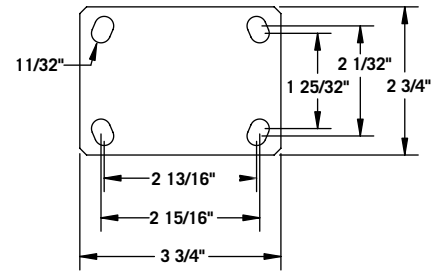

367 SERIES PF

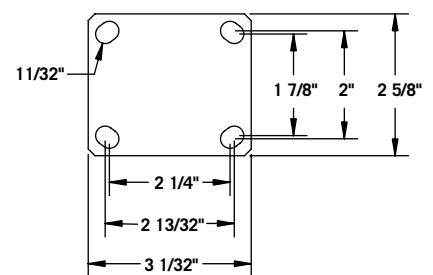
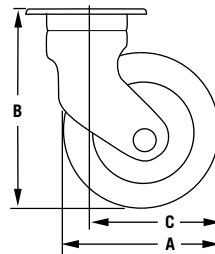

367 SERIES PD

▼ DIMENSIONS

367/364 Series with Top Plate

A: Wheel Diameter	3" (80mm)	4" (100mm)	5" (125mm)	6" (150mm)
B: Overall Height	4 1/2" (117mm)	5 1/4" (137mm)	6 1/2" (163mm)	7 1/2" (189mm)
C: Swivel Radius	3 1/4" (84mm)	3 1/2" (92mm)	3 1/4" (85mm)	4" (100mm)
C: Swivel Radius w/ brake	4" (100mm)	4 1/4" (106mm)	4 1/2" (110mm)	4 1/2" (110mm)

▼ MOUNTING OPTIONS



Hollow Kingpin
LD: 12mm, LU: 1/2"



Expansion Stem*



RHOMBUS



367 & 364

▼ SPECIFICATIONS

Wheel Diameter	Tread Width	Wheel Material	Wheel Bearing	Load Cap (lb)	Top Plate Caster	Top Plate EDP	Hollow Kingpin Caster	Hollow Kingpin EDP
3" (80mm)	1 1/4" (32mm)	TPR	Precision	220	364A35K080RZPF	07276		
3" (80mm)	1 1/4" (32mm)	TPR	Precision	220	367A35K080RZPF	07395	367A35K080RZLD	06304
3" (80mm)	1 1/4" (32mm)	TPR	Precision	220	367H35K080RZPF	08029	367H35K080RZLD	06245
3" (80mm)	1 1/4" (32mm)	TPR	Precision	220	367R35K080RZPF	06111		
4" (100mm)	1 1/4" (32mm)	TPR	Precision	220	364A35K100RZPF	07340		
4" (100mm)	1 1/4" (32mm)	TPR	Precision	220	367A35K100RZPF	07488	367A35K100RZLD	06307
4" (100mm)	1 1/4" (32mm)	TPR	Precision	220	367H35K100RZPF	07986	367H35K100RZLD	06306
4" (100mm)	1 1/4" (32mm)	TPR	Precision	220	367R35K100RZPF	06112		
5" (125mm)	1 1/4" (32mm)	TPR	Precision	220	364A35K125RZPF	07356		
5" (125mm)	1 1/4" (32mm)	TPR	Precision	220	367A35K125RZPF	07571	367A35K125RZLD	07571
5" (125mm)	1 1/4" (32mm)	TPR	Precision	220	367H35K125RZPF	08015	367H35K125RZLD	06309
5" (125mm)	1 1/4" (32mm)	TPR	Precision	220	367R35K125RZPF	06113		
6" (150mm)	1 1/4" (32mm)	TPR	Precision	220	364A35K150RZPF	07298		
6" (150mm)	1 1/4" (32mm)	TPR	Precision	220	367A35K150RZPF	07612	367A35K150RZLD	02109
6" (150mm)	1 1/4" (32mm)	TPR	Precision	220	367H35K150RZPF	08074	367H35K150RZLD	02113
6" (150mm)	1 1/4" (32mm)	TPR	Precision	220	367R35K150RZPF	06124		

The measurements in millimeters are exact.

↑
To order 32C wheel change 35K to 32C.

▼ WHEEL OPTIONS

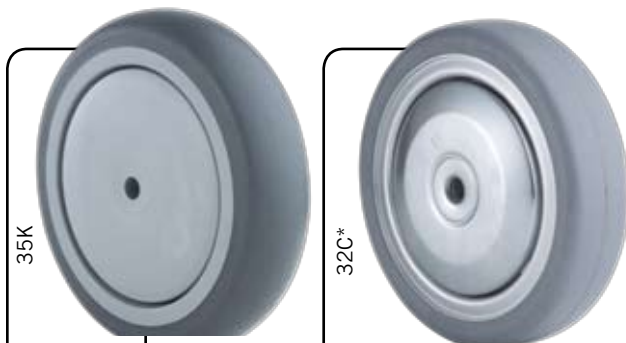

For grey rubber on metal disk change 35K to 32C

▼ LOCK OPTIONS

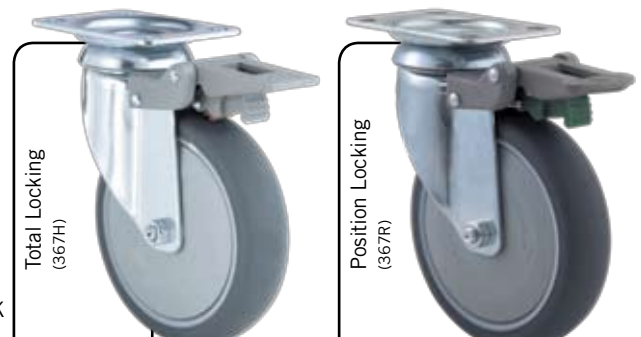

WHEELS

NEOTEQ (CN)



- **Tread:** Neoprene Rubber
- **Core:** Chrome Thread Guard
- **Temperature Range:** -30°F to +175°F
- **Hardness:** 65 (±5) Shore A

Wheel Diameter (Inches)	Tread Width (Inches)	Capacity (Lbs)	Bearing	Fits Axle Size (Inches)	Model Number
2	1	125	Precision Ball	5/16	CN-02NRP-100-05
2-1/2	1	160	Precision Ball	5/16	CN-25NRP-100-05
3	1	175	Precision Ball	5/16	CN-03NRP-100-05

RAZER (RZ)



- **Tread:** TPR
- **Side:** Metal Thread Guard
- **Temperature Range:** -30°F to +180°F
- **Hardness:** 85 (±5) Shore A

TPR (TP) Grey Rubber (GR)

Wheel Diameter (Inches)	Tread Width (Inches)	Capacity (Lbs)	Bearing	Fits Axle Size (Inches)	Model Number
New RZ Grey TPR (TP) Wheels					
2	3/4	110	Plain	5/16	RZ-02TPN-070-05
3	7/8	140	Ball	5/16	RZ-03TPP-090-05
4	7/8	160	Ball	5/16	RZ-04TPP-090-05
5	7/8	165	Ball	5/16	RZ-05TPP-090-05
New RZ Grey Rubber (GR) Wheels					
2	3/4	110	Plain	5/16	RZ-02GRN-070-05
3	7/8	140	Ball	5/16	RZ-03GRP-090-05
4	7/8	160	Ball	5/16	RZ-04GRP-090-05
5	7/8	165	Ball	5/16	RZ-05GRP-090-05

CHROME HOSPITAL (CH) STAINLESS STEEL (SS)

THERMOPLASTIC RUBBER



- **Tread:** TPR
- **Side:** Plastic Thread Guard
- **Temperature Range:** -30°F to +210°F
- **Hardness:** 85 (±5) Shore A

Wheel Diameter (Inches)	Tread Width (Inches)	Capacity (Lbs)	Bearing	Fits Axle Size (Inches)	Model Number
3	1-1/4	190	Precision Ball	5/16	CH-03TPP-125-05
4	1-1/4	240	Precision Ball	5/16	CH-04TPP-125-05
5	1-1/4	260	Precision Ball	5/16	CH-05TPP-125-05
6	1-1/4	260	Precision Ball	5/16	CH-03TPP-125-05

ANTI-MICROBIAL TPR



- **Tread:** Anti-microbial TPR
- **Side:** Plastic Thread Guard
- **Temperature Range:** -30°F to +210°F
- **Hardness:** 85 (±5) Shore A

Wheel Diameter (Inches)	Tread Width (Inches)	Capacity (Lbs)	Bearing	Fits Axle Size (Inches)	Model Number
3	1-1/4	190	Precision Ball	5/16	CH-03AMP-125-05
4	1-1/4	240	Precision Ball	5/16	CH-04AMP-125-05
5	1-1/4	260	Precision Ball	5/16	CH-05AMP-125-05
6	1-1/4	260	Precision Ball	5/16	CH-06AMP-125-05

NEOPRENE RUBBER



- **Tread:** Neoprene
- **Side:** Plastic Thread Guard
- **Temperature Range:** -30°F to +175°F
- **Hardness:** 64 (±5) Shore A

Wheel Diameter (mm)	Tread Width (Inches)	Capacity (Lbs)	Bearing	Fits Axle Size (Inches)	Model Number
100	1-1/4	250	Precision Ball	5/16	CS-04NRP-125-05
100	1-1/4	250	Precision Ball	3/8	CS-04NRP-125-06
125	1-1/4	300	Precision Ball	5/16	CS-05NRP-125-05
125	1-1/4	300	Precision Ball	3/8	CS-05NRP-125-06

POLYURETHANE TPU



- **Tread:** TPR Polyurethane
- **Side:** Plastic Thread Guard
- **Temperature Range:** -30°F to +180°F
- **Hardness:** 95 (±5) Shore A

Wheel Diameter (Inches)	Tread Width (Inches)	Capacity (Lbs)	Bearing	Fits Axle Size (Inches)	Model Number
3	1-1/4	165	Precision Ball	5/16	CH-03PYP-125-05
4	1-1/4	190	Precision Ball	5/16	CH-04PYP-125-05
5	1-1/4	220	Precision Ball	5/16	CH-05PYP-125-05
6	1-1/4	240	Precision Ball	5/16	CH-06PYP-125-05

WHEELS

NYLON (NG) AND NYLON PLUS STAINLESS (NS)

QUICKSTART TPR



- **Tread:** TPR
- **Side:** Integrated Thread Guard
- **Temperature Range:** -30°F to +180°F
- **Hardness:** 70 (±5) Shore A

Wheel Diameter (Inches)	Tread Width (Inches)	Capacity (Lbs)	Bearing	Fits Axle Size (Inches)	Model Number
3	1-1/4	200	Precision Ball	5/16	NG-03QDP-125-05
4	1-1/4	275	Precision Ball	5/16	NG-04QDP-125-05
5	1-1/4	325	Precision Ball	5/16	NG-05QDP-125-05
6	1-1/4	325	Precision Ball	5/16	NG-06QDP-125-05

ANTI-MICROBIAL TPR



- **Tread:** Antimicrobial TPR
- **Side:** Integrated Thread Guard
- **Temperature Range:** -30°F to +180°F
- **Hardness:** 70 (±5) Shore A

Wheel Diameter (Inches)	Tread Width (Inches)	Capacity (Lbs)	Bearing	Fits Axle Size (Inches)	Model Number
3	1-1/4	200	Precision Ball	5/16	NG-03AMP-125-05
4	1-1/4	275	Precision Ball	5/16	NG-04AMP-125-05
5	1-1/4	325	Precision Ball	5/16	NG-05AMP-125-05
6	1-1/4	325	Precision Ball	5/16	NG-06AMP-125-05

PLASTIC (PG)

RUBBER ON PLASTIC



- **Tread:** Rubber/Santoprene
- **Side:** Integrated Thread Guard
- **Temperature Range:** -30°F to +210°F
- **Hardness:** 85 (±5) Shore A

Wheel Diameter (Inches)	Tread Width (Inches)	Capacity (Lbs)	Bearing	Fits Axle Size (Inches)	Model Number
4	1-1/4	220	Precision Ball	5/16	PG-04RPP-125-05
5	1-1/4	220	Precision Ball	5/16	PG-05RPP-125-05
6	1-1/4	264	Precision Ball	5/16	PG-06RPP-125-05
8	1-1/4	264	Precision Ball	5/16	PG-08RPP-125-05

ANTI-STATIC PLASTIC (PA)

ANTI-STATIC POLYURETHANE TPU



- **Tread:** Polyurethane
- **Side:** Plastic Thread Guard
- **Temperature Range:** -30°F to +180°F
- **Hardness:** 95 (±5) Shore A

Wheel Diameter (Inches)	Tread Width (Inches)	Capacity (Lbs)	Bearing	Fits Axle Size (Inches)	Model Number
4	1-1/4	220	Precision Ball	5/16	PA-04APP-125-05
5	1-1/4	220	Precision Ball	5/16	PA-05APP-125-05
6	1-1/4	264	Precision Ball	5/16	PA-06APP-125-05
8	1-1/4	264	Precision Ball	5/16	PA-08APP-125-05

CHROME STEEL (CS)

THERMOPLASTIC RUBBER



- **Tread:** TPR
- **Side:** Plastic Thread Guard
- **Temperature Range:** -30°F to +210°F
- **Hardness:** 85 (±5) Shore A

Wheel Diameter (mm)	Tread Width (Inches)	Capacity (Lbs)	Bearing	Fits Axle Size (Inches)	Model Number
100	1-1/4	240	Precision Ball	5/16	CS-04TPP-125-05
100	1-1/4	240	Plain	5/16	CS-04TPO-125-05
125	1-1/4	260	Precision Ball	5/16	CS-05TPP-125-05
125	1-1/4	260	Plain	5/16	CS-05TPO-125-05

AC AUTOCLAVE (SS)

DESIGNED FOR MOST AUTOCLAVE APPLICATIONS

NEW



- **Tread:** TPR
- Hytrel on autoclaveable PP
- **Temperature Range:** -30°F to +250°F
- **Hardness:** 92 (±5) Shore A

Wheel Diameter (mm)	Tread Width (Inches)	Capacity (Lbs)	Bearing*	Fits Axle Size (Inches)	Model Number
4	1-1/4	275	Precision Ball	3/8	SS-04HSP-125-06
5	1-1/4	300	Precision Ball	3/8	SS-05HSP-125-06
6	1-1/4	325	Precision Ball	3/8	SS-06HSP-125-06

*SS precision ball bearings are stainless steel!

WHEELS

2" TREAD WIDTH WHEELS

SOLID URETHANE



- **Tread:** High strength urethane compound
- **Steam cleanable**
- **Temperature Range:** -50°F to +180°F
- **Hardness:** 55 (±5) Shore D

Wheel Diameter (Inches)	Tread Width (Inches)	Capacity (Lbs)	Bearing	Fits Axle Size (Inches)	Model Number
4	2	700	Delrin	3/4	SS-04PYD-200-12
4	2	700	Roller	3/4	SS-04PYR-200-12
4	2	700	Precision Ball	3/4	SS-04PYP-200-12
5	2	1000	Delrin	3/4	SS-05PYD-200-12
5	2	1000	Roller	3/4	SS-05PYR-200-12
5	2	1000	Precision Ball	3/4	SS-05PYP-200-12
6	2	1200	Delrin	3/4	SS-06PYD-200-12
6	2	1200	Roller	3/4	SS-06PYR-200-12
6	2	1200	Precision Ball	3/4	SS-06PYP-200-12
8	2	1500	Delrin	3/4	SS-08PYD-200-12
8	2	1500	Roller	3/4	SS-08PYR-200-12
8	2	1500	Precision Ball	3/4	SS-08PYP-200-12

MEDEAGLE

NEW



- **Tread:** Polyurethane
- **Temperature Range:** -40°F to +180°F
- **Hardness:** 90 (±5) Shore A

Wheel Diameter (Inches)	Tread Width (Inches)	Capacity (Lbs)	Bearing	Fits Axle Size (Inches)	Model Number
4	2	600	Delrin	3/4	SS-04EPD-200-12
4	2	600	Roller	3/4	SS-04EPR-200-12
4	2	600	Precision Ball	3/4	SS-04EPP-200-12
5	2	900	Delrin	3/4	SS-05EPD-200-12
5	2	900	Roller	3/4	SS-05EPR-200-12
5	2	900	Precision Ball	3/4	SS-05EPP-200-12
6	2	1100	Delrin	3/4	SS-06EPD-200-12
6	2	1100	Roller	3/4	SS-06EPR-200-12
6	2	1100	Precision Ball	3/4	SS-06EPP-200-12
8	2	1200	Delrin	3/4	SS-08EPD-200-12
8	2	1200	Roller	3/4	SS-08EPR-200-12
8	2	1200	Precision Ball	3/4	SS-08EPP-200-12

Note: Stainless and Delrin spanners available: SS= Stainless and SSD = Delrin
 SS200 Spanner: 1/2" x 3/4" x 2-7/16" • SSD200 Spanner: 1/2" x 3/4" x 2-7/16"

WHITE POLYOLEFIN



- **Tread:** Polyolefin
- **Temperature Range:** -20°F to +180°F
- **Hardness:** 65 (±5) Shore D

Wheel Diameter (Inches)	Tread Width (Inches)	Capacity (Lbs)	Bearing	Fits Axle Size (Inches)	Model Number
4	2	550	Delrin	3/4	SS-04PWD-200-12
4	2	550	Roller	3/4	SS-04PWR-200-12
4	2	550	Precision Ball	3/4	SS-04PWP-200-12
5	2	650	Delrin	3/4	SS-05PWD-200-12
5	2	650	Roller	3/4	SS-05PWR-200-12
5	2	650	Precision Ball	3/4	SS-05PWP-200-12
6	2	700	Delrin	3/4	SS-06PWD-200-12
6	2	700	Roller	3/4	SS-06PWR-200-12
6	2	700	Precision Ball	3/4	SS-06PWP-200-12
8	2	800	Delrin	3/4	SS-08PWD-200-12
8	2	800	Roller	3/4	SS-08PWR-200-12
8	2	800	Precision Ball	3/4	SS-08PWP-200-12

NYLON



Wheel Diameter (Inches)	Tread Width (Inches)	Capacity (Lbs)	Bearing	Fits Axle Size (Inches)	Model Number
4	2	800	Delrin	3/4	SS-04NYD-200-12
4	2	800	Roller	3/4	SS-04NYR-200-12
4	2	800	Precision Ball	3/4	SS-04NYP-200-12
5	2	900	Delrin	3/4	SS-05NYD-200-12
5	2	900	Roller	3/4	SS-05NYR-200-12
5	2	900	Precision Ball	3/4	SS-05NYP-200-12
6	2	900	Delrin	3/4	SS-06NYD-200-12
6	2	900	Roller	3/4	SS-06NYR-200-12
6	2	900	Precision Ball	3/4	SS-06NYP-200-12
8	2	900	Delrin	3/4	SS-08NYD-200-12
8	2	900	Roller	3/4	SS-08NYR-200-12
8	2	900	Precision Ball	3/4	SS-08NYP-200-12

HOSPITAL BED REPLACEMENT WHEELS

HOSPITAL BED REPLACEMENT WHEELS (HP)

RUBBER ON PLASTIC



- **Tread:** Rubber
- **Side:** Integrated Thread Guard
- **Temperature Range:** -30°F to +160°F
- **Hardness:** 85 (±5) Shore A

Wheel Diameter (Inches)	Tread Width (Inches)	Capacity (Lbs)	Bearing	Fits Axle Size (Inches)	Model Number
4	1-1/4	198	Precision Ball	5/16	HP-04RPP-125-05
5	1-1/4	220	Precision Ball	5/16	HP-05RPP-125-05
6	1-1/4	220	Precision Ball	5/16	HP-06RPP-125-05
8	1-1/4	264	Precision Ball	5/16	HP-08RPP-125-05

POLYURETHANE



- **Tread:** Polyurethane
- **Side:** Integrated Thread Guard
- **Temperature Range:** -30°F to +180°F
- **Hardness:** 95 (±5) Shore A

Wheel Diameter (Inches)	Tread Width (Inches)	Capacity (Lbs)	Bearing	Fits Axle Size (Inches)	Model Number
4	1-1/4	198	Precision Ball	5/16	HP-04PYP-125-05
5	1-1/4	220	Precision Ball	5/16	HP-05PYP-125-05
6	1-1/4	220	Precision Ball	5/16	HP-06PYP-125-05
8	1-1/4	264	Precision Ball	5/16	HP-08PYP-125-05

HOSPITAL BED REPLACEMENT WHEELS (HC), (HS) AND (MB)

RUBBER ON PLASTIC



- **Tread:** Rubber
- **Side:** Bright Chrome Thread Guard
- **Temperature Range:** -30°F to +160°F
- **Hardness:** 85 (±5) Shore A

Wheel Diameter (Inches)	Tread Width (Inches)	Capacity (Lbs)	Bearing	Fits Axle Size (Inches)	Model Number
4	1-1/4	198	Precision Ball	5/16	HC-04RPP-125-05
5	1-1/4	220	Precision Ball	5/16	HC-05RPP-125-05
6	1-1/4	220	Precision Ball	5/16	HC-06RPP-125-05
8	1-1/4	264	Precision Ball	5/16	HC-08RPP-125-05

POLYURETHANE



- **Tread:** Polyurethane
- **Side:** Bright Chrome Thread Guard
- **Temperature Range:** -30°F to +180°F
- **Hardness:** 95 (±5) Shore A

Wheel Diameter (Inches)	Tread Width (Inches)	Capacity (Lbs)	Bearing	Fits Axle Size (Inches)	Model Number
4	1-1/4	198	Precision Ball	5/16	HC-04PYP-125-05
5	1-1/4	220	Precision Ball	5/16	HC-05PYP-125-05
6	1-1/4	220	Precision Ball	5/16	HC-06PYP-125-05
8	1-1/4	264	Precision Ball	5/16	HC-08PYP-125-05

POLYURETHANE ANTI-STATIC



- **Tread:** Polyurethane Anti-static (Yellow Dot)
- **Side:** Bright Chrome Thread Guard
- **Temperature Range:** -30°F to +180°F
- **Hardness:** 95 (±5) Shore A

Wheel Diameter (Inches)	Tread Width (Inches)	Capacity (Lbs)	Bearing	Fits Axle Size (Inches)	Model Number
4	1-1/4	198	Precision Ball	5/16	HC-04APP-125-05
5	1-1/4	220	Precision Ball	5/16	HC-05APP-125-05
6	1-1/4	220	Precision Ball	5/16	HC-06APP-125-05
8	1-1/4	264	Precision Ball	5/16	HC-08APP-125-05

MEDBED REPLACEMENT



- **Tread:** TPP and PYP
- **Side:** Plastic thread guard

Wheel Diameter (Inches)	Tread Width (Inches)	Capacity (Lbs)	Bearing	Fits Axle Size (Inches)	Model Number
4	1-1/4	198	Precision Ball	5/16	MB-04TPP-125-05
5	1-1/4	220	Precision Ball	5/16	MB-05TPP-125-05
8	1-1/4	264	Precision Ball	5/16	MB-08PYP-125-05

WHEEL CHAIR CASTERS/WHEELS (WC) (WW)



APPLICATIONS

- Wheel chairs

Other sizes available. Consult factory

FEATURES

- New versatile chair replacement fork
- New front wheel chair wheels
- WC front wheel chair casters feature durable reinforced nylon construction
- Rear wheel chair casters now come in black or grey

VERSATILE FRONT WHEEL CHAIR REPLACEMENT FORK

Description	Model Number
Versatile durable light weight aluminum design fits wheels from 6" to 12" diameter wheels. Three holes allow you to choose the appropriate axle installation for desired wheel diameter. Designed for 2" tread width or less. 1/2" diameter threaded stem x 2-5/8" long.	WC-8200-SW-TS22



WHEEL CHAIR REPLACEMENT WHEELS

Wheel Diameter Inches (mm)	Tread Width Inches (mm)	Wheel Description	Capacity (Lbs)	Wheel Bearing	Fits Axle Size (mm)	Model Number
6" (150)	1-1/4" (32)	Black Polyurethane	80	Precision Ball	8mm	WW-06PBP125-8M
8" (200)	1-1/4" (32)	Grey Polyurethane	88	Precision Ball	8mm	WW-08PGP125-8M
8" (200)	1-5/8" (41)	Black Polyurethane	88	Precision Ball	8mm	WW-08PBP165-8M
12" (305)	2" (51)	Grey Polyurethane	132	Precision Ball	12mm	WW-12PGP165-12M



WC FRONT WHEEL CHAIR CASTERS

Wheel Diameter Inches (mm)	Tread Width Inches (mm)	Wheel Description	Capacity (Lbs)	Load Height Inches (mm)	Swivel Radius Inches (mm)	Wheel Bearing	Model Number
7-1/2" (190)	1-1/16" (27)	Polyurethane	88	9-1/4" (235mm)	5-1/2" (140mm)	Needle	WC-75PYR106-SW-TS17
7-7/8" (200)	1-1/16" (27)	Polyurethane	88	9-29/64" (240mm)	5-3/4" (146mm)	Needle	WC-77PYR106-SW-TS17

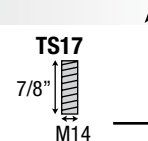

WHEEL CHAIR REAR

Wheel Diameter Inches (mm)	Tread Width Inches (mm)	Wheel Description	Capacity (Lbs)	Hub Width Inches (mm)	Bore Size (mm)	Wheel Bearing	Model Number
24" (609)	1-3/16" (30)	PU Black	132	2-1/8" (54)	12mm	Precision Ball	WW-024PBP118-12M32
24" (609)	1-3/16" (30)	PU Black	132	2-1/8" (54)	12mm	Precision Ball	WW-024PBP118-12M37



Available in black or grey. Consult factory.

BUMPERS



End Bumper EB-1

Grey end bumper generally used on the ends of tubular handles; 3-1/4" diameter with steel insert for 5/16" bolt.



Corner Bumper CB-8

Grey corner bumper for mounting on flat surfaces. 7/8" thick x 1" high x 2-5/8" long from inside corner.



Corner Bumper CB-10

Grey corner bumper for mounting on flat surfaces; ends of legs are tapered, with steel inserts. 1" thick x 1-1/16" high x 3-1/16" long from inside corner.



Corner Bumper CB-12

Grey corner bumper for mounting on flat surfaces; ends of legs may be cut at notched area to make square ends, with steel inserts. 7/8" thick x 1" high x 3-1/8" long from inside corner.



Tubing Bumper B-3-1/2

3-1/2" diameter bumper fits 1" O.D. round (TB3.5R) or square (TB3.5S) tubing



Rolling Bumper RB-5 & RB-7

5" and 7" diameter rolling bumpers; tapered grey rubber bonded to a zinc-plated insert with removable center bushings to fit diameters from 3/8" to 1-1/8"

CASTER SOCKETS AND HARDWARE

NEW

CASTER SOCKETS (ROUND & SQUARE)

Model Number	Tube Size	Tube ID	Socket Size	Grip Ring Size	Description
SCKT92	Round 1" x 16 gauge	.870"	.887" diameter	7/16"	Black nylon 2-5/16" long
SCKT94	Round 1" x 18 gauge	.902"	.912" diameter	7/16"	Black nylon 2-5/16" long
SCKT96	Round 1-1/4" x 16 gauge	1.120"	1.140" diameter	7/16"	Black nylon 2-5/16" long
SCKT22	Square 1-1/2" x 7 gauge	1.140"	1.154" square	7/16"	Brown nylon 2-1/4" long
SCKT18	Square 1" x 18 gauge	.902"	.916" square	7/16"	Black nylon 2-5/16" long



BUSHINGS



Model Number	Description
SSBushing	5/16" x 3/8" x 1-15/32" stainless bushing
CHSPM10	1/2" to M10 reducer busing for CH series HK01



GRIP RING STEM KITS (RZ)

Model Number	Description
RZGR01	7/16" x 7/8" grip ring stem with nut
RZGR02	7/16" x 1-7/16" grip ring stem kit with nut

Note above kits can only be added to 3" and larger Razer (RZ) HK04 casters.

AXLES

Model Number	Description
CHAXLE	5/16" axle and nut for (CH) 1-1/4" wide series
SSAXLE	Stainless steel 5/16" axle and nut for (SS) 1-1/4" wide series

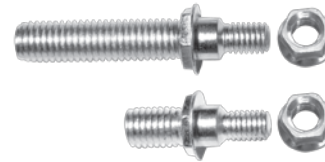

THREADED STEM KITS (CH)

Model Number	Description
CHTS01	1/2"-13 x 3/4" threaded stem kit with nut
CHTS02	1/2"-13 x 1" threaded stem kit with lock nut (CH Series)
CHTS03	1/2"-13 x 1-1/2" threaded stem kit with lock nut (CH Series)
CHTS04	1/2"-13 x 2" threaded stem kit with nut (CH Series)

Note: Above kits can only be added to CH HK01 casters.

THREADED STEM KITS (RZ)

Model Number	Description
RZTS06	3/8"-16 x 1" threaded stem kit with nut
RZTS25	3/6"-16 x 1-1/2" threaded stem kit with nut
RZTS15	M10 x 15mm threaded stem kits with nut

Note: Above kits can only be added to 3" and larger Razer (RZ) HK04 casters.

SPECIALTY/CONVERSION

SPECIALTY PRODUCTS



Walker Casters and Wheels



400 Series Special Hooded Rhombus



357 Rhombus



398 Rhombus

MedCaster has a complete line of casters and wheels for the medical industry ... yet, sometimes you may need a unique solution for a caster or wheel that you cannot find. Contact us with your requirements.

INCHES TO MILLIMETERS CONVERSION

Inches (Fraction)	Inches (Decimal)	Millimeters	Inches (Fraction)	Inches (Decimal)	Millimeters	Inches (Fraction)	Inches (Decimal)	Millimeters
1/64	0.02	0.40	1/2	0.50	12.69	1	1.00	25.38
1/32	0.03	0.79	33/64	0.52	13.09	2	2.00	50.76
3/64	0.05	1.19	17/32	0.53	13.48	3	3.00	76.14
1/16	0.06	1.59	35/64	0.55	13.88	4	4.00	101.52
5/64	0.08	1.98	9/16	0.56	14.28	5	5.00	126.90
3/32	0.09	2.38	37/64	0.58	14.67	6	6.00	152.28
7/64	0.11	2.78	19/32	0.59	15.07	7	7.00	177.66
1/8	0.13	3.17	39/64	0.61	15.47	8	8.00	203.05
9/64	0.14	3.57	5/8	0.63	15.86	12	12.00	304.57
5/32	0.16	3.97	41/64	0.64	16.26			
11/64	0.17	4.36	21/32	0.66	16.66			
3/16	0.19	4.76	43/64	0.67	17.05			
13/64	0.20	5.16	11/16	0.69	17.45			
7/32	0.22	5.55	45/64	0.70	17.85			
15/64	0.23	5.95	23/32	0.72	18.24			
1/4	0.25	6.35	47/64	0.73	18.64			
17/64	0.27	6.74	3/4	0.75	19.04			
9/32	0.28	7.14	49/64	0.77	19.43			
19/64	0.30	7.53	25/32	0.78	19.83			
5/16	0.31	7.93	51/64	0.80	20.23			
21/64	0.33	8.33	13/16	0.81	20.62			
11/32	0.34	8.72	53/64	0.83	21.02			
23/64	0.36	9.12	27/32	0.84	21.41			
3/8	0.38	9.52	55/64	0.86	21.81			
25/64	0.39	9.91	7/8	0.88	22.21			
13/32	0.41	10.31	57/64	0.89	22.60			
27/64	0.42	10.71	29/32	0.91	23.00			
7/16	0.44	11.10	59/64	0.92	23.40			
29/64	0.45	11.50	15/16	0.94	23.79			
15/32	0.47	11.90	61/64	0.95	24.19			
31/64	0.48	12.29	31/32	0.97	24.59			
			63/64	0.98	24.98			

- **Convert Inches to Millimeters:**
Divide by .0394 (note: this is how above chart was calculated and rounded to hundredths)
- **Convert Millimeters to Inches:**
Multiply by .0394.
- **Convert Kilograms to Pounds:**
Multiply by 2.2046.
- **Convert Pounds to Kilograms:**
Divide by 2.2046.