

FUTURA

Suspension Castors

U.S. Patent US 6,823,560 B2

Our Futura adds another dimension to the meaning of Performance Art. Its patented suspension and braking design is a total revolution in castor industry.

Secluded behind the dynamic casing, is the heart and soul of this innovation: locking and suspension components, all protected within a single piece of steel housing. Braking is acted on the internal surface of the wheel leaving no dent on the tread and markedly reduces the chance for tire damage. All intended to provide your valuable and sensitive equipment with the protection and convenience it needs.

Since the advent of the Futura, major manufacturers in medical diagnostic equipments dare to restructure and upgrade their products, realizing that Futura could move their prized equipments around, without the nagging concern of system breakdown due to vibrations during motion. If your products deserve a TLC mover, this is it!

At Catis, we always look for better solutions.

Applications:

High-end medical diagnostic ultrasound machines; sensitive electronic equipments.

Size available:

150 mm

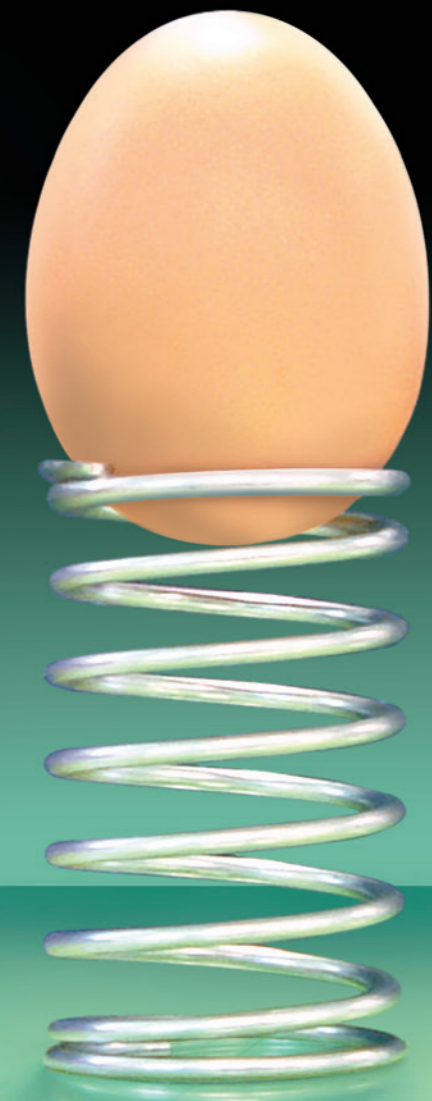
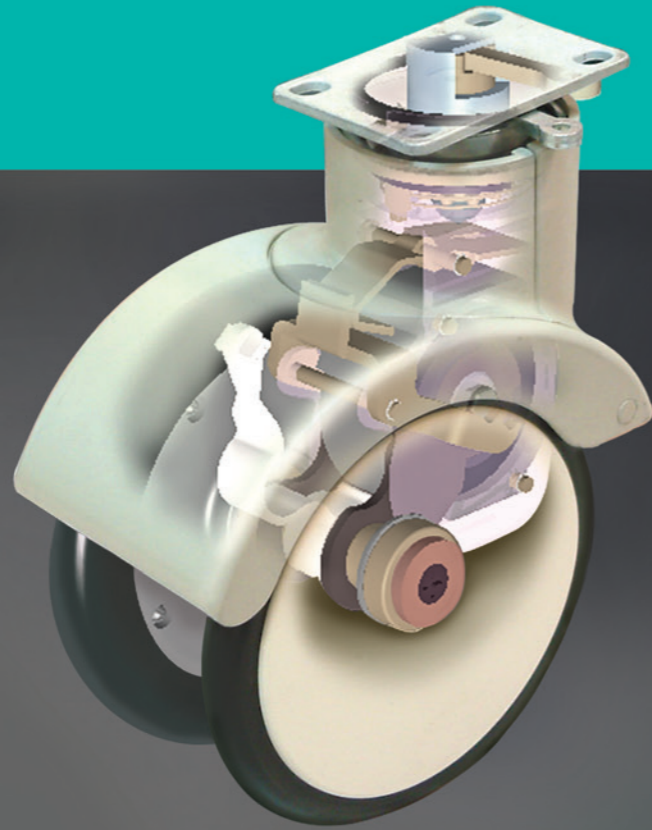

FUTURA

Shock Absorbing Castors





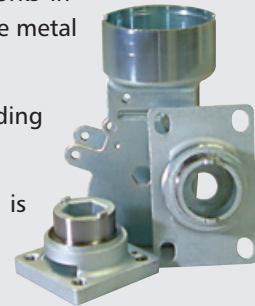

FEATURES

- ABS mud guard, designed to rise and fall with wheel motion, allowing maximum clearance at mounting interface. It is easy to maintain, preventing cable and wire caught in between wheels, and keeps wheels from collecting food spill and dirt. Would not decolorize because color pigment is included in injection process.
- Innovated dual brake design that operates from the inside of the wheel. As braking acts on the internal surface of the wheel, it eliminates abrasion on tread surface, which often leads to wheel damage.

- Precision ball bearings at swivel head and wheel axle warrant quiet transport, and minimize starting and swivel resistance.
- Rubber formulated separately for the twin wheels and patented suspension core works in synergy to provide easy maneuvering, and maximum shock dampening function. Unlike metal spring, rebound is smooth and quiet.
- Exceptional structural strength as yoke, and top plate are mold cast, without any welding weak spot. Zinc plating finish provides long lasting protection.
- Each castor is designed to carry 100kgs (220lbs), but a total load of 300kgs (660lbs) is recommended for the vehicles using 4 castors, as frequently, only 3 castors are in contact with ground surface.



OPTIONS

4 standard colors: Grey  Ivory  Green  and Blue 













4 standard operating modes: Free swivel; (round stem fitting is available to this mode only)

Directional lock / Free swivel









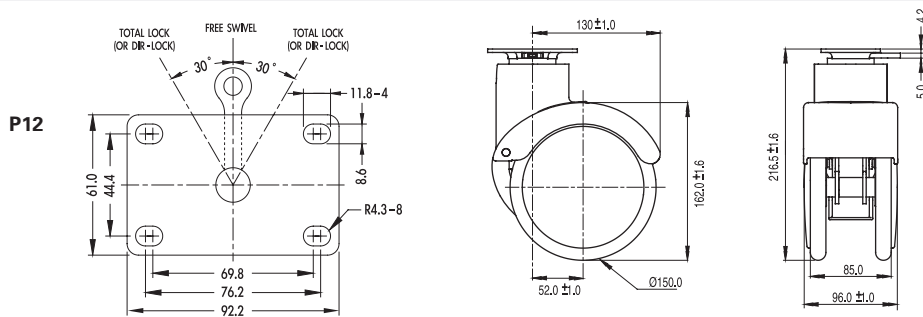



Total lock / Free swivel

Total lock / Free swivel / Directional lock

Color, covers and mounting configuration can be customized to match your equipment (see Custom Made P189).

Brake type	 mm	 mm			 mm	 mm	 mm	 mm	 kg		Code
Total lock	150	16x2		Rubber	P12	52	130	216.5	100	70±5 A	SU150BP12/RB
Dir. lock	150	16x2		Rubber	P12	52	130	216.5	100	70±5 A	SU150DBP12/RB
Non-brake Free swivel	150	16x2		Rubber	P12	52	130	216.5	100	70±5 A	SU150P12/RB



Brake type	 mm	 mm			 mm	 mm	 mm	 mm	 kg		Code
Free swivel Total lock Dir. lock	150	16x2		Rubber	P13	52	130	226.1	100	70±5 A	SU150BBP13/RB
Non-brake Free swivel	150	16x2		Rubber	P13	52	130	226.1	100	70±5 A	SU150P13/RB

