

130

Contender™ Premium Stainless Steel



FEATURES

- **Top Plate:** 5/16" 304 stainless steel and welded construction for longer life
- **Yoke Base:** Notched 316 stainless steel welded inside and out
- **Legs:** 304 stainless steel welded inside and out
- **Swivel Section:** One row of 3/8" ball bearings mounted in a precision machined raceway
- **Axle:** 1/2" diameter hollow axle with zerk fitting on roller and tapered bearing models (Solid axle on Delrin, precision ball, and Oilex models)
- Alternate or custom caster configurations available

RIG OPTIONS

- **Optional Overall heights** of 9 1/2" for 8" wheel diameter models add **-01** to end of model number.

BRAKE OPTIONS

Single Side specify **SSB130**. **Double Sided** specify **DSB130**.

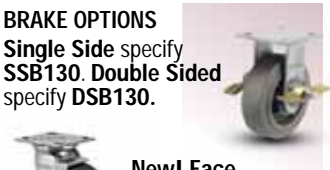

New! Face Brake specify **FBD**

Hand operated field installable swivel lock specify **SL1200000**



Caster features premium grade 304 stainless steel caster rig with a strong premium 316 stainless steel swivel section. The caster is well suited for applications exposed to cleaning agents, steam, caustic solutions, or other corrosive agents which could cause rust.

TYPICAL APPLICATIONS

- Dollies
- Dough troughs
- Platform trucks
- Tow line
- Utility carts
- Tooling fixtures
- Scrap metal carriers

MOUNTING OPTIONS

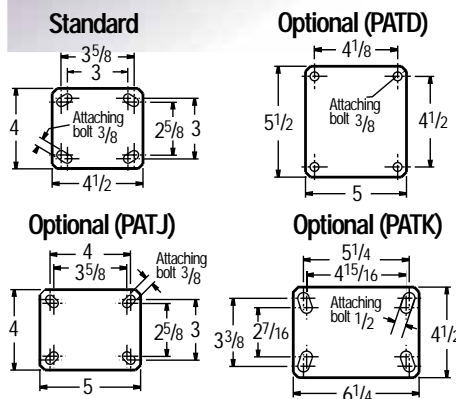

BEARING OPTIONS



For swivel models add "S" to end of caster number.
For rigid models add "R" to end of caster number.

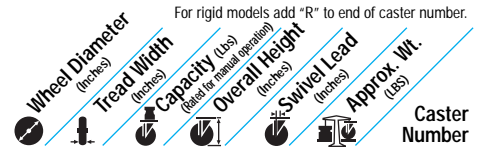
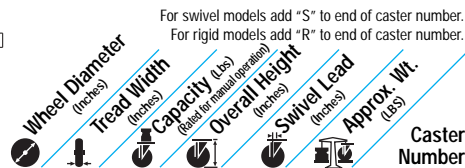
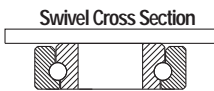

X-tra Soft (Flat Tread) (01 Roller Bearing)*

4	2	350	5 5/8	1 3/16	130XS04201
5	2	375	6 1/2	1 3/8	130XS05201
6	2	600	7 1/2	1 9/16	130XS06201
8	2	675	10 1/8	2 1/4	130XS08201



XS

Prevenz™ antimicrobial models available. Add PREV to end of model.

*Stainless Steel Roller (01 ZB03) and Delrin (51) Bearings available.
Change "01" to other bearing code.
Stainless Steel Roller Example: 130XS04201 ZB03

X-tra Soft Round Tread (01 Roller Bearing)*

6	2	400	7 1/2	1 9/16	130XR06201
8	2	600	10 1/8	2 1/4	130XR08201



XR

Prevenz™ antimicrobial models available. Add PREV to end of model.

*Stainless Steel Roller (01 ZB03) and Delrin (51) Bearings available.
Change "01" to other bearing code.
Stainless Steel Roller Example: 130XR06201 ZB03

High Modulus Rubber on Aluminum (28 Precision Ball Bearing)

NEW MODEL!					
5	2	300	6 1/2	1 3/8	130RM05228
6	2	350	7 1/2	1 9/16	130RM06228
8	2	450	10 1/2	2 1/4	130RM08228

RM

Polypropylene (01 Roller Bearing)*

4	2	450	5 5/8	1 3/16	130PB04201
5	2	650	6 1/2	1 3/8	130PB05201
6	2	750	7 1/2	1 9/16	130PB06201
8	2	1000	10 1/8	2 1/4	130PB08201

PB

White Polypropylene (41 Plain Bore)

NEW MODEL!					
4	2	220	5 5/8	1 3/16	130PW04241
5	2	325	6 1/2	1 3/8	130PW05241
6	2	350	7 1/2	1 9/16	130PW06241

PW

*Stainless Steel Roller (01 ZB03) and Delrin (51) Bearings available.
Change "01" to other bearing code.
Stainless Steel Roller Example: 120XR06201 ZB03

Continue on next page

For swivel models add "S" to end of caster number.
For rigid models add "R" to end of caster number.

Wheel Diameter (Inches) | Tread Width (Inches) | Capacity (Lbs) (Based for manual operation) | Overall Height (Inches) | Swivel Lead (Inches) | Approx. Wt. (Lbs) | Caster Number

High Temp Polypropylene (41 Plain Bore)

4	2	500	5 ⁵ / ₈	1 ³ / ₁₆	130RW04241
5	2	650	6 ¹ / ₂	1 ³ / ₈	130RW05241
6	2	700	7 ¹ / ₂	1 ⁹ / ₁₆	130RW06241
8	2	900	10 ¹ / ₈	2 ¹ / ₄	130RW08241

RW 

Polyurethane on Aluminum Round Tread (28 Precision Ball Bearings)

5	2	1000	6 ¹ / ₂	1 ³ / ₈	130PM05228
6	2	1250	7 ¹ / ₂	1 ⁹ / ₁₆	130PM06228
8	2	1400	10 ¹ / ₈	2 ¹ / ₄	130PM08228

PM 

Polyurethane on Polypropylene (01 Roller Bearing)

4	2	600	5 ⁵ / ₈	1 ³ / ₁₆	130XA04201
5	2	750	6 ¹ / ₂	1 ³ / ₈	130XA05201
6	2	900	7 ¹ / ₂	1 ⁹ / ₁₆	130XA06201
8	2	1000	10 ¹ / ₈	2 ¹ / ₄	130XA08201

Prevenz™ antimicrobial models available. Add PREV to end of model.
*Stainless Steel Roller (01 ZB03) and Delrin (51) Bearings available. Change "01" to other bearing code.
Stainless Steel Roller Example: 130XA04201 ZB03

XA 

X-Treme™ Solid Polyurethane (01 Roller Bearing)*

4	2	1000	5 ⁵ / ₈	1 ³ / ₁₆	130XI04201
5	2	1000	6 ¹ / ₂	1 ³ / ₈	130XI05201
6	2	1000	7 ¹ / ₂	1 ⁹ / ₁₆	130XI06201
8	2	1000	10 ¹ / ₈	2 ¹ / ₄	130XI08201

*Stainless Steel Roller (01 ZB03), Bronze (22), Pedestal Precision (29), Annular Ball (31) and Delrin (51) bearings available. Change "01" to other bearing code. Pedestal Precision example: 130XI04229.

XI 

X-Treme™ Plus Solid Polyurethane (01 Roller Bearing)*

4	2	1400	5 ⁵ / ₈	1 ³ / ₁₆	130XP04201
5	2	1200	6 ¹ / ₂	1 ³ / ₈	130XP05201
6	2	1400	7 ¹ / ₂	1 ⁹ / ₁₆	130XP06201
8	2	1400	10 ¹ / ₈	2 ¹ / ₄	130XP08201

XP 

Phenolic (01 Roller Bearing)

4	2	800	5 ⁵ / ₈	1 ³ / ₁₆	130TM04201
5	2	1000	6 ¹ / ₂	1 ³ / ₈	130TM05201
6	2	1200	7 ¹ / ₂	1 ⁹ / ₁₆	130TM06201
8	2	1400	10 ¹ / ₈	2 ¹ / ₄	130TM08201

*Stainless Steel Roller (01 ZB03) and Delrin (51) Bearings available. Change "01" to other bearing code.
Stainless Steel Roller Example: 130TM06201 ZB03

TM 

Straight Sided Phenolic (01 Roller Bearing)

4	2	1000	5 ⁵ / ₈	1 ³ / ₁₆	130TH04201
5	2	1200	6 ¹ / ₂	1 ³ / ₈	130TH05201
6	2	1400	7 ¹ / ₂	1 ⁹ / ₁₆	130TH06201

TH 

For swivel models add "S" to end of caster number.
For rigid models add "R" to end of caster number.

Wheel Diameter (Inches) | Tread Width (Inches) | Capacity (Lbs) (Based for manual operation) | Overall Height (Inches) | Swivel Lead (Inches) | Approx. Wt. (Lbs) | Caster Number

Maxim® (01 Roller Bearing)*

4	2	800	5 ⁵ / ₈	1 ³ / ₁₆	5	130NG04201
5	2	1000	6 ¹ / ₂	1 ³ / ₈	5 ¹ / ₄	130NG05201
6	2	1200	7 ¹ / ₂	1 ⁹ / ₁₆	5 ³ / ₄	130NG06201
8	2	1400	10 ¹ / ₈	2 ¹ / ₄	7	130NG08201

Prevenz™ antimicrobial models available. Add PREV to end of model.
*Stainless Steel Roller (01 ZB03), Bronze (22), Pedestal Precision (29), Annular Ball (31) and Delrin (51) bearings available. Change "01" to other bearing code. Pedestal Precision example: 130NG04229.

NG 

Maxim® NR Noise Reduction (01 Roller Bearing)*

4	2	800	5 ⁵ / ₈	1 ³ / ₁₆	130NR04201
5	2	1000	6 ¹ / ₂	1 ³ / ₈	130NR05201
6	2	1200	7 ¹ / ₂	1 ⁹ / ₁₆	130NR06201
8	2	1400	10 ¹ / ₈	2 ¹ / ₄	130NR08201

NEW MODEL!

Prevenz™ antimicrobial models available. Add PREV to end of model.
*Stainless Steel Roller (01 ZB03), Bronze (22), Pedestal Precision (29), Annular Ball (31) and Delrin (51) bearings available. Change "01" to other bearing code. Pedestal Precision example: 130NR04229.

NR 

Hi-Temp Nylon (01 Roller Bearing)

4	2	800	5 ⁵ / ₈	1 ³ / ₁₆	130HE04201
5	2	1000	6 ¹ / ₂	1 ³ / ₈	130HE05201
6	2	1200	7 ¹ / ₂	1 ⁹ / ₁₆	130HE06201
8	2	1200	10 ¹ / ₈	2 ¹ / ₄	130HE08201

*Stainless Steel Roller (01 ZB03) bearings available. Change "01" to other bearing code. Example: 130HE04201 ZB03.

HE 

Drop Forged Steel (01 Roller Bearing)*

4	1 ¹ / ₂	1400	5 ⁵ / ₈	1 ³ / ₁₆	130FS04101
5	1 ³ / ₄	1400	6 ¹ / ₂	1 ³ / ₈	130FS05201
6	2	1400	7 ¹ / ₂	1 ⁹ / ₁₆	130FS06201

Stainless steel models available, consult factory.
*Stainless Steel Roller (01 ZB03) bearings available. Change "01" to other bearing code. Example: 130FS04201 ZB03.

FS 

Prevenz™ Antimicrobial Wheels

The EPA registered and FDA compliant antimicrobial additive used in Prevenz™ wheels is designed to suppress the growth of a variety of destructive and odor causing microbes including bacteria, molds, mildew and fungi. These wheels are suitable for a variety of applications including medical equipment, food equipment, pharmaceutical, chemical, meat & poultry, processing plants and more. To order add "PREV" to end of caster number.

XS Prevenz™ | XR Prevenz™ | XA Prevenz™ | NG Prevenz™ | XP Prevenz™

